

Robert G. Byram
Senior Vice President and
Chief Nuclear Officer

PPL Susquehanna, LLC
Two North Ninth Street
Allentown, PA 18101-1179
Tel. 610.774.7502 Fax 610.774.5019
rgbyram@pplweb.com



APR 27 2001

U. S. Nuclear Regulatory Commission
Attn: Document Control Desk
Mail Station OP1-17
Washington, D.C. 20555

**SUSQUEHANNA STEAM ELECTRIC STATION
RADIOACTIVE EFFLUENT RELEASE REPORT
AND OFFSITE DOSE CALCULATION MANUAL
PLA-5303**

**Docket No. 50-387
and 50-388**

In accordance with 10CFR50.36a(a)(2) and the Susquehanna SES Unit 1 and 2 Technical Specifications Section 5.6.3, attached is the annual Radioactive Effluent Release Report for SSES Units 1 and 2 covering the period January 1 through December 31, 2000. Additionally, pursuant to Technical Specification Section 5.5.1.C.3, attached is a copy of the Offsite Dose Calculation Manual as revised through December 31, 2000.

If you have any questions, please contact Mr. Robert D. Kichline at (610) 774-7705.

Sincerely,

A handwritten signature in black ink, appearing to be "R. G. Byram", is written over a horizontal line. The signature is stylized and somewhat cursive.

R. G. Byram

Attachment

copy: NRC Region I
Mr. S. L. Hansell, NRC Sr. Resident Inspector, SSES
Mr. R. G. Schaaf, NRC Sr. Project Manager

*IEPS
A009
4/1*

SUSQUEHANNA STEAM ELECTRIC STATION

ANNUAL EFFLUENT & WASTE DISPOSAL REPORT FOR JANUARY – DECEMBER 2000

**PPL Susquehanna, LLC
Two North Ninth Street
Allentown, Pennsylvania 18101-1179**

April 2001

SUSQUEHANNA STEAM ELECTRIC STATION
ANNUAL EFFLUENT AND WASTE DISPOSAL REPORT

REPORT PERIOD: 01/01/00 - 12/31/00

Prepared by:



R. F. Ely
Nuclear Engineer

Reviewed by:

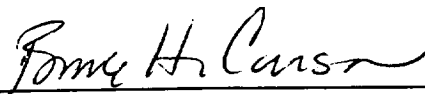

B. H. Carson
Health Physicist

Approved by:



R. L. Doty
Supervisor - Operations Technology

PPL Susquehanna, LLC
Two North Ninth Street, GENA93
Allentown, Pennsylvania 18101

TABLE OF CONTENTS

<u>SECTION</u>	<u>PAGE</u>
1. Introduction and Supplemental Information	1-1
2. Effluent and Waste Disposal Data	2-1
3. Meteorological Data and Dispersion Estimates	3-1
4. Dose Measurements and Assessments	4-1
5. Changes to the Offsite Dose Calculation Manual and the Solid Radioactive Waste Process Control Program	5-1
6. Reports of Exception to the SSES Effluent Monitoring Program	6-1
7. Corrections to Doses Reported in Previous Semiannual or Annual Effluent and Waste Disposal Reports	7-1
8. Effluent from Systems Classified as Insignificant Effluent Pathways	8-1
 Appendix A SSES ODCM	

LIST OF TABLES

	<u>PAGE</u>	
Table 1-1	Technical Requirement Limits	1-9
Table 2-1	Airborne Effluent-Summation of All Releases	2-4
Table 2-2	Airborne Effluent	2-5
Table 2-3	Waterborne Effluent - Summation of All Releases	2-8
Table 2-4	Waterborne Effluent	2-9
Table 2-5	Annual Effluent and Waste Disposal Report Estimated Total Errors Associated with Effluents Measurements Data Period: January 1, 2000 – December 31, 2000	2-12
Table 2-6	Annual Effluent and Waste Disposal Report Solid Waste and Irradiated Fuel Shipments	2-16
Table 2-7	Condensate Demineralizer/Radwaste Demineralizer - Class A Steel Liner (Dewatered)	2-17
Table 2-8	Condensate Demineralizer/Radwaste Demineralizer – Class A Steel Liner (Solidification – Q - CEP)	2-18
Table 2-9	Liquid Radwaste Filter Media – Class A HIC (Dewatered)	2-19
Table 2-10	RWCU Filter Media – Class A HIC (Dewatered)	2-20
Table 2-11	Condensate Filters – Class A Steel Liner (Dewatered)	2-21
Table 2-12	Processed DAW – Class A Strong Tight Container (Compaction)	2-22
Table 2-13	Cartridge Filters – Class A HIC (Dewatered)	2-23
Table 2-14	Liquid Oily Waste (Petroleum-Based Material) – Class A Steel Liner (Fuel Blending for Cogeneration)	2-24

LIST OF TABLES (cont.)

	<u>PAGE</u>	
Table 2-15	Bead Resin – Class A HIC (Pyrolysis)	2-25
Table 2-16	Condensate Filter Backwash – Class A HIC (Dewatered)	2-26
Table 2-17	Irradiated Components – Class B Steel Liner (Dewatered)	2-27
Table 2-18	Irradiated Components – Class C HIC (Dewatered)	2-28
Table 2-19	Non-Processed DAW – Class C HIC	2-29
Table 2-20	Cartridge Filters – Class C HIC (Dewatered)	2-30
Table 2-21	Irradiated Components – Class C Steel Liner (Dewatered)	2-31
Table 3-1	SSES Meteorological Data Recovery for 2000	3-3
Table 3-2	SSES Joint Frequency Distribution of Wind Speed and Direction 10m versus Delta Temperature 60-10m for the Period of January 1, 2000 through December 31, 2000	3-4
Table 3-3	SSES Joint Frequency Distribution of Wind Speed and Direction 60m versus Delta Temperature 60-10m for the Period of January 1, 2000 through December 31, 2000	3-12
Table 3-4	2000 SSES Annual Relative Concentrations No Decay, Undepleted X/Q (sec/m^3)	3-20
Table 3-5	2000 SSES Annual Relative Concentrations 2.26-Day Decay, Undepleted X/Q (sec/m^3)	3-21
Table 3-6	2000 SSES Annual Relative Concentrations 8-Day Decay, Depleted X/Q (sec/m^3)	3-22
Table 3-7	2000 SSES Annual Relative Deposition – D/Q (meters^{-2})	3-23
Table 3-8	2000 Atmospheric Dispersion Estimates for GASPAR Input at Selected Locations	3-24

LIST OF TABLES (cont.)

		<u>PAGE</u>
Table 4-1	Site-Specific Parameters Used for Laptap II Calculations (Danville Receiver): for 2000	4-2
Table 4-2	Summary of Maximum Individual Offsite Doses and Dose Commitments to Members of the Public	4-4
Table 4-3	Calculated Collective Doses to Members of the Public Within the Riverlands/Information Center Complex	4-5
Table 4-4	Calculated Doses for Individuals and Locations within the SSES Site Boundary and Nearest Dairy	4-6
Table 8-1	Annual Release from Systems Classified as Insignificant Effluent Pathways	8-2

LIST OF FIGURES

	<u>PAGE</u>
Figure 1-1 SSES Airborne Effluent Points	1-5
Figure 1-2 SSES Waterborne Effluent Pathway	1-6
Figure 2-1 Susquehanna River Monthly Average Flow Rates	2-10
Figure 2-2 SSES Monthly Liquid Radwaste Discharge Totals	2-11
Figure 3-1 SSES 2000 Annual Wind Rose: 10-Meter Level Primary Tower	3-26
Figure 3-2 SSES 2000 Annual Wind Rose: 60-Meter Level Primary Tower	3-27
Figure 3-3 SSES Pasquill Stability Class Prevalences	3-28
Figure 4-1 Locations for which Airborne Dose Calculations are Performed	4-7

SECTION 1

INTRODUCTION AND SUPPLEMENTAL INFORMATION

INTRODUCTION

The Susquehanna Steam Electric Station (SSES) is located in Salem Township, Luzerne County, Pennsylvania. It is on the west bank of the Susquehanna River, 8 km northeast of Berwick. The Station consists of two boiling water reactor generating units, each with about 1,100 MW net electrical capacity. The reactor and generating units were supplied by General Electric, while the Bechtel Corporation served as architect-engineer and constructor.

Construction of the Station began in the early 1970s. Fuel load began in Unit 1 in July of 1982. Initial criticality was achieved in the Unit 1 reactor on September 10, 1982. The reactor reached 100% power for the first time on February 4, 1983. Commercial operation of Unit 1 was declared on June 8, 1983. Initial criticality of Unit 2 occurred on May 8, 1984. Unit 2 was declared commercial on February 12, 1985.

Airborne effluents are released from the Susquehanna Station via five rooftop vents on the reactor building (see Figure 1-1). Each vent is continuously monitored, and a program of periodic sampling and analysis is conducted as specified in the plant Technical Requirements. All waterborne effluents are released in batch mode and are sampled and analyzed prior to release. Waterborne effluents from the site are released into the cooling tower blowdown line for dilution prior to release to the Susquehanna River (see Figure 1-2). Blowdown line flow rates are at least 5,000 gpm during periods of liquid radwaste release. The diluted effluent is introduced to the river by way of a perforated diffuser pipe placed on the river bed. The diffuser serves to rapidly and uniformly mix the station discharge with the main flow of the river.

This report presents a summary of the quantities of radioactive materials which were released from the Susquehanna Steam Electric Station during the period from January 1, 2000 to December 31, 2000. In addition, this report serves as a medium for notifying the US Nuclear Regulatory Commission staff of changes to the SSES Offsite Dose Calculation Manual (ODCM) and Solid Radioactive Waste Process Control Program (PCP) and documentation of any exceptions to the SSES effluent monitoring program which must be reported per Technical Requirements. A section containing corrections to a previously reported dose is also included.

Airborne and waterborne radioactive effluent releases to the environment during the report period were sampled and analyzed in accordance with the Technical Requirements. All radioactive effluent releases were within the concentration and release limits specified in the Technical Requirements. Calculations and terms utilized in this report are those outlined in the SSES ODCM.

Section 1 contains supplemental information pertaining to effluents from the Susquehanna plant. Included are regulatory limits (Table 1-1), sampling and analysis methods, and characterization of the number and duration of batch and abnormal releases, if any.

Section 2 contains effluent and waste disposal data for the report period. Table 2-1 contains a summation of all airborne releases, grouped into the radionuclide categories of gases, particulates, iodines, and tritium. Average release rates are presented and compared to the applicable limits. Table 2-2 presents the activity totals of specific radionuclides in airborne effluents.

Waterborne effluents are summarized in Table 2-3. Average diluted concentrations are presented and compared to the applicable limits. Table 2-4 presents the release quantities of specific radionuclides in waterborne effluents over the report period. Figures present the Susquehanna River Monthly Average Flow Rates for 2000 and the SSES Monthly Liquid Radwaste Discharge Totals for 2000.

Table 2-5 contains estimates of the errors associated with the measurements involved in quantifying effluents. Sampling errors, counting errors, and errors associated with determining effluent flow rates and volumes all contribute to the total error of effluent measurements. Error estimates are presented for each category of radionuclide detected in airborne and waterborne effluents and solid wastes during the report period.

Tables present a characterization of the solid radioactive waste shipped offsite during the report period. Included are the volumes and curie contents associated with each type of solid waste. An estimate of major nuclide composition is presented for each waste type, as well as the number of waste shipments from the site, how they were transported, and their final destination.

Section 3 presents meteorological data for 2000 including data recovery, joint frequency distribution of wind speed and direction, stability class distribution, and atmospheric dispersion estimates for selected locations.

Section 4 of this report contains an assessment of the calculated doses attributed to the reported radiological effluents for the calendar year. The LADTAP II code was used for calculation of doses from waterborne effluents. Site-specific parameters used in the calculations for the Danville receiver are shown in Table 4-1. The GASPARE code was used for calculation of doses from airborne effluents. The calculated doses and direct radiation estimates can be used to estimate the doses to maximally exposed members of the public. Table 4-2 summarizes maximum calculated doses and dose commitments to members of the public from airborne and waterborne effluents and direct radiation. Table 4-3 presents calculated collective doses to members of the public within the Riverlands/Information Center Complex. Table 4-4 summarizes the calculated doses for residences and other occupied areas within the SSES site boundary and nearest dairy.

Section 5 of this report documents changes to the Offsite Dose Calculation Manual and the Solid Radioactive Waste Process Control Program.

Section 6 presents a listing of cases (if any) in which airborne or waterborne effluent monitoring instrumentation was declared inoperable and was not restored to operability within the time period specified in Technical Requirements 3.11.1.1 or 3.11.2.1 Action Statements.

Section 7 contains corrections (if any) to doses reported in previous Semiannual or Annual Effluent and Waste Disposal Reports.

Section 8 contains information on effluent and offsite dose from the systems classified as insignificant effluent pathways

FIGURE 1-1

SSES AIRBORNE EFFLUENT RELEASE POINTS

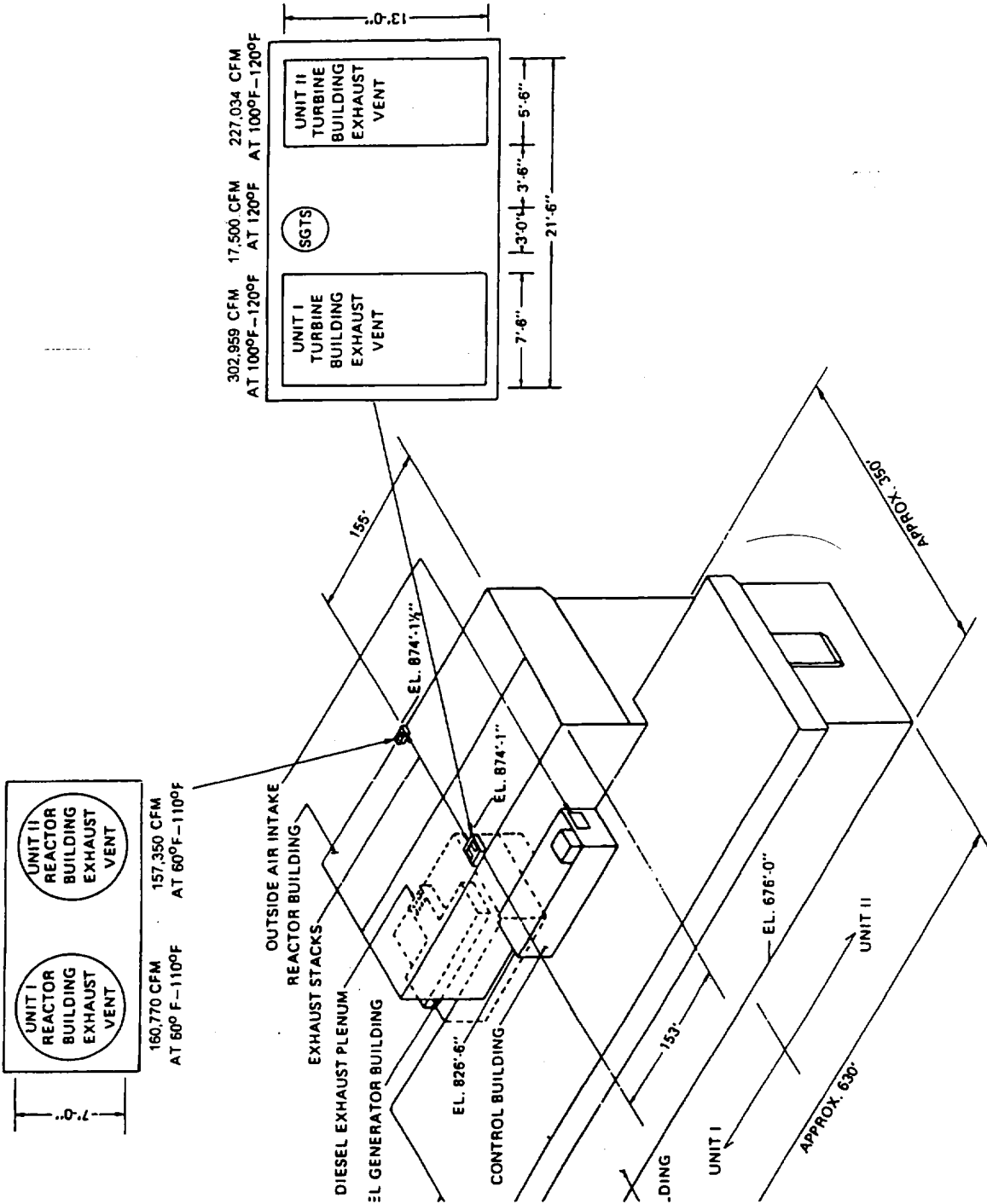
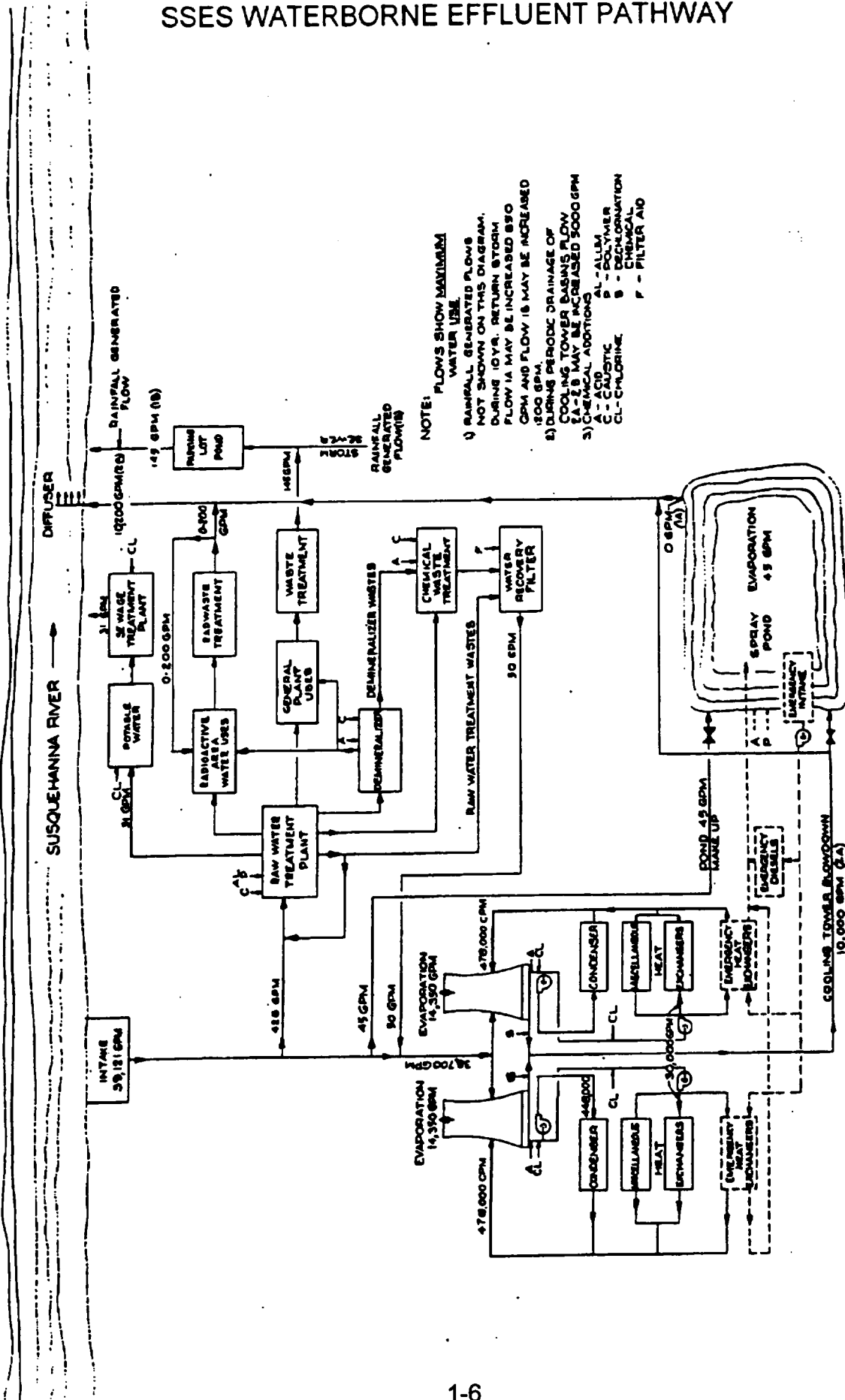

FIGURE 1-2
SSES WATERBORNE EFFLUENT PATHWAY



SUPPLEMENTAL INFORMATION

1. Regulatory Limits

Technical Requirements 3.11.1 and 3.11.2 outline requirements for release of radioactive liquid and gaseous effluents, respectively. Concentration of radioactive materials released in liquid effluents and dose or dose commitment resultant thereof are limited in unrestricted areas. Dose and dose rate due to radioactive materials released in gaseous effluents are limited in areas at or beyond the site boundary. Technical Requirement limits are listed in Table 1-1.

2. Maximum Permissible Concentrations in Waterborne Effluents

The concentration of radioactive material released in liquid effluents to unrestricted areas is limited to 10 times the concentrations specified in 10 CFR Part 20 Appendix B Table 2, Column 2, for radionuclides other than dissolved or entrained noble gases.

For dissolved or entrained noble gases, the concentration is limited to $2.0E-04$ $\mu\text{Ci/ml}$ total activity (TRO 3.11.1.1).

3. Average Energy of Fission and Activation Gas

Noble gas was not detected in gaseous effluent from either unit (January – December 2000).

4. Measurements and Approximations of Total Radioactivity

Analyses of specific radionuclides in effluent samples are used to evaluate the radioactive composition and concentration of effluents.

5. Methods of Quantifying Effluents

- a. **Fission and Activation Gases:** Gas samples are routinely collected monthly and analyzed with a high resolution (Ge[Li] or HPGE) detector system which incorporates a data reduction program to determine radionuclide composition in terms of specific activity. Data tapes from the continuous vent monitors are used to determine the average concentration of noble gases. The high resolution (Ge[Li] or HPGE) isotopic scan is used to convert the continuous vent monitor activity to actual activity based on the determined nuclide mixture. The vent and sample flow rates are continuously monitored and the average flow rates for each vent are used to calculate the total activity released in a given time period. When the continuous monitors are out of service, manual grab samples are taken from each vent once each eight hours (once each four hours for the standby gas treatment vent).

- b. **Iodines:** Iodine is continuously collected on charcoal cartridges via an isokinetic sampling assembly in each vent. Filters are normally exchanged once per week and analyzed on a high resolution (Ge[Li] or HPGE) system. The daily average flow rates for the vents and sample pumps are averaged for the duration of the sampling period and a ratio of vent flow rate to sample flow rate is determined. The ratio is used to determine the total activity of each isotope released during the time period in question. When the continuous monitors are out of service, iodine is continuously collected on charcoal cartridges attached to air samplers which draw directly from the affected rooftop vent(s) or from alternate sampling ports available on the sample lines.
- c. **Particulates:** Particulates are continuously collected via an isokinetic sampling assembly in each vent. Filters are normally exchanged once per week and analyzed on a high resolution (Ge[Li] or HPGE) system. Flow rate corrections are performed as for iodines. When the continuous vent monitors are out of service, particulates are continuously collected directly from the affected rooftop vent(s) or from alternate sampling ports available on the sample lines.
- d. **Tritium:** Airborne tritium is collected monthly via bubbler sampler. The sample is collected for one hour at a flow rate of approximately 1000 cc/min. Tritium activity in the bubbler sample is determined by liquid scintillation counting. The liquid sample tritium concentration is converted to air concentration by volume proportion, then compared to the Technical Requirement Table (TRO) 3.11.2.1.-1 Lower Limit of Detection ($1 \text{ E-6 } \mu\text{Ci/cc}$).
- e. **Waterborne Effluents:** Each tank of liquid radwaste is sampled and analyzed for principal gamma emitters prior to release. Each sample tank is recirculated for a sufficient amount of time prior to sampling to ensure that a representative sample is obtained. Samples are analyzed on a high resolution (Ge[Li] or HPGE) system and release permits are generated based on the values obtained from the isotopic analysis and the most recent values for tritium, gross alpha, iron-55, and strontium-89 and -90. An aliquot based on release volume is saved and added to monthly and quarterly composite containers. The monthly tritium analysis is done in-house. The monthly liquid radwaste composite sample is also analyzed offsite for P-32. The quarterly composite is sent to a vendor laboratory for iron-55, strontium-89 and -90, and gross alpha analyses.

The concentration of each radionuclide in each batch is decay-corrected from the time of counting to the midpoint of the release period, and is then multiplied by the volume of the batch to determine the total quantity of each nuclide released in each batch. The isotopic totals for each are summed to determine the total source term for the report period.

TABLE 1-1

1. **TECHNICAL REQUIREMENT LIMITS**

A. **NOBLE GASES:**

1. ≤ 500 mrem/year - TOTAL BODY
 ≤ 3000 mrem/year - SKIN
 - dose rate limit at and beyond the site boundary
(TRO 3.11.2.1)
2. ≤ 5 mrad - AIR GAMMA
 ≤ 10 mrad - AIR BETA
 - quarterly air dose limits per reactor unit at and beyond the site boundary
(TRO 3.11.2.2a)
3. ≤ 10 mrad - AIR GAMMA
 ≤ 20 mrad - AIR BETA
 - annual air dose limits per reactor unit at and beyond the site boundary
(TRO 3.11.2.2.b)

B. **AIRBORNE I-131, I-133, TRITIUM, PARTICULATES WITH HALF-LIVES > 8 DAYS:**

1. ≤ 1500 mrem/year - ORGAN
(inhalation pathways only)
 - dose rate limit at and beyond the site boundary
(TRO 3.11.2.1.II.A)
2. ≤ 7.5 mrem - ORGAN
 - quarterly dose limit per reactor unit at and beyond the site boundary
(TRO 3.11.2.3.a)
3. ≤ 15 mrem - ORGAN
 - annual dose limit per reactor unit at and beyond the site boundary
(TRO 3.11.2.3.b)

C. LIQUID EFFLUENTS:

1. ≤ 1.5 mrem - TOTAL BODY
 ≤ 5.0 mrem ORGAN
- quarterly dose limits per SSES unit (TRO 3.11.1.2.a)
2. ≤ 3.0 mrem - TOTAL BODY
 ≤ 10.0 mrem - ORGAN
- annual dose limits per SSES unit (TRO 3.11.1.2.b)

D. AIRBORNE EFFLUENT: BASES FOR PERCENT OF APPLICABLE TECHNICAL REQUIREMENT LIMIT

Fission and Activation Gases

A derived release rate limit based on the Technical Requirement (TRO 3.11.2.1.I.A) limit of 500 mrem/yr was calculated from the expected mix of noble gas radionuclides presented in Table 4.4 of the SSES Final Environmental Statement (NUREG-0564). The limit is $8.51E+05$ $\mu\text{Ci}/\text{min}$ ($1.42E+04$ $\mu\text{Ci}/\text{sec}$).

Iodines

A derived release rate limit based on the Technical Requirement (TRO 3.11.2.1.II.A) limit of 1500 mrem/yr from I-131, I-133, tritium and particulates with half-lives greater than 8 days was calculated from the annual release quantity of I-131 provided in Table 4.4 of the SSES Final Environmental Statement (NUREG-0564). The limit is $1.04E+02$ $\mu\text{Ci}/\text{min}$ ($1.73E+00$ $\mu\text{Ci}/\text{sec}$).

Particulates

A derived release rate limit based on the Technical Requirement (TRO 3.11.2.1.II.A) limit of 1500 mrem/yr from I-131, I-133, tritium and particulates with half-lives greater than 8 days was calculated based on the expected mix of particulate radionuclides presented in Table 4.4 of the SSES Final Environmental Statement (NUREG-0564). The limit is $7.72E+02$ $\mu\text{Ci}/\text{min}$ ($1.29E+01$ $\mu\text{Ci}/\text{sec}$).

Tritium

A derived release rate was calculated based on the 10 CFR 20, Appendix B, Table 2, Column 1, Effluent Concentration Limit for tritium ($1.0E-07$ $\mu\text{Ci}/\text{cc}$) to unrestricted areas. A relative concentration of $4.1E-05$ sec/m^3 was assumed. The limit is $1.46E+05$ $\mu\text{Ci}/\text{min}$ ($2.44E+03$ $\mu\text{Ci}/\text{sec}$).

E. WATERBORNE EFFLUENT: BASES FOR PERCENT OF APPLICABLE TECHNICAL REQUIREMENT LIMIT

Fission and Activation Products

Concentrations of fission and activation products in liquid effluent from radwaste effluent are determined for each batch prior to release. Each isotope concentration is compared to 10CFR20 Appendix B, Table 2, Column 2 Effluent Concentration Limits such that, with dilution, the sum of isotope concentrations divided by Effluent Concentrations must be <10. No Technical Requirement limit for the total concentration of fission and activation products in liquid effluents is applicable for this category.

Tritium

Liquid effluent quarterly tritium concentrations are compared to the 10 CFR 20 Appendix B, Table 2, Column 2, Effluent Concentration limit of $1.0E-03$ $\mu\text{Ci/ml}$ to unrestricted areas.

Dissolved and Entrained Gases

Liquid effluent quarterly concentration totals for dissolved and entrained gases are compared to the limiting value for a noble gas of $2.0E-04$ $\mu\text{Ci/ml}$.

SECTION 2
EFFLUENT AND WASTE DISPOSAL DATA

Airborne Effluents

Summaries of the radionuclide total curie activities and average release rates are included in Tables 2-1 and 2-2.

1. Number of Batch Releases:	0
2. Total Time Period for Batch Release:	NA
3. Maximum Time Period for a Batch Release:	NA
4. Average Time Period for a Batch Release:	NA
5. Minimum Time Period for a Batch Release:	NA

Abnormal Releases

1. Number of Releases	0
2. Total Activity Released	NA

If a radionuclide was not detected, zero activity was used for that isotope in dose calculations. A zero activity indicates that no activity was positively detected in any sample when samples were analyzed with techniques which achieved the required Lower Limits of Detection (LLD) as specified in the SSES Technical Requirement (TRO) Table 3.11.2.1-1, Radioactive Gaseous Effluent Sampling and Analysis Program. In all cases, these LLDs were less than the levels required by Technical Requirements. The following are typical LLDs.

<u>Radionuclide</u>	<u>LLD (µCi/cc)</u>
Kr-87	4.6 E-08
Kr-88	5.3 E-08
Xe-133	5.4 E-08
Xe-133m	1.3 E-07
Xe-135	1.5 E-08
Xe-135m	5.0E-08
Xe-138	1.2 E-07
Mn-54	2.9 E-14
Fe-59	2.8 E-14
Co-58	1.8 E-14
Co-60	3.8 E-14
Zn-65	4.4 E-14
Mo-99	3.3 E-13
Cs-134	2.4 E-14

<u>Radionuclide</u>	<u>LLD (μCi/cc)</u>
Cs-137	2.1 E-14
Ce-141	1.5 E-14
Ce-144	7.0 E-14
I-131	4.4 E-14
Sr-89	2.0 E-15
Sr-90	3.0 E-16
H-3	2.6 E-08
Gross Alpha	5.0 E-16

TABLE 2-1

**ANNUAL EFFLUENT AND WASTE DISPOSAL REPORT (2000)
AIRBORNE EFFLUENT - SUMMATION OF ALL RELEASES**

A. Fission and Activation Gas	Unit	First Quarter	Second Quarter	Third Quarter	Fourth Quarter
Total Release	Ci	0	0	0	0
Average Release Rate for Period	μCi/sec	0	0	0	0
Percent of Applicable Limit	%	0	0	0	0

B. Iodines⁽¹⁾

Total I-131	Ci	3.36E-6	0	0	0
Average Release Rate for Period	μCi/sec	4.27E-7	0	0	0
Percent of Applicable Limit	%	2.5E-5	0	0	0

C. Particulate⁽¹⁾

Particulate with Half-Lives >8 Days	Ci	1.30E-4	8.34E-4	1.16E-3	1.10E-3
Average Release Rate for Period	μCi/sec	1.66E-5	1.06E-4	1.46E-4	1.41E-4
Percent of Applicable Limit	%	1.3E-4	8.2E-4	1.1E-3	1.1E-3
Gross Alpha Radioactivity	Ci	2.72E-7	2.43E-7	0	0

D. Tritium

Total Release	Ci	2.27E+1	2.24E+1	2.24E+1	2.77E+1
Average Release Rate for Period	μCi/sec	2.89E+0	2.85E+0	2.82E+0	3.48E+0
Percent of Applicable Limit	%	1.2E-1	1.2E-1	1.2E-1	1.4E-1

⁽¹⁾Values >LLD include individual Airborne Monitor Line Loss Correction Factors from ODCM-QA-003 §6.4.1.

TABLE 2-2

ANNUAL EFFLUENT AND WASTE DISPOSAL REPORT (2000)
 AIRBORNE EFFLUENT
UNIT 1

Nuclides Released	Unit	Releases in Continuous Mode			
		First Quarter	Second Quarter	Third Quarter	Fourth Quarter
A. Fission and Activation Gases					
Total for Period	Ci	0	0	0	0
B. Iodines					
I-131	Ci	3.36E-6	0	0	0
Total for Period	Ci	3.36E-6	0	0	0
C. Particulate					
Cr-51	Ci	3.18E-5	2.38E-4	7.48E-4	3.88E-4
Mn-54	Ci	6.16E-5	2.02E-4	1.08E-5	5.08E-6
Co-60	Ci	8.19E-6	6.96E-5	2.20E-5	9.68E-5
As-76	Ci	0	0	0	3.27E-4
Ag-110m	Ci				
Nb-95	Ci				
Total for Period	Ci	1.02E-4	5.10E-4	7.81E-4	8.17E-4
D. Tritium					
Total for Period	Ci	1.12E+1	1.21E+1	1.36E+1	1.51E+1
D. Gross Alpha					
Total for Period	Ci	2.72E-7	2.43E-7	0	0

TABLE 2-2
(continued)
ANNUAL EFFLUENT AND WASTE DISPOSAL REPORT (2000)
AIRBORNE EFFLUENT
UNIT 2

Nuclides Released	Unit	Releases in Continuous Mode			
		First Quarter	Second Quarter	Third Quarter	Fourth Quarter
A. Fission and Activation Gases					
Total for Period	Ci	0	0	0	0
B. Iodines					
Total for Period	Ci	0	0	0	0
C. Particulate					
Cr-51	Ci			2.75E-4	
Mn-54	Ci	2.03E-5	9.21E-5	5.32E-5	2.13E-5
Co-60	Ci	7.59E-6		2.80E-5	1.74E-6
Sr-90	Ci	1.15E-6			
As-76	Ci				2.62E-4
Ag-110m	Ci		5.69E-6	1.85E-5	1.91E-5
Nb-95	Ci		2.24E-4		
Total for Period	Ci	2.90E-5	3.22E-4	3.75E-4	3.04E-4
D. Tritium					
Total for Period	Ci	1.14E+1	1.02E+1	8.66E+0	1.25E+1
D. Gross Alpha					
Total for Period	Ci	0	0	0	0

TABLE 2-2
(continued)
ANNUAL EFFLUENT AND WASTE DISPOSAL REPORT (2000)
AIRBORNE EFFLUENT
SGTS

Nuclides Released	Unit	Releases in Continuous Mode			
		First Quarter	Second Quarter	Third Quarter	Fourth Quarter
A. Fission and Activation Gases					
Total for Period	Ci	0	0	0	0
B. Iodines					
Total for Period	Ci	0	0	0	0
C. Particulate					
Mn-54	Ci		2.67E-6	1.72E-5	0
Co-60	Ci				1.08E-7
Total for Period	Ci	0	2.67E-6	1.72E-5	1.08E-7
D. Tritium					
Total for Period	Ci	4.63E-2	1.03E-1	1.84E-1	4.50E-2
D. Gross Alpha					
Total for Period	Ci	0	0	0	0

Waterborne Effluents

Summaries of the radionuclide total curie activities, average diluted concentrations, and percent of applicable Technical Requirement limits are included in Tables 2-3 and 2-4.

	<u>Batch Releases*</u>	<u>Qtr. 1</u>	<u>Qtr. 2</u>	<u>Qtr. 3</u>	<u>Qtr. 4</u>
1.	Number of Batch Releases	8	43	32	9
2.	Total Time Period for a Batch Release	5.13E+2	6.02E+3	5.91E+3	1.47E+3
3.	Maximum Time Period for a Batch Release	7.90E+1	2.94E+2	2.90E+2	2.75E+2
4.	Average Time Period for a Batch Release	6.41E+1	1.40E+2	1.85E+2	1.63E+2
5.	Minimum Time Period for a Batch Release	2.50E+1	2.70E+1	3.00E+1	2.80E+1
6.	Average Cooling Tower Blowdown Flow Rate During Periods of Release	7.07E+3	8.89E+3	9.44E+3	8.71E+3
7.	Susquehanna River Flow Rate	11.1E+6	14.6E+6	2.2E+6	3.8E+6

*Units of time and flow are expressed in minutes and gallons per minute (gpm), respectively.

	<u>Abnormal Releases</u>				
1.	Number of Releases	0	0	0	0
2.	Volume Released	N/A	N/A	N/A	N/A
3.	Total Activity Released	N/A	N/A	N/A	N/A

If a radionuclide was not detected, zero activity was used for that isotope in dose calculations. A zero activity indicates that no activity was positively detected in any sample when samples were analyzed with techniques which achieved the required Lower Limits of Detection (LLD) as specified in the SSES Technical Requirement 4.11.1.1.1-1, Radioactive Liquid Waste Sampling and Analysis Program. In all cases, these LLDs were less than the levels required by Technical Requirements. The following are typical LLDs.

<u>Radionuclide</u>	<u>LLD (µCi/ml)</u>
Mn-54	4.5 E-08
Fe-59	5.0 E-08
Co-58	2.4 E-08
Co-60	5.4 E-08
Zn-65	4.9 E-08
Mo-99	1.7 E-07
I-131	2.0 E-08
Cs-134	2.2 E-08

<u>Radionuclide</u>	<u>LLD (μCi/ml)</u>
Cs-137	2.6 E-08
Ce-141	3.2 E-08
Ce-144	1.3 E-07
Sr-89	4.0 E-08
Sr-90	4.0 E-09
Fe-55	1.0 E-06
H-3	4.6 E-06
Gross Alpha	3.0 E-08

TABLE 2-3

**ANNUAL EFFLUENT AND WASTE DISPOSAL REPORT (2000)
WATERBORNE EFFLUENT - SUMMATION OF ALL RELEASES**

A. Fission and Activation Products	Unit	First Quarter	Second Quarter	Third Quarter	Fourth Quarter
1. Total Release (not including Tritium, Gases, Alpha)	Ci	6.58E-3	2.19E-2	3.29E-3	5.18E-3
2. Average Diluted Concentration During Period	µCi/ml	4.81E-5	1.20E-5	1.77E-6	1.16E-5
B. Tritium					
1. Total Release	Ci	4.43E-1	1.76E+1	2.27E+1	6.62E+0
2. Average Diluted Concentration During Period	µCi/ml	3.37E-5	9.13E-5	1.09E-4	1.31E-4
3. Percent of Applicable Limit (1.0E-3)	%	3.37E+0	9.13E+0	1.09E+1	1.31E+1
C. Dissolved and Entrained Gases					
1. Total Release	Ci	0	3.85E-5	5.05E-5	3.62E-6
2. Average Diluted Concentration During Period	µCi/ml	0	1.99E-10	2.42E-10	7.19E-11
3. Percent of Applicable Limit (2.0E-4)	%	0	9.97E-5	1.21E-4	3.60E-5
D. Gross Alpha Radioactivity					
1. Total Release	Ci	0	0	0	0
E. Volume of Waste Released (Prior to Dilution)					
	Gallons	3.62E+4	4.80E+5	4.92E+5	1.18E+5
	Liters	1.37E+5	1.82E+6	1.86E+6	4.47E+5
F. Volume of Dilution Water Used During Period of Release					
	Gallons	3.44E+6	5.03E+7	5.47E+7	1.32E+7
	Liters	1.30E+7	1.91E+8	2.07E+8	4.99E+7
G. Volume of Dilution Water Used Over Entire Period					
	Gallons	7.53E+8	1.12E+9	1.33E+9	9.77E+8
	Liters	2.85E+9	4.23E+9	5.02E+9	3.70E+9

TABLE 2-4

ANNUAL EFFLUENT AND WASTE DISPOSAL REPORT (2000)
WATERBORNE EFFLUENT

Nuclides Released	Unit	Releases in Batch Mode			
		First Quarter	Second Quarter	Third Quarter	Fourth Quarter
A. Fission and Activation Products					
F-18	Ci	0	1.91E-7	0	0
Cr-51	Ci	0	3.43E-3	1.23E-3	1.71E-3
Mn-54	Ci	1.17E-4	6.76E-3	1.11E-3	1.69E-3
Fe-55	Ci	6.30E-3	2.18E-3	1.84E-4	7.20E-4
Fe-59	Ci	0	1.77E-5	4.20E-5	3.60E-6
Co-58	Ci	4.75E-6	1.13E-3	3.91E-5	1.27E-4
Co-60	Ci	1.57E-4	8.20E-3	6.40E-4	8.83E-4
Zn-65	Ci	0	1.23E-4	1.27E-5	4.35E-5
Sr-90	Ci	0	0	2.63E-5	0
Nb-95	Ci	0	0	0	1.30E-6
Ag-110m	Ci	5.42E-6	1.16E-5	1.90E-6	0
Total for Period	Ci	6.58E-3	2.19E-2	3.29E-3	5.18E-3
B Tritium					
Total for Period	Ci	4.43E-1	1.76E+1	2.27E+1	6.62E+0
C. Dissolved and Entrained Gases					
Xe-133m	Ci	0	0	2.48E-6	0
Xe-133	Ci	0	3.15E-5	2.98E-5	3.62E-6
Xe-135	Ci	0	6.95E-6	1.82E-5	0
Total for Period	Ci	0	3.85E-5	5.05E-5	3.62E-6

Figure 2-1
Susquehanna River Monthly Average Flow Rates
Data Period: 2000

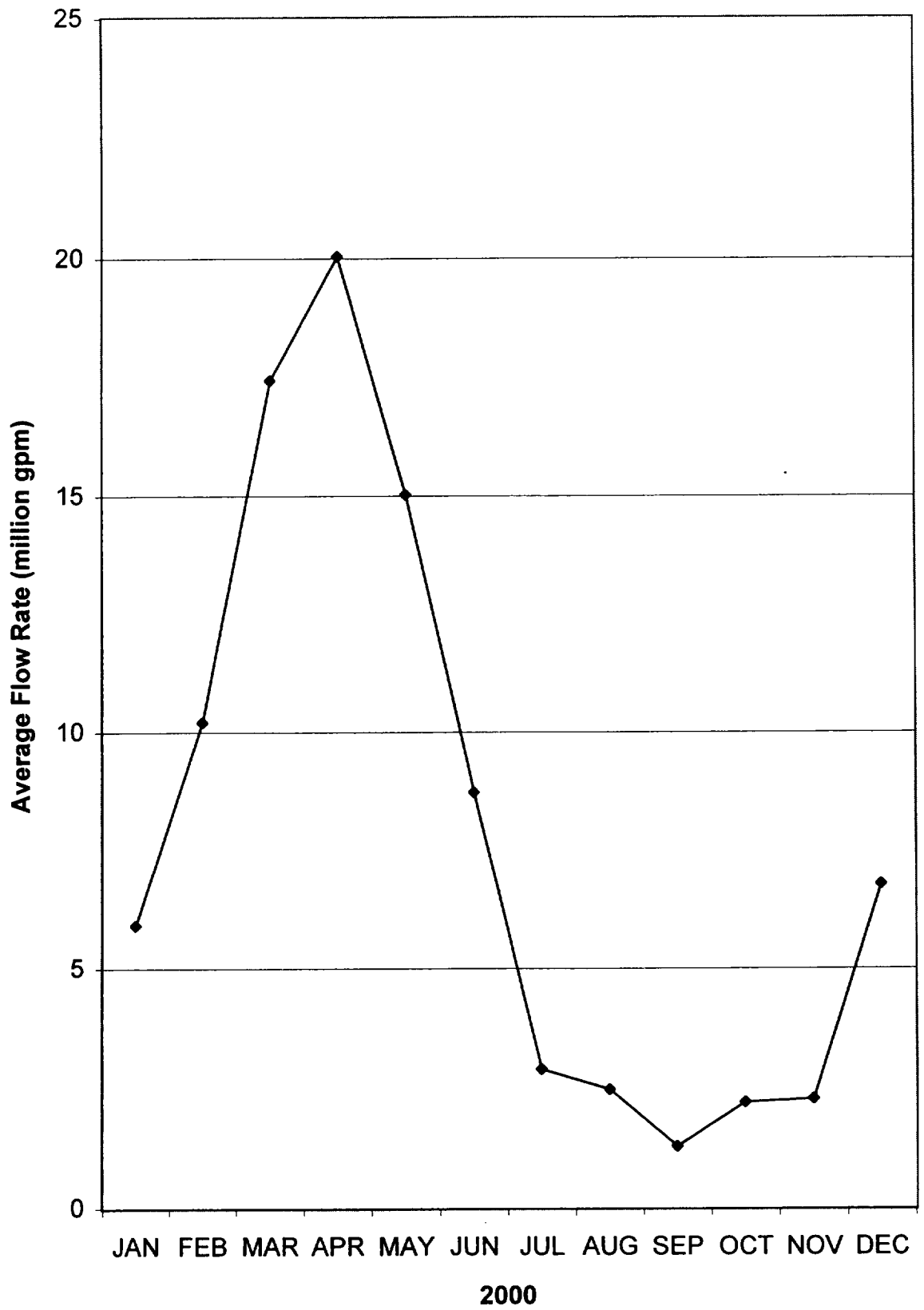

Figure 2-2
SSES Monthly Liquid Radwaste Discharge Totals
Data Period: 2000

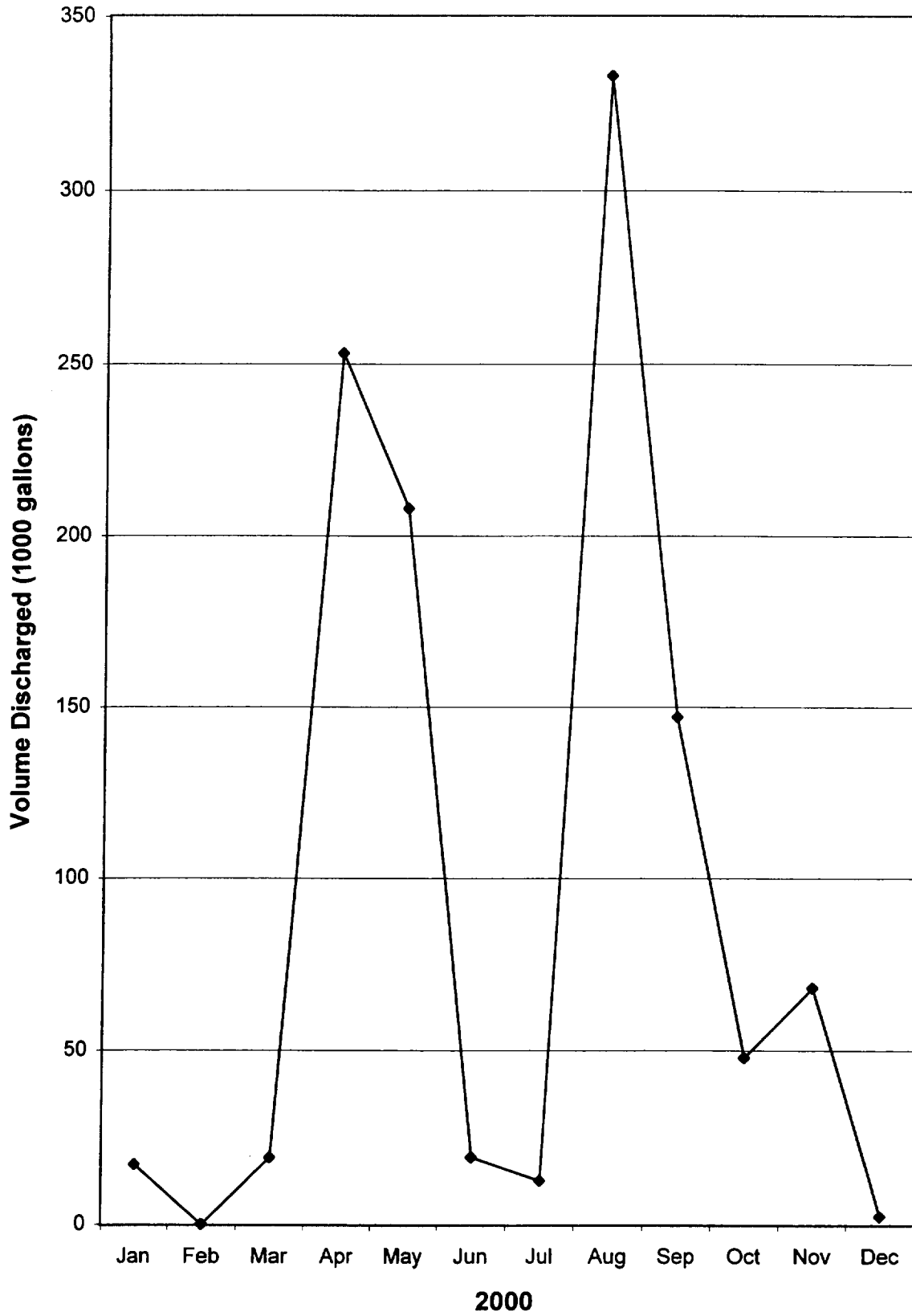

TABLE 2-5

**ANNUAL EFFLUENT AND WASTE DISPOSAL REPORT
ESTIMATED TOTAL ERRORS ASSOCIATED WITH
EFFLUENTS MEASUREMENTS
DATA PERIOD: JANUARY 1, 2000 - DECEMBER 31, 2000**

<u>MEASUREMENT</u>	<u>ESTIMATED TOTAL ERROR</u>
1. Airborne Effluents	
a. Fission and Activation Gases	15.9%
b. I-131	13.3%
c. Particulates (incl. Gross Alpha)	15.8%
d. Tritium	13.6%
2. Waterborne Effluents	
a. Fission and Activation Products	5.0%
b. Tritium	3.3%
c. Dissolved and Entrained Gases	8.4%
d. Gross Alpha Activity	6.0%
e. Volume of Waste Released (Prior to Dilution)	5.0%
f. Volume of Dilution Water Used During Period	15.0%
3. Solid Wastes	
a. Condensate Demineralizer/Radwaste Demineralizer (Dewatered - Steel Liner)	15%
b. Condensate Demineralizer/Radwaste Demineralizer (Solidification - Steel Liner)	15%
c. Liquid Radwaste Filter Media (Dewatered - HIC)	15%
d. RWCU Filter Media (Dewatered - HIC)	25%
e. Condensate Filters (Dewatered - Steel Liner)	15%
f. Processed DAW (Strong Tight Container)	25%
g. Cartridge Filters (Dewatered - HIC)	15%

	<u>MEASUREMENT</u>	<u>ESTIMATED TOTAL ERROR</u>
3.	Solid Wastes (cont.)	
h.	Liquid Oily/Waste (Blending/Co-Generation-Steel Liner)	25%
i.	Bead Resin (Pyrolysis – HIC)	15%
j.	Condensate Filter Backwash (Dewatered - HIC)	15%
k.	Irradiated Components (Dewatered – Steel Liner)	15%
l.	Irradiated Components (Dewatered – HIC)	15%
m.	Non-Processed DAW (HIC)	25%

SUSQUEHANNA STEAM ELECTRIC STATION
RADIOACTIVE WASTE REPORT
ANNUAL EFFLUENT AND WASTE DISPOSAL REPORT
SOLID RADIOACTIVE WASTE

DATA PERIOD: JANUARY 1, 2000- DECEMBER 31, 2000

PREPARED BY:

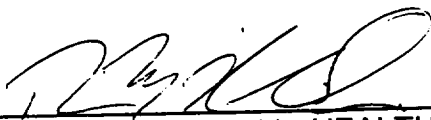

T. M. Kalinowski - HEALTH PHYSICIST

APPROVED BY:

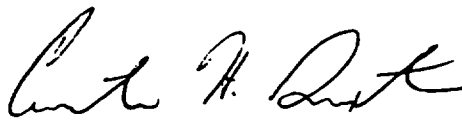

C. H. Saxton - EFFLUENTS MANAGEMENT SUPV

REPORT NOTES

1. All activities reported in millicuries (mCi) unless otherwise noted.
2. Reported activities, as indicated with the (<) sign, are comprised in whole or part of MDL values.
3. NP indicates the nuclide was not present in the waste.
4. The volume and activity totals listed for each waste stream represent the total volume and activity of PPL waste sent for disposal during the reporting period. This includes both waste shipped directly to a disposal site from PPL Susquehanna and waste shipped via a processor.

TABLE 2-6

WASTE DISPOSITIONS

Data Period: January 1, 2000 - December 31, 2000

A. SOLID WASTE SHIPPED OFFSITE FOR BURIAL OR DISPOSAL

<u>Number of Shipments</u>	<u>Mode of Transportation</u>	<u>Destination</u>
22	Truck	Barnwell, SC

B. IRRADIATED FUEL SHIPMENTS

<u>Number of Shipments</u>	<u>Mode of Transportation</u>	<u>Destination</u>
None		

*The number of shipments listed in A include only the shipments from SSES to a disposal site. It does not include shipments made to or from volume reduction vendors.

TABLE 2-7

WASTE CLASS		A
SOURCE OF WASTE:		CONDENSATE DEMINERALIZER/ RADWASTE DEMINERALIZER
TYPE OF CONTAINER:		STEEL LINER
METHOD OF PROCESS:		DEWATERED
ISOTOPES	ACTIVITY (mCi)	% OF TOTAL
Ag-110m	6.600E+00	0.03%
Am-241	4.857E-02	0.00%
C-14	3.969E+02	1.93%
Ce 144	1.994E+01	0.10%
Cm-242	4.342E-02	0.00%
Cm-244	4.649E-02	0.00%
Co-58	1.803E+02	0.88%
Co-60	8.109E+03	39.38%
Cr-51	2.230E+02	1.08%
Cs-134	0.000E+00	0.00%
Cs-137	1.796E+01	0.09%
Fe-55	1.382E+02	0.67%
Fe-59	1.802E+02	0.88%
H-3	1.377E+02	0.67%
Hf-181	0.000E+00	0.00%
I-129	<1.725E-04	0.00%
I-131	0.000E+00	0.00%
I-133	0.000E+00	0.00%
La-140	0.000E+00	0.00%
Mn-54	1.053E+04	51.14%
Nb-95	4.100E+01	0.20%
Ni-59	3.358E+00	0.02%
Ni-63	1.552E+02	0.75%
Pu-238	6.695E-02	0.00%
Pu-239	4.123E-02	0.00%
Pu-241	9.821E+00	0.05%
Sb-124	9.220E+00	0.04%
Sr-89	0.000E+00	0.00%
Sr-90	1.280E-01	0.00%
Sr-92	2.200E-05	0.00%
Tc-99	7.893E+01	0.38%
Zn-65	3.430E+02	1.67%
Zr-95	9.300E+00	0.05%
TOTAL ACTIVITY (Ci)	20.591	100.00%
CONTAINER VOLUME	797.60 ft ³	22.59 m ³

TABLE 2-8

WASTE CLASS	A	
SOURCE OF WASTE:	CONDENSATE DEMINERALIZER/ RADWASTE DEMINERALIZER	
TYPE OF CONTAINER:	STEEL LINER	
METHOD OF PROCESS:	SOLIDIFICATION-Q-CEP	
ISOTOPE	ACTIVITY (mCi)	% OF TOTAL
Ag-110m	0.000E+00	0.00%
Am-241	3.031E-02	0.00%
Ba-140	0.000E+00	0.00%
C-14	NP	0.00%
Ce-141	0.000E+00	0.00%
Ce-144	1.531E+00	0.00%
Cm-242	5.017E-02	0.00%
Cm-243	0.000E+00	0.00%
Cm-244	3.002E-02	0.00%
Co-58	1.831E+03	3.71%
Co-60	2.481E+04	50.30%
Cr-51	0.000E+00	0.00%
Cs-134	0.000E+00	0.00%
Cs-137	1.167E-01	0.00%
Fe-55	1.491E+02	0.30%
Fe-59	0.000E+00	0.00%
H-3	NP	0.00%
Hf-181	0.000E+00	0.00%
I-129	0.000E+00	0.00%
I-131	0.000E+00	0.00%
I-133	0.000E+00	0.00%
La-140	0.000E+00	0.00%
Mn-54	2.176E+04	44.12%
Ni-59	7.829E+01	0.16%
Ni-63	2.347E+02	0.48%
Pu-238	3.647E-02	0.00%
Pu-239	3.657E-02	0.00%
Pu-241	3.686E+01	0.07%
Sb-124	0.000E+00	0.00%
Sr-90	1.970E-02	0.00%
Sr-92	0.000E+00	0.00%
Tc-99	2.652E+02	0.54%
Xe-133	0.000E+00	0.00%
Zn-65	1.525E+02	0.31%
Zr-95	0.000E+00	0.00%
TOTAL ACTIVITY (Ci)	49.321	100.00%
CONTAINER VOLUME	3.91 ft ³	0.11 m ³

TABLE 2-9

WASTE CLASS	A	
SOURCE OF WASTE:	LIQUID RADWASTE FILTER MEDIA	
TYPE OF CONTAINER:	HIC	
METHOD OF PROCESS:	DEWATERED	
ISOTOPES	ACTIVITY (mCi)	% OF TOTAL

Ag-110m	4.250E+01	0.06%
Am-241	4.770E-02	0.00%
C-14	2.444E+00	0.00%
Ce 144	4.020E+00	0.01%
Cm-242	4.460E-02	0.00%
Cm-244	4.770E-02	0.00%
Co-58	1.127E+03	1.51%
Co-60	1.917E+04	25.73%
Cr-51	1.720E+03	2.31%
Cs-134	0.000E+00	0.00%
Cs-137	5.960E+00	0.01%
Fe-55	5.780E+02	0.78%
Fe-59	2.696E+03	3.62%
H-3	3.850E+01	0.05%
I-129	<2.750E-04	0.00%
I-131	0.000E+00	0.00%
Mn-54	4.762E+04	63.91%
Nb-95	4.770E+01	0.06%
Ni-59	7.160E+01	0.10%
Ni-63	1.785E+02	0.24%
Ni-65	0.000E+00	0.00%
Pu-238	1.193E-02	0.00%
Pu-239	1.194E-02	0.00%
Pu-241	2.379E+00	0.00%
Sb-124	8.190E+01	0.11%
Sr-89	0.000E+00	0.00%
Sr-90	0.000E+00	0.00%
Sr-92	0.000E+00	0.00%
Tc-99	1.795E+02	0.24%
Zn-65	9.480E+02	1.27%
TOTAL ACTIVITY (Ci)	74.514	100.00%
CONTAINER VOLUME	264.80 ft ³	7.50 m ³

TABLE 2-10

WASTE CLASS	A	
SOURCE OF WASTE:	RWCU FILTER MEDIA	
TYPE OF CONTAINER:	HIC	
METHOD OF PROCESS:	DEWATERED	
ISOTOPES	ACTIVITY (mCi)	% OF TOTAL
Ag-110m	2.610E+03	0.21%
Am-241	1.246E-02	0.00%
C-14	7.480E+00	0.00%
Ce 144	5.080E+00	0.00%
Cm-242	5.270E-03	0.00%
Cm-244	1.221E-02	0.00%
Co-58	1.030E+04	0.81%
Co-60	6.220E+05	48.91%
Cr-51	0.000E+00	0.00%
Cs-134	0.000E+00	0.00%
Cs-137	2.170E+02	0.02%
Fe-55	1.226E+03	0.10%
Fe-59	0.000E+00	0.00%
H-3	4.830E+02	0.04%
I-129	<1.334E-03	0.00%
I-131	0.000E+00	0.00%
Mn-54	5.940E+05	46.71%
Nb-95	5.870E+03	0.46%
Ni-59	2.250E+02	0.02%
Ni-63	7.460E+02	0.06%
Pu-238	2.070E-02	0.00%
Pu-239	2.080E-02	0.00%
Pu-241	3.240E+00	0.00%
Sb-124	0.000E+00	0.00%
Sb-125	1.194E+04	0.94%
Sn-113	1.964E+03	0.15%
Sr-89	2.590E+00	0.00%
Sr-90	9.430E-01	0.00%
Tc-99	3.780E+02	0.03%
Zn-65	4.010E+03	0.32%
Zr-95	1.578E+04	1.24%
TOTAL ACTIVITY (Ci)	1271.768	100.00%
CONTAINER VOLUME	264.80 ft ³	7.50 m ³

TABLE 2-11

WASTE CLASS	A	
SOURCE OF WASTE:	CONDENSATE FILTERS	
TYPE OF CONTAINER:	STEEL LINER	
METHOD OF PROCESS:	DEWATERED	
ISOTOPES	ACTIVITY (mCi)	% OF TOTAL
-----	-----	-----
Ag-110m	4.240E+01	0.22%
Am-241	2.545E-01	0.00%
C-14	0.000E+00	0.00%
CE-141	2.369E+01	0.12%
Ce 144	1.005E+02	0.53%
Cm-242	2.498E-01	0.00%
Cm-244	2.544E-01	0.00%
Co-58	1.701E+02	0.89%
Co-60	4.690E+03	24.64%
Cr-51	1.328E+02	0.70%
Cs-134	0.000E+00	0.00%
Cs-137	1.016E+01	0.05%
Fe-55	5.075E+03	26.66%
Fe-59	1.087E+02	0.57%
H-3	6.975E+00	0.04%
I-129	2.190E+01	0.12%
I-131	0.000E+00	0.00%
Mn-54	7.865E+03	41.31%
Ni-63	0.000E+00	0.00%
Pu-238	2.545E-01	0.00%
Pu-239	2.545E-01	0.00%
Pu-241	4.585E+01	0.24%
Sb-124	0.000E+00	0.00%
Sr-89	0.000E+00	0.00%
Sr-90	0.000E+00	0.00%
Tc-99	0.000E+00	0.00%
Zn-65	7.435E+02	3.91%
TOTAL ACTIVITY (Ci)	19.038	100.00%
CONTAINER VOLUME	356.20 ft ³	10.09 m ³

TABLE 2-12

WASTE CLASS	A	
SOURCE OF WASTE:	PROCESSED DAW	
TYPE OF CONTAINER:	STRONG TIGHT CONTAINER	
METHOD OF PROCESS:	COMPACTION	
ISOTOPES	ACTIVITY (mCi)	% OF TOTAL
-----	-----	-----
Ag-110m	5.734E+01	0.29%
Am-241	2.610E-01	0.00%
Ba-133	2.776E-05	0.00%
C-14	<4.419E-02	0.00%
Cd-109	1.515E-04	0.00%
Ce-139	2.722E-07	0.00%
Ce-141	2.369E+01	0.12%
Ce 144	1.015E+02	0.50%
Cm-242	2.632E-01	0.00%
Cm-244	2.602E-01	0.00%
Co-57	3.019E-06	0.00%
Co-58	1.762E+02	0.88%
Co-60	4.995E+03	24.85%
Cr-51	1.448E+02	0.72%
Cs-134	4.728E-04	0.00%
Cs-137	1.142E+01	0.06%
Fe-55	5.182E+03	25.78%
Fe-59	1.626E+02	0.81%
H-3	7.937E+00	0.04%
Hg-203	2.263E-10	0.00%
I-129	<2.190E+01	0.00%
I-131	5.337E-19	0.00%
Mn-54	8.426E+03	41.92%
Nb-95	1.245E-01	0.00%
Ni-59	8.302E-01	0.00%
Ni-63	5.608E+00	0.03%
Pu-238	2.644E-01	0.00%
Pu-239	2.635E-01	0.00%
Pu-241	4.807E+01	0.24%
Ru-106	1.137E-01	0.00%
Sb-124	0.000E+00	0.00%
Sn-113	1.445E-07	0.00%
Sr-85	3.597E-12	0.00%
Sr-89	1.321E-02	0.00%
Sr-90	6.482E-02	0.00%
Tc-99	<1.272E-01	0.00%
Y-88	2.539E-07	0.00%
Zn-65	7.580E+02	3.77%
Zr-95	0.000E+00	0.00%
TOTAL ACTIVITY (Ci)	20.102	100.00%
CONTAINER VOLUME	1727.53 ft ³	48.92 m ³

TABLE 2-13

WASTE CLASS A
 SOURCE OF WASTE: CARTRIDGE FILTERS

TYPE OF CONTAINER: HIC

METHOD OF PROCESS: DEWATERED

ISOTOPES	ACTIVITY (mCi)	% OF TOTAL
Ag-110m	5.385E+01	0.21%
Am-241	3.563E-01	0.00%
Ba-133	0.000E+00	0.00%
C-14	<4.640E-02	0.00%
Cd-109	0.000E+00	0.00%
Ce-139	0.000E+00	0.00%
Ce-141	1.547E+01	0.06%
Ce 144	1.295E+02	0.51%
Cm-242	3.013E-01	0.00%
Cm-244	3.563E-01	0.00%
Co-57	0.000E+00	0.00%
Co-58	1.673E+02	0.66%
Co-60	6.519E+03	25.74%
Cr-51	9.383E+01	0.37%
Cs-134	0.000E+00	0.00%
Cs-137	1.432E+01	0.06%
Fe-55	6.989E+03	27.59%
Fe-59	8.684E+01	0.34%
H-3	3.151E+00	0.01%
Hg-203	0.000E+00	0.00%
I-129	3.070E+01	0.12%
I-131	0.000E+00	0.00%
Mn-54	1.022E+04	40.34%
Nb-95	0.000E+00	0.00%
Ni-59	0.000E+00	0.00%
Ni-63	0.000E+00	0.00%
Pu-238	3.563E-01	0.00%
Pu-239	3.563E-01	0.00%
Pu-241	6.381E+01	0.25%
Ru-106	0.000E+00	0.00%
Sb-124	0.000E+00	0.00%
Sn-113	0.000E+00	0.00%
Sr-85	0.000E+00	0.00%
Sr-89	0.000E+00	0.00%
Sr-90	0.000E+00	0.00%
Tc-99	<2.326E-02	0.00%
Y-88	0.000E+00	0.00%
Zn-65	9.429E+02	3.72%
Zr-95	0.000E+00	0.00%
TOTAL ACTIVITY (Ci)	25.330	100.00%
CONTAINER VOLUME	124.50 ft ³	3.53 m ³

TABLE 2-14

WASTE CLASS		A
SOURCE OF WASTE:		LIQUID OILY WASTE (PETROLEUM BASED MATERIAL)
TYPE OF CONTAINER:		STEEL LINER
METHOD OF PROCESS:		FUEL BLENDING FOR CO-GENERATION
ISOTOPES	ACTIVITY (mCi)	% OF TOTAL
Ag-110m	0.000E+00	0.00%
Am-241	5.470E-07	0.00%
C-14	<2.160E-10	0.00%
Cd-109	0.000E+00	0.00%
Ce 144	1.970E-05	0.00%
Cm-242	6.170E-07	0.00%
Cm-244	3.940E-07	0.00%
Co-58	0.000E+00	0.00%
Co-60	6.550E-02	2.89%
Cr-51	0.000E+00	0.00%
Cs-134	0.000E+00	0.00%
Cs-137	3.150E-05	0.00%
Fe-55	2.510E-02	1.11%
Fe-59	0.000E+00	0.00%
H-3	2.120E+00	93.54%
I-129	<5.790E-09	0.00%
I-131	0.000E+00	0.00%
Mn-54	5.380E-02	2.37%
Ni-59	2.910E-04	0.01%
Ni-63	1.340E-03	0.06%
Pu-238	6.680E-07	0.00%
Pu-239	6.740E-07	0.00%
Pu-241	1.920E-04	0.01%
Ra-226	0.000E+00	0.00%
Sb-124	0.000E+00	0.00%
Sr-89	0.000E+00	0.00%
Sr-90	1.530E-05	0.00%
Tc-99	5.060E-05	0.00%
Zn-65	0.000E+00	0.00%
TOTAL ACTIVITY (Ci)	0.002	100.00%
CONTAINER VOLUME	0.00 ft ³	0.00 m ³

TABLE 2-15

WASTE CLASS A

SOURCE OF WASTE: BEAD RESIN

TYPE OF CONTAINER: HIC

METHOD OF PROCESS: PYROLYSIS

ISOTOPES	ACTIVITY (mCi)	% OF TOTAL
Ag-110m	2.595E+01	0.16%
Am-241	1.221E-01	0.00%
C-14	5.682E+02	3.43%
Ce 144	2.590E+01	0.16%
Cm-242	1.445E-01	0.00%
Cm-244	1.163E-01	0.00%
Co-58	4.782E+02	2.89%
Co-60	9.396E+03	56.75%
Cr-51	1.263E+02	0.76%
Cs-134	0.000E+00	0.00%
Cs-137	2.642E+01	0.16%
Fe-55	1.953E+02	1.18%
Fe-59	4.449E+01	0.27%
H-3	2.981E+02	1.80%
Hf-181	5.868E-13	0.00%
I-129	0.000E+00	0.00%
I-131	5.063E-02	0.00%
I-133	0.000E+00	0.00%
La-140	1.584E-06	0.00%
Mn-54	4.906E+03	29.63%
Nb-95	0.000E+00	0.00%
Ni-59	2.826E+00	0.02%
Ni-63	1.274E+02	0.77%
Pu-238	1.388E-01	0.00%
Pu-239	1.294E-01	0.00%
Pu-241	3.044E+01	0.18%
Sb-124	4.403E-11	0.00%
Sr-89	0.000E+00	0.00%
Sr-90	4.270E-01	0.00%
Sr-92	5.316E-175	0.00%
Tc-99	3.664E+01	0.22%
Zn-65	2.667E+02	1.61%
Zr-95	0.000E+00	0.00%
TOTAL ACTIVITY (Ci)	16.556	100.00%
CONTAINER VOLUME	203.66 ft ³	5.77 m ³

TABLE 2-16

WASTE CLASS	A	
SOURCE OF WASTE:	CONDENSATE FILTER BACKWASH	
TYPE OF CONTAINER:	HIC	
METHOD OF PROCESS:	DEWATERED	
ISOTOPES	ACTIVITY (mCi)	% OF TOTAL

Ag-110m	0.000E+00	0.00%
Am-241	8.630E-03	0.00%
C-14	1.552E+02	0.18%
CE-141	0.000E+00	0.00%
Ce 144	3.088E+00	0.00%
Cm-242	7.130E-03	0.00%
Cm-244	8.580E-03	0.00%
Co-58	7.982E+02	0.94%
Co-60	3.162E+04	37.10%
Cr-51	1.220E+03	1.43%
Cs-134	0.000E+00	0.00%
Cs-137	4.470E+01	0.05%
Fe-55	1.418E+03	1.66%
Fe-59	1.408E+03	1.65%
H-3	3.027E+01	0.04%
I-129	<2.204E-04	0.00%
I-131	0.000E+00	0.00%
Mn-54	4.720E+04	55.39%
Nb-95	6.050E+01	0.07%
Ni-59	1.552E+01	0.02%
Ni-63	2.670E+02	0.31%
Pu-238	8.630E-03	0.00%
Pu-239	8.630E-03	0.00%
Pu-241	1.199E+01	0.01%
Sb-124	3.620E+01	0.04%
Sr-89	1.763E-01	0.00%
Sr-90	1.031E+00	0.00%
Tc-99	7.420E+01	0.09%
Zn-65	8.550E+02	1.00%
TOTAL ACTIVITY (Ci)	85.219	100.00%
CONTAINER VOLUME	397.20 ft ³	11.25 m ³

TABLE 2-17

WASTE CLASS	B	
SOURCE OF WASTE:	IRRADIATED COMPONENTS	
TYPE OF CONTAINER:	STEEL LINER	
METHOD OF PROCESS:	DEWATERED	
ISOTOPES	ACTIVITY (mCi)	% OF TOTAL

Ag-110m	0.000E+00	0.00%
Am-241	0.000E+00	0.00%
Am-243	0.000E+00	0.00%
C-14	3.080E+01	0.01%
Ce 144	0.000E+00	0.00%
Cm-242	0.000E+00	0.00%
Cm-243	0.000E+00	0.00%
Cm-244	0.000E+00	0.00%
Co-58	6.070E+00	0.00%
Co-60	2.280E+05	54.89%
Cr-51	1.710E+01	0.00%
Cs-134	0.000E+00	0.00%
Cs-137	0.000E+00	0.00%
Fe-55	1.630E+05	39.24%
Fe-59	0.000E+00	0.00%
H-3	NP	0.00%
I-129	NP	0.00%
I-131	0.000E+00	0.00%
Mn-54	1.570E+03	0.38%
Nb-94	5.770E-01	0.00%
Ni-59	1.250E+02	0.03%
Ni-63	2.260E+04	5.44%
Np-237	0.000E+00	0.00%
Pu-238	0.000E+00	0.00%
Pu-239	0.000E+00	0.00%
Pu-241	0.000E+00	0.00%
Pu-242	0.000E+00	0.00%
Sb-124	0.000E+00	0.00%
Sr-89	0.000E+00	0.00%
Sr-90	0.000E+00	0.00%
Tc-99	1.250E-01	0.00%
U-235	0.000E+00	0.00%
Zn-65	0.000E+00	0.00%
Zr-95	0.000E+00	0.00%
TOTAL ACTIVITY (Ci)	415.350	100.00%
CONTAINER VOLUME	125.20 ft ³	3.55 m ³

TABLE 2-18

WASTE CLASS	C	
SOURCE OF WASTE:	IRRADIATED COMPONENTS	
TYPE OF CONTAINER:	HIC	
METHOD OF PROCESS:	DEWATERED	
ISOTOPES	ACTIVITY (mCi)	% OF TOTAL
-----	-----	-----
Ag-110m	0.000E+00	0.00%
Am-241	4.930E-06	0.00%
Am-243	1.200E-07	0.00%
C-14	1.400E+00	0.01%
Ce 144	0.000E+00	0.00%
Cm-242	7.040E-04	0.00%
Cm-243	8.330E-06	0.00%
Cm-244	0.000E+00	0.00%
Co-58	5.670E+00	0.03%
Co-60	1.070E+04	53.20%
Cr-51	1.270E+01	0.06%
Cs-134	0.000E+00	0.00%
Cs-137	0.000E+00	0.00%
Fe-55	8.180E+03	40.67%
Fe-59	0.000E+00	0.00%
H-3	0.000E+00	0.00%
I-129	0.000E+00	0.00%
I-131	0.000E+00	0.00%
Mn-54	1.770E+02	0.88%
Nb-94	2.610E-02	0.00%
Ni-59	5.680E+00	0.03%
Ni-63	1.030E+03	5.12%
Np-237	9.870E-06	0.00%
Pu-238	2.220E-02	0.00%
Pu-239	2.680E-04	0.00%
Pu-241	1.430E-02	0.00%
Pu-242	3.260E-08	0.00%
Sb-124	0.000E+00	0.00%
Sr-89	0.000E+00	0.00%
Sr-90	0.000E+00	0.00%
Tc-99	5.650E-03	0.00%
U-235	4.820E-05	0.00%
Zn-65	0.000E+00	0.00%
TOTAL ACTIVITY (Ci)	20.113	100.00%
CONTAINER VOLUME	1.74 ft ³	0.05 m ³

TABLE 2-19

WASTE CLASS	C	
SOURCE OF WASTE:	NON-PROCESSED DAW	
TYPE OF CONTAINER:	HIC	
METHOD OF PROCESS:	N/A	
ISOTOPES	ACTIVITY (mCi)	% OF TOTAL

Ag-110m	0.000E+00	0.00%
Am-241	0.000E+00	0.00%
C-14	<8.040E-03	0.00%
Ce 144	2.432E+02	0.36%
Cm-242	0.000E+00	0.00%
Cm-244	0.000E+00	0.00%
Co-58	1.257E+02	0.19%
Co-60	1.403E+04	21.04%
Cr-51	7.510E+02	1.13%
Cs-134	0.000E+00	0.00%
Cs-137	8.540E+01	0.13%
Fe-55	7.560E+03	11.34%
Fe-59	1.238E+03	1.86%
H-3	NP	0.00%
I-129	<1.073E-03	0.00%
I-131	0.000E+00	0.00%
Mn-54	4.260E+04	63.88%
Ni-59	0.000E+00	0.00%
Ni-63	1.012E+01	0.02%
Pu-238	0.000E+00	0.00%
Pu-239	0.000E+00	0.00%
Pu-241	0.000E+00	0.00%
Sb-124	0.000E+00	0.00%
Sr-89	0.000E+00	0.00%
Sr-90	0.000E+00	0.00%
Tc-99	3.910E+01	0.06%
Zn-65	0.000E+00	0.00%
TOTAL ACTIVITY (Ci)	66.683	100.00%
CONTAINER VOLUME	9.27 ft ³	0.26 m ³

TABLE 2-20

WASTE CLASS	C	
SOURCE OF WASTE:	CARTRIDGE FILTERS	
TYPE OF CONTAINER:	HIC	
METHOD OF PROCESS:	DEWATERED	
ISOTOPES	ACTIVITY (mCi)	% OF TOTAL
Ag-110m	0.000E+00	0.00%
Am-241	0.000E+00	0.00%
Ba-133	0.000E+00	0.00%
C-14	<2.840E-04	0.00%
Cd-109	0.000E+00	0.00%
Ce-139	0.000E+00	0.00%
Ce-141	0.000E+00	0.00%
Ce 144	1.080E+02	0.17%
Cm-242	0.000E+00	0.00%
Cm-244	0.000E+00	0.00%
Co-57	0.000E+00	0.00%
Co-58	5.480E+01	0.09%
Co-60	1.890E+04	30.30%
Cr-51	3.150E+02	0.51%
Cs-134	0.000E+00	0.00%
Cs-137	2.730E+02	0.44%
Fe-55	9.790E+03	15.70%
Fe-59	1.100E+03	1.76%
H-3	<1.437E-03	0.00%
Hg-203	0.000E+00	0.00%
I-129	3.920E-01	0.00%
I-131	0.000E+00	0.00%
Mn-54	3.160E+04	50.67%
Nb-95	0.000E+00	0.00%
Ni-59	0.000E+00	0.00%
Ni-63	3.810E+01	0.06%
Pu-238	0.000E+00	0.00%
Pu-239	0.000E+00	0.00%
Pu-241	0.000E+00	0.00%
Ru-106	0.000E+00	0.00%
Sb-124	0.000E+00	0.00%
Sn-113	0.000E+00	0.00%
Sr-85	0.000E+00	0.00%
Sr-89	0.000E+00	0.00%
Sr-90	0.000E+00	0.00%
Tc-99	1.750E+01	0.03%
Y-88	0.000E+00	0.00%
Zn-65	1.710E+02	0.27%
Zr-95	0.000E+00	0.00%
TOTAL ACTIVITY (Ci)	62.368	100.00%
CONTAINER VOLUME	109.29 ft3	3.09 m3

TABLE 2-21

WASTE CLASS		C
SOURCE OF WASTE:		IRRADIATED COMPONENTS
TYPE OF CONTAINER:		STEEL LINER
METHOD OF PROCESS:		DEWATERED
ISOTOPES	ACTIVITY (mCi)	% OF TOTAL
Ag-110m	0.000E+00	0.00%
Am-241	1.456E-02	0.00%
Am-243	1.963E-03	0.00%
C-14	1.074E+04	0.01%
Ce 144	0.000E+00	0.00%
Cm-242	3.013E+00	0.00%
Cm-243	1.311E+00	0.00%
Cm-244	0.000E+00	0.00%
Co-58	1.346E+04	0.01%
Co-60	1.093E+08	58.20%
Cr-51	1.130E+05	0.06%
Cs-134	0.000E+00	0.00%
Cs-137	0.000E+00	0.00%
Fe-55	6.930E+07	36.90%
Fe-59	0.000E+00	0.00%
H-3	1.264E+03	0.00%
I-129	0.000E+00	0.00%
I-131	0.000E+00	0.00%
Mn-54	1.183E+06	0.63%
Nb-94	1.908E+02	0.00%
Ni-59	4.323E+04	0.02%
Ni-63	7.838E+06	4.17%
Np-237	2.772E-03	0.00%
Pu-238	4.108E+01	0.00%
Pu-239	6.103E-02	0.00%
Pu-241	1.172E+01	0.00%
Pu-242	1.336E-04	0.00%
Sb-124	0.000E+00	0.00%
Sr-89	0.000E+00	0.00%
Sr-90	0.000E+00	0.00%
Tc-99	4.289E+01	0.00%
U-235	2.241E-04	0.00%
Zn-65	0.000E+00	0.00%
Zr-95	3.099E+00	0.00%
TOTAL ACTIVITY (Ci)	187802.908	100.00%
CONTAINER VOLUME	516.60 ft ³	14.63 m ³

SECTION 3
METEOROLOGICAL DATA AND DISPERSION ESTIMATES

METEOROLOGY AND DISPERSION DATA

Meteorological data have been collected at the Susquehanna SES (SSES) site since the early 1970s. At the present time, the meteorological system is based on a 300-foot high tower located approximately 1,000 feet to the southeast of the plant. Wind sensors are mounted at the 10m and 60m elevations on this tower. Vertical temperature differential is measured with redundant sensor pairs between the 10m and 60m levels. Sigma theta (the standard deviation of horizontal wind direction) is calculated from wind direction at both levels. Dew point and ambient temperature sensors are present at the 10m level. Precipitation is measured at ground level.

A back-up meteorological tower was erected in 1982. It is a 10m tower providing alternate measurements of wind speed, wind direction, and sigma theta. A 10m supplemental downriver meteorological tower is also available. This tower measures wind speed, wind direction, sigma theta, temperature and dew point.

SSES meteorological data is transmitted to the plant Control Room, Technical Support Center, and Emergency Operations Facility for emergency response availability. The data are also transmitted via telephone data line to EQE/PLG's offices in Bethesda, Maryland.

Dispersion modeling for effluents from normal operation of SSES is done using the EQE/PLG MIDAS system XDCALC program, a straight-line Gaussian plume model designed to estimate average relative concentration. The model was developed in accordance with Regulatory Guide 1.111. For periods when the wind speed is calm, the actual wind direction that occurred is used.

XDCALC and the XQINTR program that interpolates X/Q values to exact locations both use terrain correction factors to account for the temporal and spatial variations in the airflow in the region. A straight-line trajectory model assumes that a constant mean wind transports and diffuses effluents in the direction of airflow at the release point within the entire region of interest. The SSES terrain correction factors were taken from SSES FSAR Table 2.3-128.

TABLE 3-1

SSES METEOROLOGICAL DATA RECOVERY FOR 2000

PARAMETER	PERCENT VALID DATA RECOVERY
Wind Speed 10m – Primary ⁽¹⁾	99.8
Wind Speed 60m – Primary	99.4
Wind Speed 10m – Backup ⁽²⁾	99.9
Wind Speed 10m – Downriver ⁽³⁾	99.9
Wind Direction 10m – Primary	99.9
Wind Direction 60m – Primary	99.9
Wind Direction 10m – Backup	100.0
Wind Direction 10m – Downriver	100.0
Temperature 10m – Primary	99.8
Dew Point 10m – Primary	87.2
Delta Temperature 60m – Primary	99.8
Sigma Theta 10m – Primary	99.9
Sigma Theta 60m – Primary	99.9
Sigma Theta 10m- Backup	100.0
Sigma Theta 10m - Downriver	100.0
Precipitation – Primary	100.0
Composite Parameters	
Wind Speed and Direction 10m, Delta Temperature 60-10m	99.7
Wind Speed and Direction 60m, Delta Temperature 60-10m	99.3
⁽¹⁾ SSES “Primary” meteorological tower ⁽²⁾ SSES “Backup” meteorological tower ⁽³⁾ SSES “Downriver” meteorological tower	

TABLE 3-2

SSES Joint Frequency Distribution Of Wind Speed
 And Direction 10m Versus Delta Temperature 60-10m
 For The Period Of
 January 1, 2000 Through December 31, 2000

SITE: SSES

UNIT: 1 OR 2

HOURS AT EACH WIND SPEED AND DIRECTION

PERIOD OF RECORD = 00010101-00123124

STABILITY CLASS: A DT/DZ

ELEVATION: SPEED:10M SP DIRECTION:10M WD LAPSE:DT A

WIND DIRECTION	WIND SPEED (MPH)						TOTAL
	1-3	4-7	8-12	13-18	19-24	>24	
N	1	2	1	0	0	0	4
NNE	1	11	5	0	0	0	17
NE	1	17	1	0	0	0	19
ENE	1	4	2	0	0	0	7
E	5	1	0	0	0	0	6
ESE	6	2	0	0	0	0	8
SE	1	2	1	0	0	0	4
SSE	1	6	2	0	0	0	9
S	3	20	7	0	0	0	30
SSW	2	23	3	0	0	0	28
SW	3	46	32	0	0	0	81
WSW	0	1	10	2	0	0	13
W	0	1	5	0	0	0	6
WNW	0	0	0	0	0	0	0
NW	0	0	0	0	0	0	0
NNW	0	0	0	0	0	0	0
TOTAL	25	136	69	2	0	0	232

PERIODS OF CALM (HOURS): 2
 VARIABLE DIRECTION 0
 HOURS OF MISSING DATA: 24

TABLE 3-2
(continued)

SITE: SSES

UNIT: 1 OR 2

HOURS AT EACH WIND SPEED AND DIRECTION

PERIOD OF RECORD = 00010101-00123124

STABILITY CLASS: B DT/DZ

ELEVATION: SPEED:10M SP DIRECTION:10M WD LAPSE:DT A

WIND DIRECTION	WIND SPEED (MPH)						TOTAL
	1-3	4-7	8-12	13-18	19-24	>24	
N	0	2	8	2	0	0	12
NNE	1	20	2	0	0	0	23
NE	6	17	1	0	0	0	24
ENE	4	3	1	0	0	0	8
E	3	3	0	0	0	0	6
ESE	7	7	0	0	0	0	14
SE	0	1	5	0	0	0	6
SSE	0	3	1	0	0	0	4
S	2	17	3	0	0	0	22
SSW	2	21	2	1	0	0	26
SW	0	44	22	2	0	0	68
WSW	1	8	19	5	0	0	33
W	0	3	9	1	0	0	13
WNW	0	0	5	0	0	0	5
NW	0	2	1	0	0	0	3
NNW	0	3	0	0	0	0	3
TOTAL	26	154	79	11	0	0	270

PERIODS OF CALM (HOURS): 2

VARIABLE DIRECTION 0

HOURS OF MISSING DATA: 24

**TABLE 3-2
(continued)**

SITE: SSES

UNIT: 1 OR 2

HOURS AT EACH WIND SPEED AND DIRECTION
 PERIOD OF RECORD = 00010101-00123124
 STABILITY CLASS: C DT/DZ
 ELEVATION: SPEED:10M SP DIRECTION:10M WD LAPSE:DT A

WIND DIRECTION	WIND SPEED (MPH)						TOTAL
	1-3	4-7	8-12	13-18	19-24	>24	
N	3	8	7	0	0	0	18
NNE	5	15	7	0	0	0	27
NE	2	29	1	0	0	0	32
ENE	5	8	1	0	0	0	14
E	5	3	0	0	0	0	8
ESE	4	8	0	0	0	0	12
SE	2	3	3	0	0	0	8
SSE	2	8	2	0	0	0	12
S	7	22	5	0	0	0	34
SSW	4	32	1	0	0	0	37
SW	3	61	29	2	0	0	95
WSW	3	18	30	5	0	0	56
W	1	2	15	4	0	0	22
WNW	0	7	5	0	0	0	12
NW	1	3	3	0	0	0	7
NNW	0	6	5	1	0	0	12
TOTAL	47	233	114	12	0	0	406

PERIODS OF CALM (HOURS): 2
 VARIABLE DIRECTION 0
 HOURS OF MISSING DATA: 24

TABLE 3-2
(continued)

SITE: SSES

UNIT: 1 OR 2

HOURS AT EACH WIND SPEED AND DIRECTION
 PERIOD OF RECORD = 00010101-00123124
 STABILITY CLASS: D DT/DZ
 ELEVATION: SPEED:10M SP DIRECTION:10M WD LAPSE:DT A

WIND DIRECTION	WIND SPEED (MPH)						TOTAL
	1-3	4-7	8-12	13-18	19-24	>24	
N	36	168	132	12	0	0	348
NNE	85	192	24	0	0	0	301
NE	142	177	8	0	0	0	327
ENE	123	76	2	0	0	0	201
E	129	68	4	1	0	0	202
ESE	94	46	7	2	0	0	149
SE	109	66	11	0	0	0	186
SSE	74	54	4	0	0	0	132
S	73	80	10	0	0	0	163
SSW	75	118	5	0	0	0	198
SW	76	202	120	13	0	0	411
WSW	36	94	136	70	7	1	344
W	16	80	88	11	2	0	197
WNW	13	68	78	12	0	0	171
NW	9	83	146	12	0	0	250
NNW	13	112	200	30	0	0	355
TOTAL	1103	1684	975	163	9	1	3935

PERIODS OF CALM(HOURS): 2
 VARIABLE DIRECTION 0
 HOURS OF MISSING DATA: 24

TABLE 3-2
(continued)

SITE: SSES

UNIT: 1 OR 2

HOURS AT EACH WIND SPEED AND DIRECTION

PERIOD OF RECORD = 00010101-00123124

STABILITY CLASS: E DT/DZ

ELEVATION: SPEED:10M SP DIRECTION:10M WD LAPSE:DT A

WIND DIRECTION	WIND SPEED (MPH)						TOTAL
	1-3	4-7	8-12	13-18	19-24	>24	
N	28	47	3	0	0	0	78
NNE	114	71	1	0	0	0	186
NE	206	62	1	0	0	0	269
ENE	295	20	1	0	0	0	316
E	181	6	0	0	0	0	187
ESE	97	2	1	0	0	0	102
SE	111	14	1	0	0	0	126
SSE	110	13	3	0	0	0	126
S	174	53	9	0	0	0	236
SSW	141	100	12	0	0	0	253
SW	59	107	22	1	0	0	189
WSW	19	16	6	1	0	0	42
W	10	7	0	0	0	0	17
WNW	2	15	0	0	0	0	17
NW	9	30	1	0	0	0	40
NNW	10	35	2	0	0	0	47
TOTAL	1566	598	63	2	0	0	2231

PERIODS OF CALM(HOURS): 2

VARIABLE DIRECTION 0

HOURS OF MISSING DATA: 24

**TABLE 3-2
(continued)**

SITE: SSES

UNIT: 1 OR 2

HOURS AT EACH WIND SPEED AND DIRECTION

PERIOD OF RECORD = 00010101-00123124

STABILITY CLASS: F DT/DZ

ELEVATION: SPEED:10M SP DIRECTION:10M WD LAPSE:DT A

WIND DIRECTION	WIND SPEED (MPH)						TOTAL
	1-3	4-7	8-12	13-18	19-24	>24	
N	9	5	0	0	0	0	14
NNE	32	4	0	0	0	0	36
NE	105	4	0	0	0	0	109
ENE	448	18	0	0	0	0	466
E	186	1	0	0	0	0	187
ESE	46	0	0	0	0	0	46
SE	37	0	0	0	0	0	37
SSE	25	0	0	0	0	0	25
S	50	2	0	0	0	0	52
SSW	31	6	0	0	0	0	37
SW	12	8	0	0	0	0	20
WSW	1	0	0	0	0	0	1
W	4	0	0	0	0	0	4
WNW	1	0	0	0	0	0	1
NW	1	0	0	0	0	0	1
NNW	1	2	0	0	0	0	3
TOTAL	989	50	0	0	0	0	1039

PERIODS OF CALM (HOURS): 2

VARIABLE DIRECTION 0

HOURS OF MISSING DATA: 24

TABLE 3-2
(continued)

SITE: SSES UNIT: 1 OR 2

HOURS AT EACH WIND SPEED AND DIRECTION

PERIOD OF RECORD = 00010101-00123124

STABILITY CLASS: G DT/DZ

ELEVATION: SPEED:10M SP DIRECTION:10M WD LAPSE:DT A

WIND DIRECTION	WIND SPEED (MPH)						TOTAL
	1-3	4-7	8-12	13-18	19-24	>24	
N	1	0	0	0	0	0	1
NNE	10	0	0	0	0	0	10
NE	75	2	0	0	0	0	77
ENE	381	20	0	0	0	0	401
E	90	0	0	0	0	0	90
ESE	22	0	0	0	0	0	22
SE	18	0	0	0	0	0	18
SSE	12	0	0	0	0	0	12
S	9	0	0	0	0	0	9
SSW	7	0	0	0	0	0	7
SW	0	0	0	0	0	0	0
WSW	0	0	0	0	0	0	0
W	0	0	0	0	0	0	0
WNW	0	0	0	0	0	0	0
NW	0	0	0	0	0	0	0
NNW	0	0	0	0	0	0	0
TOTAL	625	22	0	0	0	0	647

PERIODS OF CALM(HOURS): 2

VARIABLE DIRECTION 0

HOURS OF MISSING DATA: 24

TABLE 3-2
(continued)

SITE: SSES

UNIT: 1 OR 2

HOURS AT EACH WIND SPEED AND DIRECTION

PERIOD OF RECORD = 00010101-00123124

STABILITY CLASS: ALL DT/DZ

ELEVATION: SPEED:10M SP DIRECTION:10M WD LAPSE:DT A

WIND DIRECTION	WIND SPEED (MPH)						TOTAL
	1-3	4-7	8-12	13-18	19-24	>24	
N	78	232	151	14	0	0	475
NNE	248	313	39	0	0	0	600
NE	537	308	12	0	0	0	857
ENE	1257	149	7	0	0	0	1413
E	599	82	4	1	0	0	686
ESE	276	65	8	2	0	0	353
SE	278	86	21	0	0	0	385
SSE	224	84	12	0	0	0	320
S	318	194	34	0	0	0	546
SSW	262	300	23	1	0	0	586
SW	153	468	225	18	0	0	864
WSW	60	137	201	83	7	1	489
W	31	93	117	16	2	0	259
WNW	16	90	88	12	0	0	206
NW	20	118	151	12	0	0	301
NNW	24	158	207	31	0	0	420
TOTAL	4381	2877	1300	190	9	1	8760

PERIODS OF CALM(HOURS): 2

VARIABLE DIRECTION 0

HOURS OF MISSING DATA: 24

TABLE 3-3

1 of 8

SSES Joint Frequency Distribution Of Wind Speed
 And Direction 60m Versus Delta Temperature 60-10m
 For The Period Of
 January 1, 2000 Through December 31, 2000

SITE: SSES

UNIT: 1 OR 2

HOURS AT EACH WIND SPEED AND DIRECTION

PERIOD OF RECORD = 00010101-00123124

STABILITY CLASS: A DT/DZ

ELEVATION: SPEED:60M SP DIRECTION:60M WD LAPSE:DT A

WIND DIRECTION	WIND SPEED (MPH)						TOTAL
	1-3	4-7	8-12	13-18	19-24	>24	
N	0	0	5	1	0	0	6
NNE	0	3	12	1	0	0	16
NE	3	11	10	1	0	0	25
ENE	2	2	0	0	0	0	4
E	2	3	1	0	0	0	6
ESE	1	0	1	0	0	0	2
SE	2	1	1	1	0	0	5
SSE	0	1	4	1	0	0	6
S	0	3	11	12	1	0	27
SSW	1	12	11	5	0	0	29
SW	2	8	45	22	0	0	77
WSW	0	0	7	15	2	0	24
W	0	0	2	1	0	0	3
WNW	0	0	0	0	0	0	0
NW	0	0	0	0	0	0	0
NNW	0	0	0	0	0	0	0
TOTAL	13	44	110	60	3	0	230

PERIODS OF CALM(HOURS) : 0

VARIABLE DIRECTION 0

HOURS OF MISSING DATA: 62

TABLE 3-3
(continued)

SITE: SSES

UNIT: 1 OR 2

HOURS AT EACH WIND SPEED AND DIRECTION

PERIOD OF RECORD = 00010101-00123124

STABILITY CLASS: B DT/DZ

ELEVATION: SPEED:60M SP DIRECTION:60M WD LAPSE:DT A

WIND DIRECTION	WIND SPEED (MPH)						TOTAL
	1-3	4-7	8-12	13-18	19-24	>24	
N	0	4	6	3	1	0	14
NNE	1	9	8	1	0	0	19
NE	5	13	12	0	0	0	30
ENE	2	6	0	0	0	0	8
E	2	2	0	0	0	0	4
ESE	0	5	4	0	0	0	9
SE	1	1	2	2	1	0	7
SSE	0	0	3	1	0	0	4
S	0	5	7	6	0	0	18
SSW	0	11	13	4	0	1	29
SW	0	21	33	15	1	0	70
WSW	0	2	12	14	4	0	32
W	0	1	4	7	1	0	13
WNW	0	1	2	3	0	0	6
NW	0	1	1	0	0	0	2
NNW	0	1	0	2	0	0	3
TOTAL	11	83	107	58	8	1	268

PERIODS OF CALM(HOURS): 0

VARIABLE DIRECTION 0

HOURS OF MISSING DATA: 62

TABLE 3-3
(continued)

SITE: SSES

UNIT: 1 OR 2

HOURS AT EACH WIND SPEED AND DIRECTION

PERIOD OF RECORD = 00010101-00123124

STABILITY CLASS: C DT/DZ

ELEVATION: SPEED:60M SP DIRECTION:60M WD LAPSE:DT A

WIND DIRECTION	WIND SPEED (MPH)						TOTAL
	1-3	4-7	8-12	13-18	19-24	>24	
N	1	6	5	4	0	0	16
NNE	7	17	13	2	0	0	39
NE	3	12	9	1	0	0	25
ENE	1	9	2	0	0	0	12
E	5	1	0	0	0	0	6
ESE	1	2	7	0	0	0	10
SE	1	2	5	1	0	0	9
SSE	0	3	5	1	1	0	10
S	5	7	10	3	1	0	26
SSW	1	25	10	4	1	0	41
SW	0	26	49	14	4	0	93
WSW	0	8	27	26	5	0	66
W	0	1	8	13	1	0	23
WNW	0	2	6	2	0	0	10
NW	0	1	1	0	0	0	2
NNW	0	1	7	6	0	0	14
TOTAL	25	123	164	77	13	0	402

PERIODS OF CALM(HOURS): 0

VARIABLE DIRECTION 0

HOURS OF MISSING DATA: 62

**TABLE 3-3
(continued)**

SITE: SSES

UNIT: 1 OR 2

HOURS AT EACH WIND SPEED AND DIRECTION

PERIOD OF RECORD = 00010101-00123124

STABILITY CLASS: D DT/DZ

ELEVATION: SPEED:60M SP DIRECTION:60M WD LAPSE:DT A

WIND DIRECTION	WIND SPEED (MPH)						TOTAL
	1-3	4-7	8-12	13-18	19-24	>24	
N	18	74	141	52	3	0	288
NNE	46	142	134	24	0	0	346
NE	73	120	87	8	0	0	288
ENE	47	70	39	3	0	0	159
E	45	69	32	4	5	0	155
ESE	32	45	32	6	1	0	116
SE	40	60	39	9	2	0	150
SSE	37	67	34	5	1	0	144
S	28	40	43	18	5	0	134
SSW	44	63	63	23	5	0	198
SW	38	144	153	69	6	2	412
WSW	8	62	132	191	71	18	482
W	2	31	107	91	10	3	244
WNW	2	24	81	38	9	0	154
NW	4	36	196	79	4	0	319
NNW	5	34	185	97	9	0	330
TOTAL	469	1081	1498	717	131	23	3919

PERIODS OF CALM(HOURS): 0

VARIABLE DIRECTION 0

HOURS OF MISSING DATA: 62

**TABLE 3-3
(continued)**

SITE: SSES

UNIT: 1 OR 2

HOURS AT EACH WIND SPEED AND DIRECTION

PERIOD OF RECORD = 00010101-00123124

STABILITY CLASS: E DT/DZ

ELEVATION: SPEED:60M SP DIRECTION:60M WD LAPSE:DT A

WIND DIRECTION	WIND SPEED (MPH)						TOTAL
	1-3	4-7	8-12	13-18	19-24	>24	
N	21	62	26	0	0	0	109
NNE	79	197	51	7	0	0	334
NE	127	116	33	3	0	0	279
ENE	59	54	9	0	0	0	122
E	61	21	12	0	0	0	94
ESE	28	17	7	1	0	0	53
SE	23	27	14	5	1	0	70
SSE	44	48	19	3	0	0	114
S	55	56	52	10	7	1	181
SSW	38	68	94	28	4	1	233
SW	35	109	126	27	4	0	301
WSW	14	43	63	59	1	0	180
W	1	17	7	0	0	0	25
WNW	4	9	20	0	0	0	33
NW	6	16	41	0	0	0	63
NNW	4	19	10	1	0	0	34
TOTAL	599	879	584	144	17	2	2225

PERIODS OF CALM(HOURS): 0

VARIABLE DIRECTION 0

HOURS OF MISSING DATA: 62

TABLE 3-3
(continued)

SITE: SSES

UNIT: 1 OR 2

HOURS AT EACH WIND SPEED AND DIRECTION

PERIOD OF RECORD = 00010101-00123124

STABILITY CLASS: F DT/DZ

ELEVATION: SPEED:60M SP DIRECTION:60M WD LAPSE:DT A

WIND DIRECTION	WIND SPEED (MPH)						TOTAL
	1-3	4-7	8-12	13-18	19-24	>24	
N	15	49	6	0	0	0	70
NNE	64	253	6	0	0	0	323
NE	86	90	1	0	0	0	177
ENE	60	14	0	0	0	0	74
E	38	12	0	0	0	0	50
ESE	26	3	0	0	0	0	29
SE	32	8	0	0	0	0	40
SSE	25	10	0	0	0	0	35
S	14	24	5	0	0	0	43
SSW	13	30	13	0	0	0	56
SW	8	31	20	4	0	0	63
WSW	3	7	20	8	0	0	38
W	2	2	0	0	0	0	4
WNW	0	5	0	0	0	0	5
NW	1	8	2	0	0	0	11
NNW	7	6	1	0	0	0	14
TOTAL	394	552	74	12	0	0	1032

PERIODS OF CALM (HOURS): 0

VARIABLE DIRECTION 0

HOURS OF MISSING DATA: 62

**TABLE 3-3
(continued)**

7 of 8

SITE: SSES

UNIT: 1 OR 2

HOURS AT EACH WIND SPEED AND DIRECTION

PERIOD OF RECORD = 00010101-00123124

STABILITY CLASS: G DT/DZ

ELEVATION: SPEED:60M SP DIRECTION:60M WD LAPSE:DT A

WIND DIRECTION	WIND SPEED (MPH)						TOTAL
	1-3	4-7	8-12	13-18	19-24	>24	
N	11	61	4	0	0	0	76
NNE	56	151	2	0	0	0	209
NE	61	36	0	0	0	0	97
ENE	25	4	0	0	0	0	29
E	36	2	0	0	0	0	38
ESE	24	1	0	0	0	0	25
SE	20	7	0	0	0	0	27
SSE	15	5	0	0	0	0	20
S	10	16	2	0	0	0	28
SSW	2	19	10	0	0	0	31
SW	9	19	11	2	0	0	41
WSW	3	1	4	1	0	0	9
W	0	0	0	0	0	0	0
WNW	0	1	0	0	0	0	1
NW	2	2	1	0	0	0	5
NNW	1	8	1	0	0	0	10
TOTAL	275	333	35	3	0	0	646

PERIODS OF CALM (HOURS): 0

VARIABLE DIRECTION 0

HOURS OF MISSING DATA: 62

TABLE 3-3
(continued)

SITE: SSES

UNIT: 1 OR 2

HOURS AT EACH WIND SPEED AND DIRECTION

PERIOD OF RECORD = 00010101-00123124

STABILITY CLASS: ALL DT/DZ

ELEVATION: SPEED:60M SP DIRECTION:60M WD LAPSE:DT A

WIND DIRECTION	WIND SPEED (MPH)						TOTAL
	1-3	4-7	8-12	13-18	19-24	>24	
N	66	256	193	60	4	0	579
NNE	253	772	226	35	0	0	1286
NE	358	398	152	13	0	0	921
ENE	196	159	50	3	0	0	408
E	189	110	45	4	5	0	353
ESE	112	73	51	7	1	0	244
SE	119	106	61	18	4	0	308
SSE	121	134	65	11	2	0	333
S	112	151	130	49	14	1	457
SSW	99	228	214	64	10	2	617
SW	92	358	437	153	15	2	1057
WSW	28	123	265	314	83	18	831
W	5	52	128	112	12	3	312
WNW	6	42	109	43	9	0	209
NW	13	64	242	79	4	0	402
NNW	17	69	204	106	9	0	405
TOTAL	1786	3095	2572	1071	172	26	8722
PERIODS OF CALM(HOURS):	0						
VARIABLE DIRECTION	0						
HOURS OF MISSING DATA:	62						

TABLE 3-4

2000 SSES ANNUAL RELATIVE CONCENTRATIONS NO DECAY, UNDEPLETED X/Q (sec/m³)

DATES OF LAST X/Q ACCUMULATION ARE FROM 0 1 1 1 0 TO 0123124 0
X/Q ACCUMULATION FOR GROUND AVERAGE SEC/M3
FOR RELEASE POINT 1

	MILES									
	0.5-1	1-2	2-3	3-4	4-5	5-10	10-20	20-30	30-40	40-50
**DIRECTION FROM N										
1.7362E-06	3.4251E-07	1.5690E-07	9.1220E-08	6.2960E-08	3.0334E-08	1.1109E-08	5.3270E-09	3.3267E-09	2.3329E-09	
**DIRECTION FROM NNE										
3.6180E-06	.1689E-07	3.3524E-07	1.9913E-07	1.3974E-07	6.9681E-08	2.6812E-08	1.3199E-08	8.3853E-09	6.0013E-09	
**DIRECTION FROM NE										
8.0607E-06	1.5373E-06	7.3517E-07	4.5056E-07	3.2082E-07	1.6399E-07	6.5688E-08	3.2960E-08	2.1163E-08	1.5362E-08	
**DIRECTION FROM ENE										
2.1220E-05	3.8557E-06	1.8980E-06	1.2066E-06	8.7238E-07	4.5684E-07	1.9018E-07	9.7127E-08	6.2969E-08	4.6261E-08	
**DIRECTION FROM E										
1.0100E-05	1.9152E-06	9.3675E-07	5.8332E-07	4.1752E-07	2.1501E-07	8.7499E-08	4.4329E-08	2.8637E-08	2.0879E-08	
**DIRECTION FROM ESE										
4.1176E-06	8.0342E-07	3.8298E-07	2.3203E-07	1.6425E-07	8.3112E-08	3.2810E-08	1.6373E-08	1.0485E-08	7.5705E-09	
**DIRECTION FROM SE										
4.1213E-06	8.1621E-07	3.8659E-07	2.3243E-07	1.6409E-07	8.2678E-08	3.2353E-08	1.6058E-08	1.0249E-08	7.3748E-09	
**DIRECTION FROM SSE										
2.9641E-06	5.9701E-07	2.8134E-07	1.6785E-07	1.1829E-07	5.9520E-08	2.3161E-08	1.1465E-08	7.3098E-09	5.2511E-09	
**DIRECTION FROM S										
3.8830E-06	7.8883E-07	3.7346E-07	2.2259E-07	1.5692E-07	7.9073E-08	3.0846E-08	1.5329E-08	9.8086E-09	7.0576E-09	
**DIRECTION FROM SSW										
3.4452E-06	6.9823E-07	3.2699E-07	1.9337E-07	1.3585E-07	6.8062E-08	2.6269E-08	1.2973E-08	8.2687E-09	5.9295E-09	
**DIRECTION FROM SW										
2.9304E-06	5.7176E-07	2.6239E-07	1.5279E-07	1.0585E-07	5.1511E-08	1.9148E-08	9.3023E-09	5.8736E-09	4.1613E-09	
**DIRECTION FROM WSW										
1.2289E-06	2.3480E-07	1.0519E-07	6.0246E-08	4.1162E-08	1.9435E-08	6.8946E-09	3.2540E-09	2.0142E-09	1.3988E-09	
**DIRECTION FROM W										
7.5654E-07	1.4567E-07	6.6423E-08	3.8546E-08	2.6473E-08	1.2603E-08	4.5534E-09	2.1707E-09	1.3507E-09	9.4244E-10	
**DIRECTION FROM WNW										
5.9477E-07	1.1496E-07	5.1899E-08	2.9873E-08	2.0412E-08	9.6122E-09	3.4049E-09	1.6007E-09	9.8582E-10	6.8091E-10	
**DIRECTION FROM NW										
8.3328E-07	1.6487E-07	7.4412E-08	4.2719E-08	2.9280E-08	1.3913E-08	4.9654E-09	2.3398E-09	1.4430E-09	9.9924E-10	
**DIRECTION FROM NNW										
1.1605E-06	2.2672E-07	1.0252E-07	5.9210E-08	4.0681E-08	1.9407E-08	6.9839E-09	3.3042E-09	2.0419E-09	1.4194E-09	

TABLE 3-5

2000 SSES ANNUAL RELATIVE CONCENTRATIONS 2.26 -DAY DECAY, UNDEPLETED X/Q (sec/m³)

DATES OF LAST X/Q ACCUMULATION ARE FROM 0 1 1 0 TO 0123124 0
 X/Q ACCUMULATION FOR GROUND DECAYED S.AVG SEC/M3
 FOR RELEASE POINT 1

		MILES									
		0.5-1	1-2	2-3	3-4	4-5	5-10	10-20	20-30	30-40	40-50
**DIRECTION FROM N											
1.7331E-06	3.4069E-07	1.5551E-07	9.0079E-08	6.1946E-08	2.9517E-08	1.0513E-08	4.8575E-09	2.9233E-09	1.9754E-09		
**DIRECTION FROM NNE											
3.6089E-06	7.1151E-07	3.3103E-07	1.9559E-07	1.3653E-07	6.7006E-08	2.4762E-08	1.1555E-08	6.9606E-09	4.7217E-09		
**DIRECTION FROM NE											
8.0361E-06	1.5234E-06	7.2403E-07	4.4096E-07	3.1203E-07	1.5653E-07	5.9798E-08	2.8178E-08	1.6996E-08	1.1588E-08		
**DIRECTION FROM ENE											
2.1154E-05	3.8198E-06	1.8686E-06	1.1806E-06	8.4829E-07	4.3604E-07	1.7330E-07	8.3224E-08	5.0749E-08	3.5084E-08		
**DIRECTION FROM E											
1.0062E-05	1.8935E-06	9.1910E-07	5.6796E-07	4.0343E-07	2.0303E-07	7.8013E-08	3.6619E-08	2.1924E-08	1.4818E-08		
**DIRECTION FROM ESE											
4.1017E-06	7.9404E-07	3.7554E-07	2.2573E-07	1.5854E-07	7.8339E-08	2.9143E-08	1.3439E-08	7.9558E-09	5.3108E-09		
**DIRECTION FROM SE											
4.1057E-06	8.0694E-07	3.7926E-07	2.2626E-07	1.5848E-07	7.7999E-08	2.8769E-08	1.3200E-08	7.7896E-09	5.1826E-09		
**DIRECTION FROM SSE											
2.9542E-06	5.9098E-07	2.7660E-07	1.6389E-07	1.1471E-07	5.6539E-08	2.0891E-08	9.6541E-09	5.7477E-09	3.8568E-09		
**DIRECTION FROM S											
3.8722E-06	7.8218E-07	3.6822E-07	2.1821E-07	1.5296E-07	7.5764E-08	2.8314E-08	1.3293E-08	8.0393E-09	5.4687E-09		
**DIRECTION FROM SSW											
3.4372E-06	6.9331E-07	3.2314E-07	1.9018E-07	1.3296E-07	6.5652E-08	2.4431E-08	1.1496E-08	6.9829E-09	4.7725E-09		
**DIRECTION FROM SW											
2.9251E-06	5.6862E-07	2.5997E-07	1.5081E-07	1.0408E-07	5.0075E-08	1.8087E-08	8.4597E-09	5.1444E-09	3.5109E-09		
**DIRECTION FROM WSW											
1.2271E-06	2.3376E-07	1.0442E-07	5.9624E-08	4.0613E-08	1.9001E-08	6.5860E-09	3.0143E-09	1.8098E-09	1.2189E-09		
**DIRECTION FROM W											
7.5526E-07	1.4491E-07	6.5829E-08	3.8054E-08	2.6034E-08	1.2248E-08	4.2914E-09	1.9637E-09	1.1729E-09	7.8512E-10		
**DIRECTION FROM WNW											
5.9387E-07	1.1444E-07	5.1497E-08	2.9543E-08	2.0120E-08	9.3806E-09	3.2382E-09	1.4707E-09	8.7515E-10	5.8392E-10		
**DIRECTION FROM NW											
8.3219E-07	1.6421E-07	7.3912E-08	4.2316E-08	2.8923E-08	1.3628E-08	4.7610E-09	2.1805E-09	1.3069E-09	8.7938E-10		
**DIRECTION FROM NNW											
1.1588E-06	2.2574E-07	1.0178E-07	5.8600E-08	4.0136E-08	1.8965E-08	6.6581E-09	3.0487E-09	1.8237E-09	1.2261E-09		

TABLE 3-6

2000 SSES ANNUAL RELATIVE CONCENTRATIONS 8-DAY DECAY, DEPLETED X/Q (sec/m³)

DATES OF LAST X/Q ACCUMULATION ARE FROM X/Q ACCUMULATION FOR DECAYED DEPLETION FOR RELEASE POINT 1		0 1 1 0 TO 0123124 0 SEC/M3		MILES							
		0.5-1	1-2	2-3	3-4	4-5	5-10	10-20	20-30	30-40	40-50
**DIRECTION FROM N											
1.5863E-06	2.9013E-07	1.2691E-07	7.0682E-08	4.7169E-08	2.1106E-08	6.8503E-09	2.8678E-09	1.6055E-09	1.0219E-09		
**DIRECTION FROM NNE											
3.3049E-06	6.0689E-07	2.7087E-07	1.5407E-07	1.0449E-07	4.8322E-08	1.6420E-08	7.0241E-09	3.9818E-09	2.5744E-09		
**DIRECTION FROM NE											
7.3620E-06	1.3009E-06	5.9357E-07	3.4824E-07	2.3958E-07	1.1349E-07	4.0066E-08	1.7424E-08	9.9580E-09	6.5139E-09		
**DIRECTION FROM ENE											
1.9380E-05	3.2624E-06	1.5323E-06	9.3254E-07	6.5142E-07	3.1615E-07	1.1604E-07	5.1383E-08	2.9663E-08	1.9650E-08		
**DIRECTION FROM E											
9.2226E-06	1.6196E-06	7.5553E-07	4.5019E-07	3.1121E-07	1.4834E-07	5.3058E-08	2.3210E-08	1.3295E-08	8.7033E-09		
**DIRECTION FROM ESE											
3.7599E-06	6.7933E-07	3.0884E-07	1.7903E-07	1.2239E-07	5.7312E-08	1.9874E-08	8.5572E-09	4.8557E-09	3.1454E-09		
**DIRECTION FROM SE											
3.7633E-06	6.9021E-07	3.1179E-07	1.7937E-07	1.2230E-07	5.7027E-08	1.9602E-08	8.3950E-09	4.7474E-09	3.0644E-09		
**DIRECTION FROM SSE											
2.7070E-06	5.0503E-07	2.2704E-07	1.2964E-07	8.8262E-08	4.1134E-08	1.4090E-08	6.0350E-09	3.4188E-09	2.2097E-09		
**DIRECTION FROM S											
3.5467E-06	6.6761E-07	3.0163E-07	1.7212E-07	1.1725E-07	5.4779E-08	1.8858E-08	8.1362E-09	4.6418E-09	3.0154E-09		
**DIRECTION FROM SSW											
3.1472E-06	5.9117E-07	2.6426E-07	1.4966E-07	1.0163E-07	4.7241E-08	1.6120E-08	6.9283E-09	3.9466E-09	2.5611E-09		
**DIRECTION FROM SW											
2.6773E-06	4.8430E-07	2.1221E-07	1.1838E-07	7.9288E-08	3.5831E-08	1.1801E-08	5.0042E-09	2.8322E-09	1.8211E-09		
**DIRECTION FROM WSW											
1.1229E-06	1.9894E-07	8.5121E-08	4.6711E-08	3.0863E-08	1.3541E-08	4.2628E-09	1.7597E-09	9.7834E-10	6.1786E-10		
**DIRECTION FROM W											
6.9123E-07	1.2340E-07	5.3725E-08	2.9865E-08	1.9831E-08	8.7656E-09	2.8043E-09	1.1656E-09	6.4930E-10	4.1053E-10		
**DIRECTION FROM WNW											
5.4345E-07	9.7402E-08	4.1992E-08	2.3156E-08	1.5300E-08	6.6935E-09	2.1024E-09	8.6337E-10	4.7692E-10	2.9911E-10		
**DIRECTION FROM NW											
7.6143E-07	1.3971E-07	6.0225E-08	3.3130E-08	2.1961E-08	9.6984E-09	3.0733E-09	1.2674E-09	7.0239E-10	4.4255E-10		
**DIRECTION FROM NNW											
1.0604E-06	1.9210E-07	8.2963E-08	4.5907E-08	3.0502E-08	1.3519E-08	4.3153E-09	1.7844E-09	9.8959E-10	6.2487E-10		

TABLE 3-7

2000 SSES ANNUAL RELATIVE DEPOSITION - D/Q (meters⁻²)

DATES OF LAST X/Q ACCUMULATION ARE FROM 0 1 1 1 0 TO 0123124 0
X/Q ACCUMULATION FOR DEPOSITION 1/MZ

	0.5-1	1-2	2-3	3-4	MILES				40-50	
					4-5	5-10	10-20	20-30	30-40	
**DIRECTION FROM N										
1.1019E-08	1.6854E-09	7.6361E-10	4.0065E-10	2.5581E-10	1.0685E-10	3.4789E-11	1.2809E-11	6.8365E-12	4.2949E-12	
**DIRECTION FROM NNE										
1.3942E-08	2.1325E-09	9.6617E-10	5.0693E-10	3.2367E-10	1.3519E-10	4.4017E-11	1.6206E-11	8.6499E-12	5.4342E-12	
**DIRECTION FROM NE										
1.9881E-08	3.0409E-09	1.3777E-09	7.2286E-10	4.6153E-10	1.9278E-10	6.2767E-11	2.3110E-11	1.2334E-11	7.7490E-12	
**DIRECTION FROM ENE										
3.2780E-08	5.0138E-09	2.2715E-09	1.1918E-09	7.6097E-10	3.1784E-10	1.0349E-10	3.8102E-11	2.0337E-11	1.2776E-11	
**DIRECTION FROM E										
1.5914E-08	2.4341E-09	1.1028E-09	5.7863E-10	3.6944E-10	1.5431E-10	5.0243E-11	1.8498E-11	9.8733E-12	6.2028E-12	
**DIRECTION FROM ESE										
8.1891E-09	1.2526E-09	5.6748E-10	2.9775E-10	1.9011E-10	7.9405E-11	2.5854E-11	9.5189E-12	5.0806E-12	3.1918E-12	
**DIRECTION FROM SE										
8.9314E-09	1.3661E-09	6.1892E-10	3.2474E-10	2.0734E-10	8.6603E-11	2.8197E-11	1.0382E-11	5.5411E-12	3.4811E-12	
**DIRECTION FROM SSE										
7.4235E-09	1.1355E-09	5.1443E-10	2.6991E-10	1.7233E-10	7.1982E-11	2.3437E-11	8.6290E-12	4.6056E-12	2.8934E-12	
**DIRECTION FROM S										
1.2666E-08	1.9374E-09	8.7775E-10	4.6054E-10	2.9405E-10	1.2282E-10	3.9989E-11	1.4723E-11	7.8583E-12	4.9369E-12	
**DIRECTION FROM SSW										
1.3618E-08	2.0829E-09	9.4366E-10	4.9512E-10	3.1613E-10	1.3204E-10	4.2992E-11	1.5829E-11	8.4484E-12	5.3076E-12	
**DIRECTION FROM SW										
2.0067E-08	3.0693E-09	1.3906E-09	7.2961E-10	4.6584E-10	1.9458E-10	6.3353E-11	2.3325E-11	1.2450E-11	7.8213E-12	
**DIRECTION FROM WSW										
1.1344E-08	1.7351E-09	7.8611E-10	4.1246E-10	2.6335E-10	1.1000E-10	3.5814E-11	1.3186E-11	7.0380E-12	4.4215E-12	
**DIRECTION FROM W										
6.0084E-09	9.1901E-10	4.1637E-10	2.1846E-10	1.3948E-10	5.8260E-11	1.8969E-11	6.9841E-12	3.7277E-12	2.3419E-12	
**DIRECTION FROM WNW										
4.7789E-09	7.3095E-10	3.3116E-10	1.7376E-10	1.1094E-10	4.6338E-11	1.5087E-11	5.5549E-12	2.9649E-12	1.8626E-12	
**DIRECTION FROM NW										
6.9828E-09	1.0680E-09	4.8389E-10	2.5389E-10	1.6210E-10	6.7708E-11	2.2045E-11	8.1167E-12	4.3322E-12	2.7216E-12	
**DIRECTION FROM NNW										
9.7666E-09	1.4938E-09	6.7680E-10	3.5510E-10	2.2673E-10	9.4701E-11	3.0834E-11	1.1353E-11	6.0593E-12	3.8066E-12	

TABLE 3-8

**2000 ATMOSPHERIC DISPERSION ESTIMATES
FOR GASPAR INPUT AT SELECTED LOCATIONS**

AFFECTED SECTOR	LOCATION	MILES	X/Q	X/Q DEC	X/Q DEC+DEP	DEPOSITION
14/WNW	Maximum (X/Q) Site Boundary	0.6	1.221E-5	1.215E-5	1.100E-5	2.097E-8
9/S	Closest (X/Q) Site Boundary	0.38	4.984E-6	4.980E-6	4.640E-6	3.868E-8
12/WSW	Maximum (X/Q) Residence	1.1	9.580E-6	9.508E-6	8.283E-6	1.580E-8
8/SSE	Maximum (D/Q) Residence	0.6	2.053E-6	2.049E-6	1.852E-6	1.653E-8
12/WSW	Maximum (D/Q) Garden	1.1	9.580E-6	9.508E-6	8.283E-6	1.580E-8
15/NW	Maximum (D/Q) Dairy	1.8	1.898E-6	1.871E-6	1.578E-6	3.018E-9
15/NW	Maximum (D/Q) Meat Producer	1.8	1.898E-6	1.871E-6	1.578E-6	3.018E-9
NE	Riverlands / EIC	0.7	4.465E-6	4.450E-6	3.986E-6	2.159E-8
WSW	Tower's Club	0.5	2.528E-5	2.521E-5	2.309E-5	4.789E-8

NEAREST RESIDENCE WITHIN A 5-MILE RADIUS OF SSES BY SECTOR

SECTOR NUMBER	AFFECTED SECTOR	MILES	X/Q	X/Q DEC	X/Q DEC+DEP	DEPOSITION
1	N	1.3	1.822E-6	1.807E-6	1.557E-6	4.102E-9
2	NNE	1.0	3.328E-6	3.309E-6	2.897E-6	1.007E-8
3	NE	0.9	3.111E-6	3.098E-6	2.729E-6	1.417E-8
4	ENE	2.1	5.555E-7	5.516E-7	4.565E-7	3.537E-9
5	E	1.4	4.277E-7	4.257E-7	3.641E-7	2.958E-9
6	ESE	0.5	1.715E-6	1.712E-6	1.566E-6	1.370E-8
7	SE	0.5	1.713E-6	1.711E-6	1.565E-6	1.406E-8
8	SSE	0.6	2.053E-6	2.049E-6	1.852E-6	1.653E-8
9	S	1.0	1.254E-6	1.249E-6	1.092E-6	7.811E-9
10	SSW	0.9	2.811E-6	2.798E-6	2.466E-6	1.123E-8
11	SW	1.5	2.360E-6	2.340E-6	1.997E-6	5.578E-9
12	WSW	1.1	9.580E-6	9.508E-6	8.283E-6	1.580E-8
13	W	1.2	8.152E-6	8.079E-6	7.004E-6	1.090E-8
14	WNW	0.8	8.368E-6	8.308E-6	7.393E-6	1.357E-8
15	NW	0.8	6.775E-6	6.726E-6	5.986E-6	1.265E-8
16	NNW	0.6	6.674E-6	6.642E-6	6.017E-6	1.496E-8

NEAREST GARDEN WITHIN A 5-MILE RADIUS OF SSES BY SECTOR

SECTOR NUMBER	AFFECTED SECTOR	MILES	X/Q	X/Q DEC	X/Q DEC+DEP	DEPOSITION
1	N	3.2	4.871E-7	4.774E-7	3.808E-7	9.227E-10
2	NNE	2.3	1.002E-6	9.896E-7	8.154E-7	2.644E-9
3	NE	2.3	8.163E-7	8.083E-7	6.649E-7	3.228E-9
4	ENE	3.6	2.446E-7	2.416E-7	1.888E-7	1.403E-9
5	E	1.8	2.875E-7	2.858E-7	2.396E-7	1.962E-9
6	ESE	2.5	1.164E-7	1.154E-7	9.414E-8	7.363E-10
7	SE	0.6	1.313E-6	1.310E-6	1.184E-6	1.034E-8
8	SSE	1.5	4.768E-7	4.748E-7	4.040E-7	3.117E-9
9	S	1.1	1.078E-6	1.073E-6	9.326E-7	6.569E-9
10	SSW	1.2	1.810E-6	1.799E-6	1.556E-6	6.763E-9
11	SW	1.9	1.643E-6	1.625E-6	1.361E-6	3.806E-9
12	WSW	1.1	9.580E-6	9.508E-6	8.283E-6	1.580E-8
13	W	1.2	8.152E-6	8.079E-6	7.004E-6	1.090E-8
14	WNW	1.3	3.821E-6	3.781E-6	3.263E-6	5.596E-9
15	NW	1.8	1.898E-6	1.871E-6	1.578E-6	3.018E-9
16	NNW	4.0	3.876E-7	3.765E-7	2.938E-7	5.541E-10

**TABLE 3-8
(continued)**

**NEAREST ANIMAL RAISED FOR MEAT CONSUMPTION
WITHIN A 5-MILE RADIUS OF SSES BY SECTOR**

SECTOR NUMBER	AFFECTED SECTOR	MILES	X/Q	X/Q DEC	X/Q DEC+DEP	DEPOSITION
2	NNE	2.3	1.002E-6	9.896E-7	8.154E-7	2.644E-9
10	SSW	3.0	4.062E-7	4.006E-7	3.207E-7	1.319E-9
		3.1	3.776E-7	3.722E-7	2.969E-7	1.213E-9
		3.5	2.849E-7	2.803E-7	2.205E-7	8.771E-10
		3.8	2.423E-7	2.380E-7	1.855E-7	7.246E-10
13	W	5.0	7.489E-7	7.226E-7	5.499E-7	6.292E-10
15	NW	1.8	1.898E-6	1.871E-6	1.578E-6	3.018E-9
16	NNW	4.2	3.631E-7	3.522E-7	2.734E-7	5.091E-10

ALL DAIRY LOCATIONS NEAR SSES

SECTOR NUMBER	AFFECTED SECTOR	MILES	X/Q	X/Q DEC	X/Q DEC+DEP	DEPOSITION
5	E	4.5	5.910E-8	5.821E-8	4.429E-8	3.424E-10
6	ESE	2.7	1.004E-7	9.949E-8	8.043E-8	6.214E-10
		4.1	4.271E-8	4.211E-8	3.240E-8	2.348E-10
		4.2	4.047E-8	3.989E-8	3.061E-8	2.210E-10
7	SE	2.6	1.284E-7	1.275E-7	1.034E-7	8.185E-10
10	SSW	3.0	4.062E-7	4.006E-7	3.207E-7	1.319E-9
		3.1	3.776E-7	3.722E-7	2.969E-7	1.213E-9
		3.5	2.849E-7	2.803E-7	2.205E-7	8.771E-10
		3.8	2.423E-7	2.380E-7	1.855E-7	7.246E-10
		14.0	2.242E-8	2.096E-8	1.393E-8	4.681E-11
13	W	5.0	7.489E-7	7.226E-7	5.499E-7	6.292E-10
15	NW	1.8	1.898E-6	1.871E-6	1.578E-6	3.018E-9
16	NNW	4.2	3.631E-7	3.522E-7	2.734E-7	5.091E-10

X/Q	RELATIVE CONCENTRATION (SEC/M ³)
X/Q DEC	DECAYED AND UNDEPLETED, HALF-LIFE 2.26 DAYS (SEC/M ³)
X/Q DEC+DEP	DECAYED AND DEPLETED, HALF-LIFE 8 DAYS (SEC/M ³)
DEPOSITION	RELATIVE DEPOSITION RATE (1/M ²)

SSES 2000 ANNUAL WIND ROSE
60M LEVEL - PRIMARY TOWER

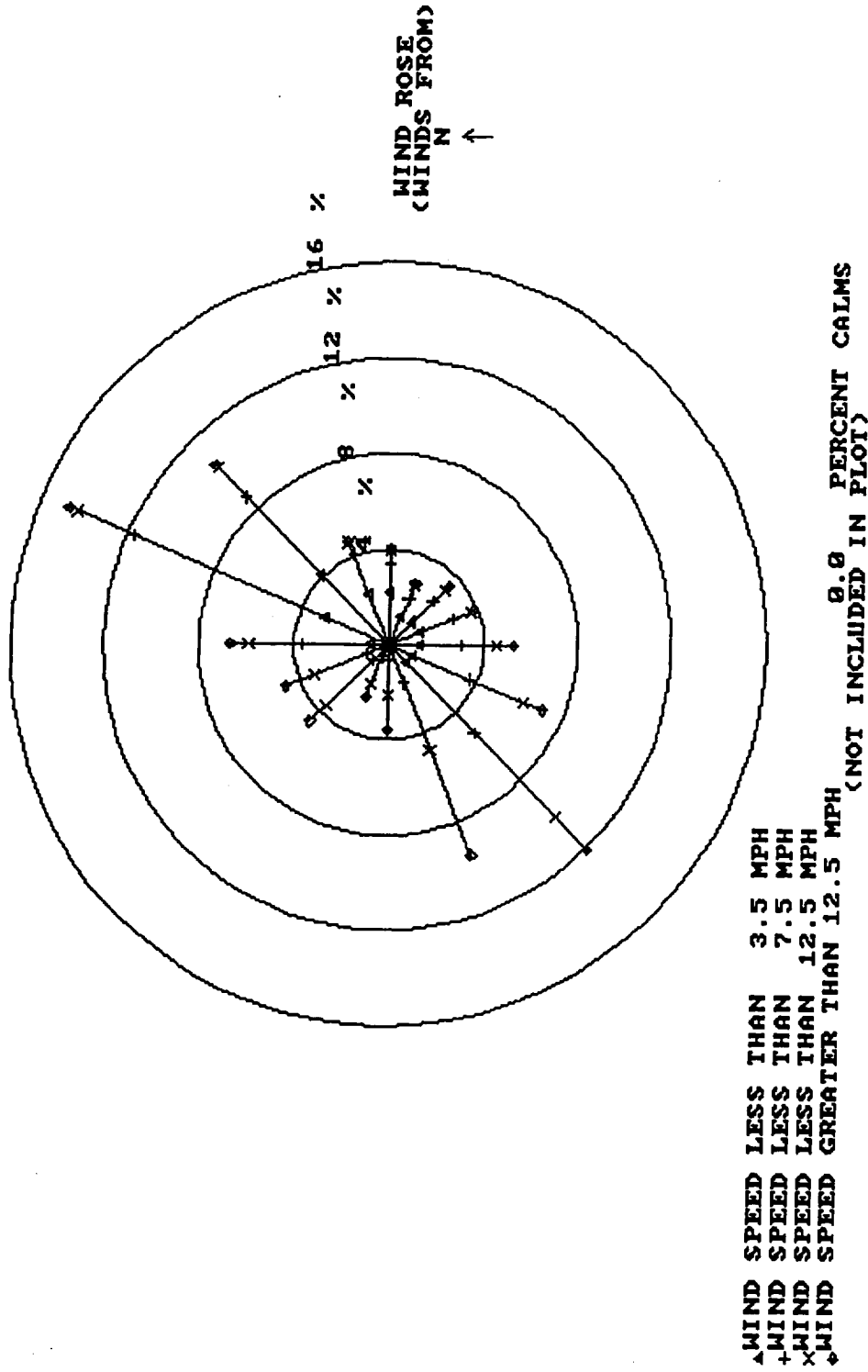

FIGURE 3-1

This wind rose displays the frequency of hourly average wind direction from a given sector. In 2000, the predominant wind direction occurred 14.7% of the time from the NNE sector. The average wind speed was 7.6 mph. The peak sector wind speed was 12.6 mph from the WSW.

SSES 2000 ANNUAL WIND ROSE
 10M LEVEL - PRIMARY TOWER

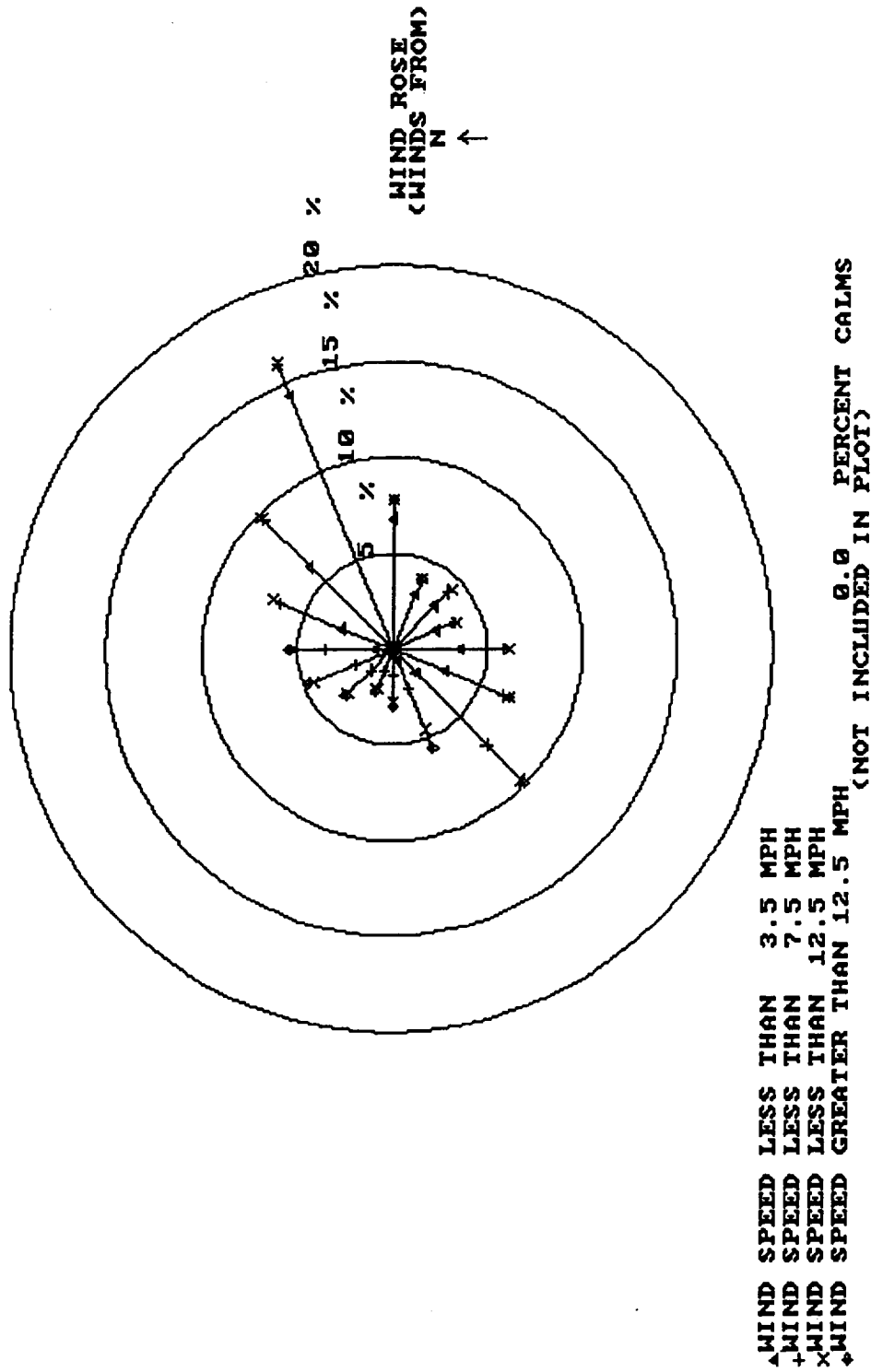

FIGURE 3-2

This wind rose displays the frequency of hourly average wind direction from a given sector. In 2000, the predominant wind direction occurred 16.1% of the time from the ENE sector. The average wind speed was 4.6 mph. The peak sector wind speed was 8.8 mph from the WSW.

Figure 3-3

SSES Pasquil Stability Class Prevalences Data Period: 2000

SSES Joint Frequency Distributions at 10 Meters
Wind Speed and Direction 10M vs. Delta Temperature 60-10M
(Based on 8720 Valid Hours)

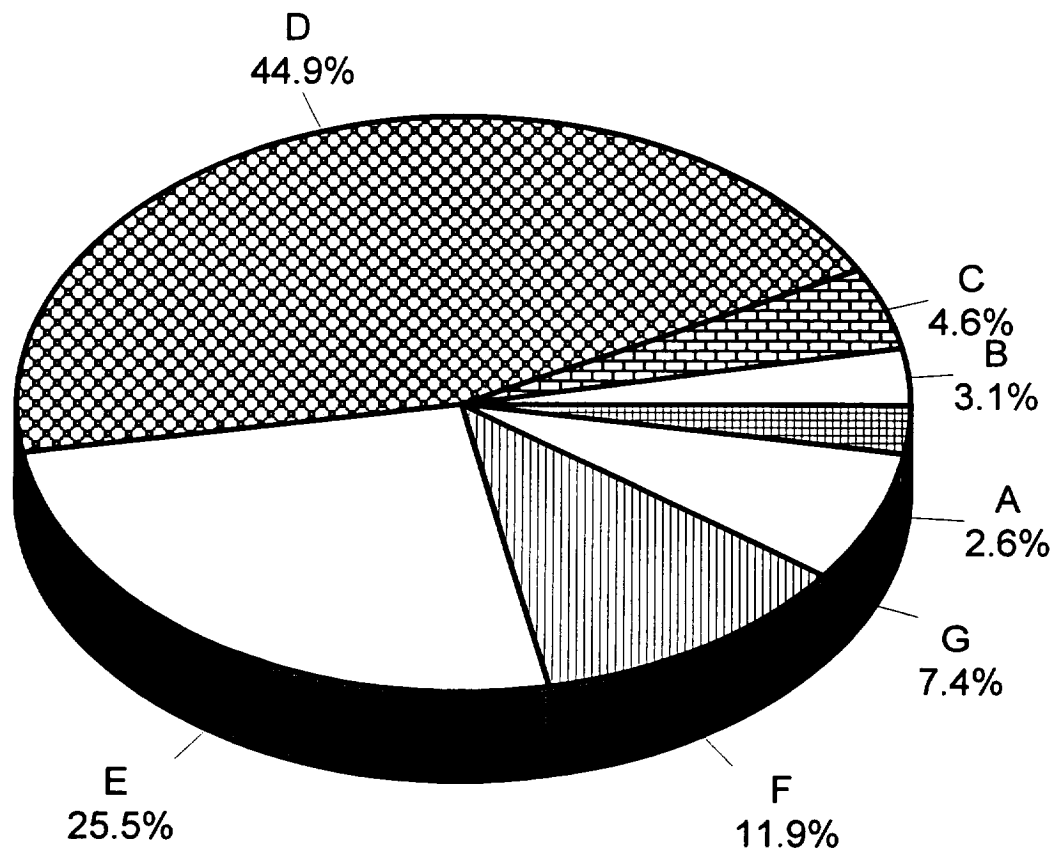

SECTION 4
DOSE MEASUREMENTS AND ASSESSMENTS

Radiological Impact on Man

Sampling and analysis of airborne and waterborne effluents were performed in accordance with the frequencies, types of analysis, and Lower Limit of Detection (LLD) outlined in the SSES Technical Requirements.

Radioactive material was detected in some of the airborne and waterborne effluent samples analyzed. Dose calculations using measured effluent activity levels, meteorological data from the current reporting period and average river flow dilution factors resulted in estimated doses to individuals at levels below 10 CFR 20 and 10 CFR 50, Appendix I limits. Direct radiation resulting from plant operation, as measured by environmental thermoluminescent dosimeters located around the plant contributed a maximum of 2.85E-2 mrem (measured at TLD Location 9S2) at the Protected Area Boundary south of the plant. The maximum organ/total body dose including thyroid from all airborne effluent is 1.37E-1 mrem (child lung, Table 4-4). The maximum organ/total body dose from liquid effluent is 7.08E-3 mrem (adult GI-LLI: two times the unit dose shown Table 4-2). Conservatively adding the maximum total body/organ dose from liquid and gaseous effluent (even though different age groups) and the maximum total body dose determined from direct radiation bounds the dose that any member of the public receives from operation of SSES. The result (1.73E-1 mrem) is 0.7% of the 40CFR190 limit of 25 mrem to total body/organ (except thyroid) and 0.2% of the 40CFR190 limit of 75 mrem to the thyroid.

Doses to a maximally exposed member of the public from waterborne effluents are calculated for fish ingestion and shoreline exposure at the plant outfall, and drinking water ingestion at Danville, PA. Site specific parameters used in the calculations for the Danville receiver, specific for actual average blowdown and river level for the entire year, are shown in Table 4-1.

TABLE 4-1

**SITE-SPECIFIC PARAMETERS USED FOR LADTAP II CALCULATIONS
(DANVILLE RECEIVER)
FOR 2000**

PARAMETER	ENTIRE YEAR
Cooling Tower Blowdown (CFS)	17.6
Average Net River Level (ft.)	7.2
Dilution Factor at Danville ⁽¹⁾	509.2
Transit time to Danville (hr.) ⁽¹⁾	21.8

⁽¹⁾From ODCM-QA-005, Att. D

Summaries of maximum individual doses resulting from airborne and waterborne radioactive effluent releases are given in Table 4-2. Meteorological data from Section 3 were used to calculate the dose from airborne effluents.

Technical Specifications 5.5.4 require assessment of radiation doses from radioactive airborne and waterborne effluent to members of the public within the site boundary. There are no significant exposure pathways from waterborne effluents in these areas. Onsite doses are assessed relative to offsite dose values and are adjusted for appropriate dispersion and occupancy factors. Summaries of the calculated maximum doses within the site boundary and selected locations resulting from airborne effluents are presented in Tables 4-3 through 4-4.

SSES Technical Specification 5.5.4 requires that the Annual Effluent Release Reports include an assessment of the radiation dose from radioactive effluents to members of the public within the site boundary. Within the SSES Site Boundary there are several areas frequented by members of the public. The SSES Riverlands Energy Information Center is a representative nearby location visited by members of the public. Doses from airborne effluent are calculated for members of the public for this location. The Riverlands, selected residences within the Site Boundary, and the maximum site boundary location for which dose calculations are performed are shown in Figure 4-1.

In the area comprising the Riverlands recreation area, which surrounds the Energy Information Center, three pathways of radiation exposure can be identified: plume, ground, and inhalation. There are no significant exposure pathways from waterborne effluents in this area. There are approximately 100,000 visitors to the Riverlands/Information Center complex each year. For dose calculations, it is assumed the visitor stays in the area for one hour.

Use of the GASPAR code yields calculated doses for the Riverlands area for the report period. These doses are the total doses at the location from gaseous effluents during the report period. In order to compute doses to members of the public who stay for only short periods of time, these doses are converted to dose rates which are averages for the entire year. Taking into account the estimated 100,000 person-hours of occupancy, the collective (person-rem) doses shown in Table 4-3 are calculated.

TABLE 4-2

**SUMMARY OF MAXIMUM INDIVIDUAL DOSES
TO MEMBERS OF THE PUBLIC
DATA PERIOD: 1/1/00 TO 12/31/00**

EFFLUENT	AGE GROUP	APPLICABLE ORGAN	ESTIMATED MAXIMUM DOSE (MREM)	LOCATION		PERCENT OF LIMIT	LIMIT (MREM) ⁽²⁾
				DIST (MILES)	AFFECTED SECTOR		
Liquid ⁽¹⁾	Teen	Total Body	1.34E-3	(3)		0.04	3
Liquid ⁽¹⁾	Adult	GI-LLI	3.54E-3	(3)		0.04	10
Noble Gas	N/A	Air Dose (Gamma-MRAD)	0	N/A	N/A	0	10
Noble Gas	N/A	Air Dose (Beta-MRAD)	0	N/A	N/A	0	20
Airborne Iodine and Particulates ⁽⁴⁾	Child	Lung	1.37E-1	1.10	WSW	0.9	15

⁽¹⁾Estimated dose is based on a site total activity release equally divided between Unit 1 and Unit 2.

⁽²⁾10 CFR 50, Appendix I limits are in terms of mrad or mrem/reactor-year for airborne effluent and mrem per year for waterborne effluent from each unit.

⁽³⁾Doses from liquid effluent are estimated from fish ingestion and shoreline exposure at the site outfall and from the drinking water pathway at Danville, PA.

⁽⁴⁾Estimated dose is based on the site total activity release.

TABLE 4-3

**CALCULATED COLLECTIVE DOSES TO MEMBERS OF THE PUBLIC WITHIN THE
RIVERLANDS/INFORMATION CENTER COMPLEX
DATA PERIOD: 1/1/00 TO 12/31/00**

EFFLUENT	AGE GROUP	APPLICABLE ORGAN	DOSE RATE⁽¹⁾ (MREM/HR)	COLLECTIVE DOSE⁽²⁾ (PERSON-REM)
Noble Gas	N/A	Total Body	0	0
Noble Gas	N/A	Skin	0	0
Iodine and Particulates	Teen	Skin	2.35E-6	2.35E-4

⁽¹⁾Estimated dose rate is based on annual site total activity release (Table 4-4).

⁽²⁾Collective dose is based on occupancy of 100,000 person-hours.

TABLE 4-4

SUMMARY OF MAXIMUM INDIVIDUAL DOSES FROM AIRBORNE EFFLUENT

LOCATION	PATHWAY	MAXIMUM TOTAL BODY DOSE (MREM)	MAXIMUM ORGAN DOSE (MREM)	MAXIMUM THYROID DOSE (MREM)
Maximum X/Q site boundary	Plume	0.0	0.0	0.0
	Ground	3.83E-3	3.83E-3	3.83E-3
	Inhalation	4.68E-2	4.79E-2	4.68E-2
	Total	5.07E-2 (teen)	5.17E-2 (teen lung)	5.07E-2 (teen)
Maximum X/Q Residence and Maximum D/Q Garden	Plume	0.0	0.0	0.0
	Ground	2.89E-3	2.89E-3	2.89E-3
	Vegetable	1.02E-1	1.01E-1	1.01E-1
	Inhalation	3.25E-2	3.31E-2	3.25E-2
Total	1.37E-1 (child)	1.37E-1 (child lung)	1.37E-1 (child)	
Maximum D/Q Dairy and Meat Producer	Plume	0.0	0.0	0.0
	Ground	5.53E-4	5.53E-4	5.53E-4
	Vegetable	2.01E-2	2.01E-2	2.01E-2
	Meat	1.23E-3	1.22E-3	1.22E-3
	Cow Milk	8.21E-3	8.21E-3	8.22E-3
	Inhalation	6.44E-3	6.56E-3	6.45E-3
Total	3.66E-2 (child)	3.66E-2 (child lung)	3.65E-2 (child)	
Towers Club	Plume	0.0	0.0	0.0
	Ground	8.74E-3	8.74E-3	8.74E-3
	Inhalation	9.70E-2	9.92E-2	9.70E-2
	Total	1.06E-1 (teen)	1.08E-1 (teen lung)	1.06E-1 (teen)
Riverlands EIC	Plume	0.0	0.0	0.0
	Ground	3.94E-3	4.64E-3	3.94E-3
	Inhalation	1.71E-2	1.71E-2	1.71E-2
	Total	2.11E-2 (teen)	2.18E-2 (teen skin)	2.11E-2 (teen)

Note: The doses shown above are based on 100% occupancy at the indicated locations.

FIGURE 4-1

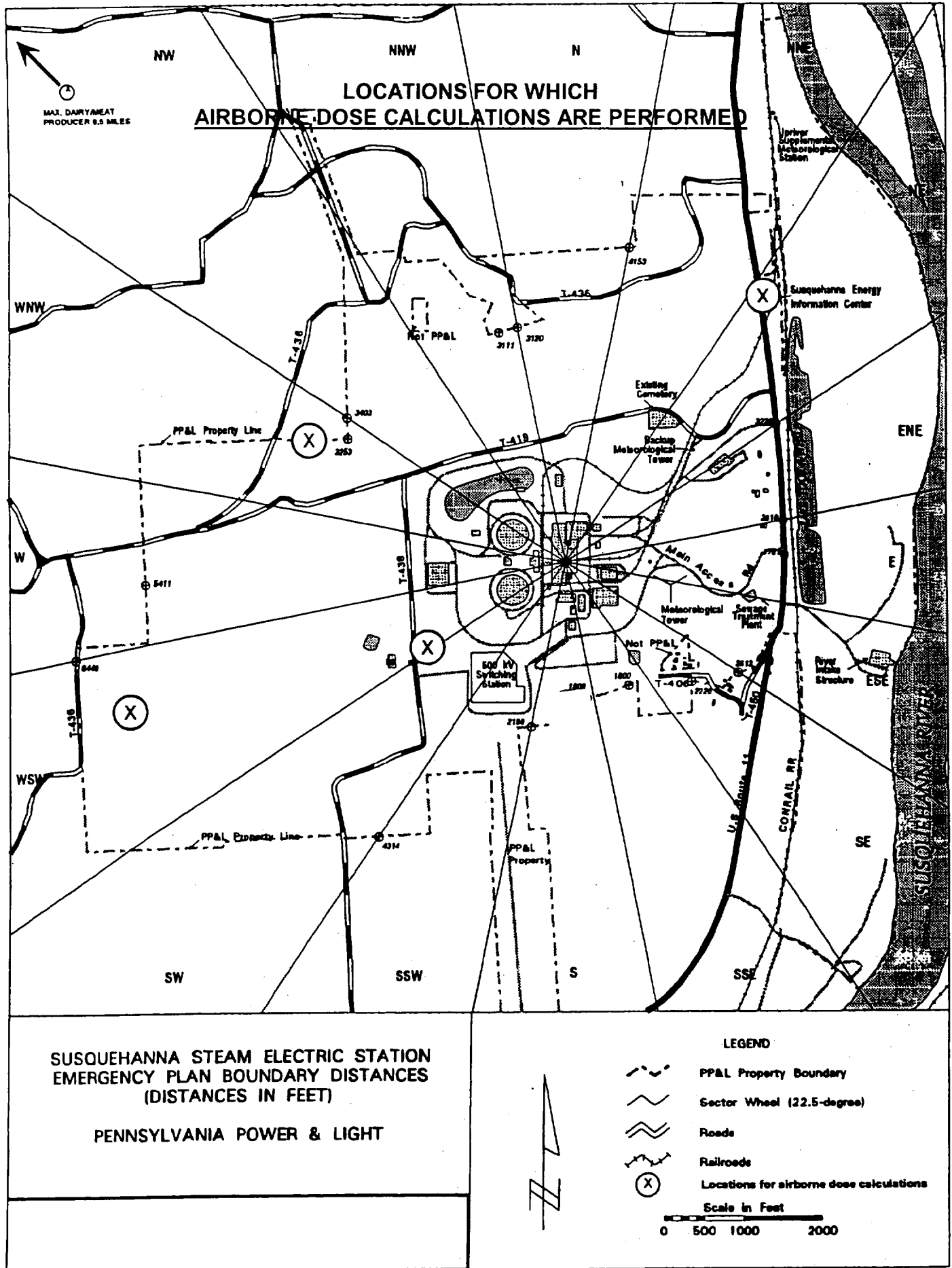

SECTION 5

**CHANGES TO THE OFFSITE DOSE CALCULATION MANUAL
AND THE SOLID RADIOACTIVE WASTE PROCESS CONTROL PROGRAM**

CHANGES TO THE OFFSITE DOSE CALCULATION MANUAL

Three ODCM sections were revised in 2000. ODCM-QA-002, ODCM Review and Revision Control, was revised to reflect responsibilities of the Supervisor – Environmental Services, to allow tracking of changes by various PPL tracking mechanisms, and to explicitly include revision control requirements of Technical Specification 5.5.1.C.3.

ODCM-QA-004, Airborne Effluent Dose Calculations, added the grass-to-meat-to-man airborne pathway to be consistent with TR B 3.11.2.3 and added the requirement to include Insignificant Effluent Pathways in surveillances. Editorial changes were also made.

ODCM-QA-008, Radiological Environmental Monitoring Program, was revised to conform with the discussion of TR B 3.11.4.1 concerning verification of compliance with TRS 3.11.4.1.2 for REMP sampling analyses.

These changes have not reduced the level of effluent control and have not impacted the accuracy or reliability of effluent dose or setpoint controls.

A copy of the ODCM is provided in Appendix A.

**CHANGES TO THE
SOLID RADIOACTIVE WASTE PROCESS CONTROL PROGRAM**

There were no changes to the Solid Radioactive Waste Process Control Program, NDAP-QA-0646 during the report period (2000).

SECTION 6

**REPORTS OF EXCEPTION TO THE SSES
EFFLUENT MONITORING PROGRAM**

**REPORTS OF EXCEPTION TO THE SSES
EFFLUENT MONITORING PROGRAM**

No events have been determined to be reportable under any Technical Requirement for the period of 2000.

SECTION 7

**CORRECTIONS TO DOSES REPORTED IN PREVIOUS
SEMIANNUAL OR ANNUAL EFFLUENT AND WASTE DISPOSAL REPORT**

CORRECTIONS TO DOSES REPORTED IN PREVIOUS SEMIANNUAL OR ANNUAL EFFLUENT AND WASTE DISPOSAL REPORTS

Tables 2 through 5 of the 1999 Annual Effluent and Waste Disposal Report erroneously stated that the activity values for composited samples (P-32, Sr-89, Sr-90, and Fe-55) reported for the fourth quarter were established based on third quarter sample analyses and fourth quarter discharge volumes. The reported activities, in fact, are based on the fourth quarter sample analyses. Thus, the activities and the resulting computed doses reported in the 1999 report do not have to be updated.

SECTION 8

**EFFLUENT FROM SYSTEMS CLASSIFIED AS
INSIGNIFICANT EFFLUENT PATHWAYS**

EFFLUENT FROM SYSTEMS CLASSIFIED AS INSIGNIFICANT EFFLUENT PATHWAYS

Systems classified as Insignificant Effluent Pathways are evaporation from the Unit 1 and Unit 2 Condensate Storage Tanks (CSTs) and the common Refueling Water Storage Tank (RWST) and from the Hydrogen Seal Oil and the Main Turbine and RFPT lubrication oil mist eliminators which vent to the turbine building roofs. There are no waterborne effluent pathways classified as insignificant.

These pathways are not continuously monitored. The CSTs and RWST are sampled quarterly to determine the concentration of radionuclides present in these tanks. Airborne release to the environment from the tanks is estimated based on conservative estimates of the evaporation rates from each of the tanks using a modified method established within Chapter 7 of EPA AP-42. A conservative carry-over fraction of radionuclides from the water to the evaporated liquid is then assumed. Airborne release to the environment from the demisters conservatively assumes the maximum contamination of the oil by condensate (1000 ppm) as it passes through the turbines followed by immediate removal of 100% of the water by the oil mist eliminators. The annual release of tritium and, iodines, and particulates with half-lives greater than 8 days was calculated based on these conservative assumptions; the calculated releases are shown in Table 8-1. All nuclides are negligible compared to the airborne release shown in Tables 2-1 and 2-2 except for tritium. The maximum dose to the public from a release of 23.2 Ci of tritium is calculated to be 3.3E-2 mrem (child). This is a fraction of the maximum dose from airborne effluent reported in Section 4 and is insignificant compared to the annual dose limits.

The CST analyses showed concentrations ranging from 3.8E-8 to 9.3E-7 $\mu\text{Ci/ml}$ of Xe-133 and Xe-135. This range of concentration of dissolved and entrained noble gas in water stored in tanks on site is less than 0.5% of the Technical Requirement limit of 2E-4 $\mu\text{Ci/ml}$ allowed in water that may be discharged to the environment. Thus, the release of noble gas from these pathways will not be considered further.

TABLE 8-1

**ANNUAL RELEASE FROM SYSTEMS CLASSIFIED AS
INSIGNIFICANT EFFLUENT PATHWAYS**

	RWST (Ci)	U1-CST and Main Turbine/RFP Lube Oil Systems (Ci)	U2-CST and Main Turbine/RFP Lube Oil Systems (Ci)	Total (Ci)
H-3	4.26E-2	1.01E+01	1.30E+01	2.32E+01
Mn-54	4.3E-7	7.47E-07	4.94E-07	1.67E-06
Co-58		3.53E-08		3.53E-08
Fe-59	1.1E-9	1.07E-08		1.18E-08
Co-60	1.4E-7	4.26E-07	1.41E-07	7.07E-07
Tc-99m			1.95E-08	1.95E-08
Sb-125		2.81E-08		2.81E-08
Cs-137	5.4E-11			5.4E-11