

ENERGY NORTHWEST

P.O. Box 968 ■ Richland, Washington 99352-0968

February 22, 2001
GO2-01-030

Docket No. 50-397

U.S. Nuclear Regulatory Commission
Attn: Document Control Desk
Washington, DC 20555

Gentlemen:

Subject: **COLUMBIA GENERATING STATION, OPERATING LICENSE NPF-21
RADIOACTIVE EFFLUENT RELEASE REPORT
FOR JANUARY THROUGH DECEMBER 2000**

In accordance with 10 CFR 50.36a(a)(2) and WNP-2 Technical Specification 5.6.3, the annual Radioactive Effluent Release Report is hereby submitted as an enclosure to this letter. As required by the Technical Specification, the report includes a summary of the quantities of radioactive liquid and gaseous effluents and solid waste released from Columbia Generating Station during the reporting period.

A complete copy of the Columbia Generating Station Offsite Dose Calculation Manual (ODCM) is also enclosed with this submittal as required by Technical Specification 5.5.1. This copy of the ODCM includes revisions made to the document since the last submittal.

Respectfully,



G.O. Smith
Vice President, Generation
Mail Drop 988V

Enclosures

cc: EW Merschoff - NRC RIV	DJ Ross - EFSEC (w/o ODCM)
JS Cushing - NRC NRR	D McBaugh - Dept. of Health
NRC Sr. Resident Inspector - 988C	T Wolff - ANI (w/o ODCM)
DL Williams - BPA/1399	RL Dirkes - PNNL (w/o ODCM)
AW Conklin - Dept. of Health	TC Poindexter - Winston & Strawn (w/o ODCM)
K Rhoads - PNNL (w/o ODCM)	

Jey8

ENERGY NORTHWEST

Columbia Generating Station Radioactive Effluent Release Report

January through December 2000

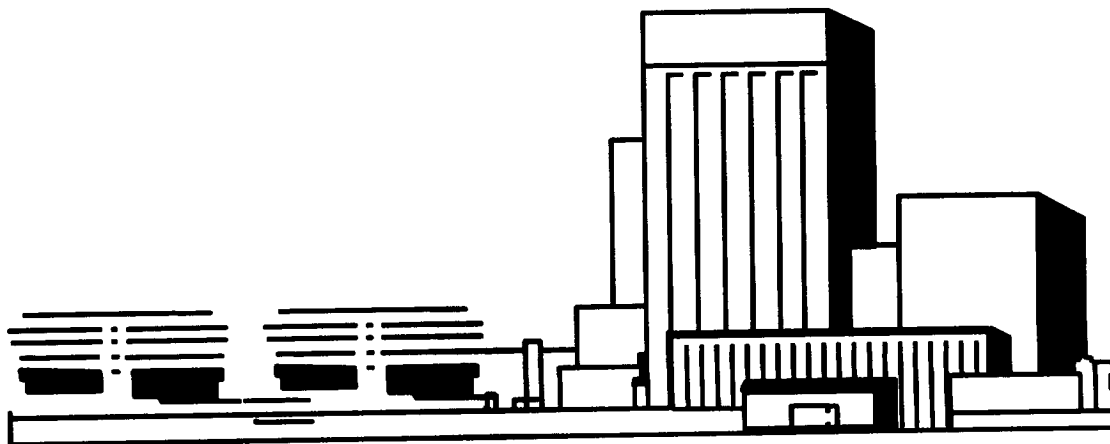

REFERENCE:
10CFR50.36a(a)(2)

Columbia Generating Station
Radioactive Effluent Release Report

January through December 2000

Energy Northwest

License No. NPF-21

Table of Contents

1.0 INTRODUCTION.....	1
2.0 LIQUID EFFLUENTS.....	1
3.0 GASEOUS EFFLUENTS.....	1
EFFLUENT TABLES.....	3
Liquid Effluent Tables.....	3
Table 2-0 10 CFR Part 50 Appendix I Dose Compliance	3
Table 2-1 Summation of Releases	4
Table 2-2 Source Terms	5
Table 2-3 Lower Limits of Detection	6
Gaseous Effluent Tables.....	7
Table 3-0 10 CFR Part 50 Appendix I Dose Compliance	7
Table 3-1 Main Plant Vent Releases	8
Table 3-2 Turbine Building Releases	10
Table 3-3 Radwaste Building Releases	12
Table 3-4 Summation of Releases	14
Table 3-5 Gaseous Batch Releases.....	14
Table 3-6 Lower Limits of Detection	15
4.0 SOLID RADWASTE.....	17
Information required by Columbia Generating Station Offsite Dose Calculation Manual.....	17
Class A.....	17
Class B.....	18
Class C.....	18
Information required by Reg. Guide 1.21.....	19
Solid waste shipped offsite for burial or disposal (not irradiated fuel)	19
Irradiated Fuel Shipments (Disposition).....	21
5.0 METEOROLOGY.....	22
Joint Frequency Distribution Tables.....	23
Table 5-1 1st Quarter 2000, 33 FT AGL.....	23
Table 5-2 1st Quarter 2000, 245 FT AGL.....	26
Table 5-3 2nd Quarter 2000, 33 FT AGL	29
Table 5-4 2nd Quarter 2000, 245 FT AGL	32
Table 5-5 3rd Quarter 2000, 33 FT AGL	35
Table 5-6 3rd Quarter 2000, 245 FT AGL	38
Table 5-7 4th Quarter 2000, 33 FT AGL	41
Table 5-8 4th Quarter 2000, 245 FT AGL	44
Table 5-9 Year 2000, 33 FT AGL.....	47
Table 5-10 Year 2000, 245 FT AGL	50

6.0 DOSE ASSESSMENT -- IMPACT ON MAN	53
Dose Tables.....	54
Table 6-1 Maximum Individual Dose from Liquid Effluents	54
Table 6-2 Average Individual Dose from Liquid Effluents	56
Table 6-3 50-Mile Population Collective Dose from Liquid Effluents	57
Table 6-4 Annual Collective Dose from Liquid Effluents.....	58
Table 6-5 Summary of Dose from Gaseous Effluents	59
Table 6-6 50-Mile Population Dose from Gaseous Effluents.....	61
7.0 REVISIONS TO THE ODCM.....	62
8.0 REVISIONS TO THE PROCESS CONTROL PROGRAM (PCP)	62
9.0 NEW OR DELETED LOCATIONS FOR DOSE ASSESSMENTS AND/OR ENVIRONMENTAL MONITORING LOCATIONS.....	62
10.0 MAJOR CHANGES TO RADIOACTIVE LIQUID, GASEOUS AND SOLID WASTE TREATMENT SYSTEMS	62

1.0 Introduction

This report is submitted in compliance with 10CFR50.36a(a)(2) and Technical Specification 5.6.3. It includes a summary of the quantities of radioactive liquid and gaseous effluents and solid radwaste released from Columbia Generating Station during calendar year 2000. Effluent data is summarized on a quarterly basis.

2.0 Liquid Effluents

No radioactive liquids were discharged from Columbia Generating Station during calendar year 2000 (See Tables 2-0 through 2-3).

The average flow rate of the Columbia River from January through December 2000 was $1.20E+05$ cubic feet per second.

There were no abnormal releases.

3.0 Gaseous Effluents

The gaseous radwaste effluents from Columbia Generating Station were released from three (3) release points:

- Main Plant Vent -- mixed mode release
- Turbine Building -- ground level release
- Radwaste Building -- ground level release

The gaseous source terms from each release point are listed in Tables 3-1, 3-2, and 3-3. Table 3-4 provides a summation of the total activity released, the average release rate, the percentage of ODCM Requirement For Operability limit, gross alpha radioactivity and the estimated total error associated with the measurements of radioactivity in the gaseous effluents.

Radioactivity measurements for gaseous effluent releases are performed for fission and activation gases by collecting the samples in a marinelli beaker and analyzing them using gamma spectroscopy. Air is analyzed for tritium by collection of water vapor on a desiccant with subsequent distillation and liquid scintillation counting. Particulates and iodines are sampled using particulate filters and charcoal cartridges. Both are analyzed using gamma spectroscopy. The average energy per disintegration of fission and activation gases is not included in this report as it is not required by Technical Specifications and is not used for gaseous effluent release rate limit calculations.

Noble gas activities are commonly below detection limits in the building effluent ducts. When no radioactive noble gas was detected in an effluent duct, a value of zero was used for release and dose calculations.

Calculations were performed for releases using the NRC GASPAR II computer program and parameters as outlined in the ODCM. Quarterly doses to a member of the

public were determined at the locations identified in the annual land use census and at the site boundary.

Table 3-0 summarizes the results of these calculations.

Total error estimates are propagated from individual error estimates of sample volume, sample activity and effluent flow rate measurements. The overriding uncertainty in all cases is in the measurement of the effluent activity and sample volumes. The estimated error was determined to be 36 percent at the 95 percent confidence level.

The percent of ODCM limit for fission and activation gases (air dose) was determined for locations identified in the annual land use census, and was based on quarterly limits of ten (10) millirads for beta and five (5) millirads for gamma. These locations were used to determine the most restrictive value to be used in Table 3-4 for each quarter.

The ODCM limits are listed in Table 3-0.

In addition to the reactor facility, a backup chemistry laboratory is located within the Emergency Operations Facility (EOF) approximately 0.75 miles from the reactor building. The radiochemical hood within the backup chemistry lab contains HEPA filters and is monitored for radioactive releases when in operation. Gamma spectrometry indicated no radioactive materials present other than that attributable to natural background. The laundry facility described in previous effluent reports has been dismantled and the ventilation system removed.

There were no abnormal releases of gaseous effluent during this reporting period.

Problem Evaluation Request (PER) 200-1361 documented a problem with the repair of the low range Reactor Building Stack Monitor (PRM-RE-1A). The monitor was declared inoperable from July 22, 2000 to August 26, 2000 and required replacement of the cryostat, compressor, and detector. A variety of delays were encountered in troubleshooting, scheduling and executing repairs. Delays were attributed to a combination of manpower, spare parts, and measuring instrument availability, and the time required for cryogenic cool down when performing testing. An action has been initiated to evaluate different detectors that do not require cryogenic cooling.

Effluent Tables

Liquid Effluent Tables

Table 2-0 10 CFR Part 50 Appendix I Dose Compliance

Liquid Effluents

Report Period: January -- December 2000

	1st Quarter	2nd Quarter	3rd Quarter	4th Quarter	Year
Number of Batch Releases	0.00E+00	0.00E+00	0.00E+00	0.00E+00	0.00E+00

Discharge Duration in Hours

Total	0.00E+00	0.00E+00	0.00E+00	0.00E+00	0.00E+00
Average	0.00E+00	0.00E+00	0.00E+00	0.00E+00	0.00E+00
Minimum	0.00E+00	0.00E+00	0.00E+00	0.00E+00	0.00E+00
Maximum	0.00E+00	0.00E+00	0.00E+00	0.00E+00	0.00E+00

Dilution Flow

Gallons	0.00E+00	0.00E+00	0.00E+00	0.00E+00	0.00E+00
---------	----------	----------	----------	----------	----------

Maximum Individual Dose (mrem)

Whole Body (Adult)	0.00E+00	0.00E+00	0.00E+00	0.00E+00	0.00E+00
ODCM Limit	1.5	1.5	1.5	1.5	3.0
% of Limit	0.00E+00	0.00E+00	0.00E+00	0.00E+00	0.00E+00
Organ	0.00E+00	0.00E+00	0.00E+00	0.00E+00	0.00E+00
ODCM Limit	5	5	5	5	10
% of Limit	0.00E+00	0.00E+00	0.00E+00	0.00E+00	0.00E+00

ODCM Limits

Batch	Less than the concentration specified in 10 CFR 20, Appendix B, Table II, Column 2, and less than 2.0E-04 microcuries/ml dissolved or entrained noble gases.
Calendar Quarter	Less than or equal to 1.5 mrem to the total body, and less than or equal to 5 mrem to any organ.
Calendar Year	Less than or equal to 3 mrem to the total body, and less than or equal to 10 mrem to any organ.

**Table 2-1 Summation of Releases
Liquid Effluents**

Report Period: January -- December 2000

1st Quarter	2nd Quarter	3rd Quarter	4th Quarter	Year	Est. Total Error* %
----------------	----------------	----------------	----------------	------	---------------------------

A. Fission and activation products

Total release (not including tritium, gases, alpha) (Ci)	N/A	N/A	N/A	N/A	0.00E+00	N/A
Average diluted concentration during period (µCi/ml)	N/A	N/A	N/A	N/A	N/A	
Percent of MPC limit (%)	N/A	N/A	N/A	N/A	N/A	

B. Tritium

Total release (Ci)	N/A	N/A	N/A	N/A	0.00E+00	N/A
Average diluted concentration during period (µCi/ml)	N/A	N/A	N/A	N/A	N/A	
Percent of MPC limit (%)	N/A	N/A	N/A	N/A	N/A	

C. Dissolved and entrained gases

Total release (Ci)	N/A	N/A	N/A	N/A	0.00E+00	N/A
Average diluted concentration during period (µCi/ml)	NA	NA	N/A	N/A	N/A	
Percent of limit (%)	NA	NA	N/A	N/A	N/A	

D. Gross alpha radioactivity

Total release (Ci)	N/A	N/A	N/A	N/A	0.00E+00	N/A
--------------------	-----	-----	-----	-----	----------	-----

E. Liquid Waste

Volume of waste prior to dilution (liters)	0.00E+00	0.00E+00	0.00E+00	0.00E+00	0.00E+00	N/A
--	----------	----------	----------	----------	----------	-----

F. Dilution Water

Volume of dilution water used during period (liters)	0.00E+00	0.00E+00	0.00E+00	0.00E+00	0.00E+00	N/A
--	----------	----------	----------	----------	----------	-----

* At 95% confidence level
See Table 2-3 for LLD values.

**Table 2-2 Source Terms
Liquid Effluents**

Report Period: January -- December 2000

Nuclides Released	1st Quarter (Ci)	2nd Quarter (Ci)	3rd Quarter (Ci)	4th Quarter (Ci)	Year (Ci)
-------------------	------------------------	------------------------	------------------------	------------------------	--------------

A. Fission and activation products

strontium-89	N/A	N/A	N/A	N/A	0.00E+00
strontium-90	N/A	N/A	N/A	N/A	0.00E+00
cesium-134	N/A	N/A	N/A	N/A	0.00E+00
cesium-137	N/A	N/A	N/A	N/A	0.00E+00
iodine-131	N/A	N/A	N/A	N/A	0.00E+00
cobalt-58	N/A	N/A	N/A	N/A	0.00E+00
cobalt-60	N/A	N/A	N/A	N/A	0.00E+00
iron-59	N/A	N/A	N/A	N/A	0.00E+00
zinc-65	N/A	N/A	N/A	N/A	0.00E+00
manganese-54	N/A	N/A	N/A	N/A	0.00E+00
chromium-51	N/A	N/A	N/A	N/A	0.00E+00
zirconium-niobium-95	N/A	N/A	N/A	N/A	0.00E+00
molybdenum-99	N/A	N/A	N/A	N/A	0.00E+00
technetium-99m	N/A	N/A	N/A	N/A	0.00E+00
barium-lanthanum-140	N/A	N/A	N/A	N/A	0.00E+00
cerium-141	N/A	N/A	N/A	N/A	0.00E+00
cerium-144	N/A	N/A	N/A	N/A	0.00E+00
iron-55	N/A	N/A	N/A	N/A	0.00E+00
Others					
sodium-24	N/A	N/A	N/A	N/A	0.00E+00
Total for period above*	0.00E+00	0.00E+00	0.00E+00	0.00E+00	0.00E+00

B. Dissolved and entrained gases

xenon-133	N/A	N/A	N/A	N/A	0.00E+00
xenon-135	N/A	N/A	N/A	N/A	0.00E+00

C. Tritium

tritium	N/A	N/A	N/A	N/A	0.00E+00
---------	-----	-----	-----	-----	----------

* Less than (<) values are not included in the totals.

See Table 2-3 for LLD values.

**Table 2-3 Lower Limits of Detection
Liquid Effluents**

Report Period: January -- December 2000

Fission and Activation Products

Nuclide	LLD ($\mu\text{Ci/cc}$)
strontium-89	2.00E-10
strontium-90	3.60E-09
cesium-134	8.60E-09
cesium-137	9.70E-09
barium-lanthanum-140	7.60E-09
molybdenum-99	1.20E-07
cerium-141	6.10E-09
cerium-144	1.00E-07
cobalt-58	2.50E-09
cobalt-60	5.20E-09
iron-59	8.10E-09
chromium-51	4.70E-08
manganese-54	3.40E-09
zinc-65	6.20E-09
iodine-131	6.00E-09
iodine-133	2.10E-09
Others	LLD ($\mu\text{Ci/cc}$)
sodium-24	3.70E-09
copper-64	7.40E-07
antimony-124	8.80E-09
antimony-125	4.30E-08

Dissolved and entrained gases

Nuclide	LLD ($\mu\text{Ci/cc}$)
xenon-133	2.10E-08
xenon-135	5.10E-09

Gaseous Effluent Tables

Table 3-0 10 CFR Part 50 Appendix I Dose Compliance

Report Period: January -- December 2000

1st Quarter	2nd Quarter	3rd Quarter	4th Quarter	Year*
-------------	-------------	-------------	-------------	-------

Noble Gas

Gamma Air Dose (mrad)	3.76E-04	2.21E-04	2.31E-04	3.71E-04	8.37E-04
ODCM Limit (mrad)	5	5	5	5	10
% of Limit	7.52E-03	4.42E-03	4.62E-03	7.42E-03	8.37E-03
Beta Air Dose (mrad)	1.33E-04	7.81E-05	8.14E-05	1.31E-04	2.95E-04
ODCM Limit (mrad)	10	10	10	10	20
% of Limit	1.33E-03	7.81E-04	8.14E-04	1.31E-03	1.48E-03

Iodine-131, Iodine-133, Tritium, and Particulates with half-lives greater than eight days

Organ Dose (mrem)	1.06E-03	6.29E-04	8.56E-04	1.30E-03	3.85E-03
ODCM Limit (mrem)	7.5	7.5	7.5	7.5	15
% of Limit	1.41E-02	8.39E-03	1.14E-02	1.73E-02	2.56E-02

* Rather than the sum of the quarters, these values are based on average annual meteorological parameters and total annual effluents.

**Table 3-1 Main Plant Vent Releases
Fission Gases and Iodines**

Report Period: January -- December 2000

Nuclides Released	1st Quarter (Ci)	2nd Quarter (Ci)	3rd Quarter (Ci)	4th Quarter (Ci)	Year (Ci)
-------------------	------------------------	------------------------	------------------------	------------------------	--------------

A. Fission gases

krypton-85	<LLD	<LLD	<LLD	<LLD	<LLD
krypton-85m	<LLD	<LLD	<LLD	<LLD	<LLD
krypton-87	<LLD	<LLD	<LLD	<LLD	<LLD
krypton-88	<LLD	<LLD	<LLD	<LLD	<LLD
xenon-133	<LLD	<LLD	<LLD	<LLD	<LLD
xenon-133m	<LLD	<LLD	<LLD	<LLD	<LLD
xenon-135	<LLD	<LLD	<LLD	<LLD	<LLD
xenon-135m	<LLD	<LLD	<LLD	<LLD	<LLD
xenon-138	<LLD	<LLD	<LLD	<LLD	<LLD
Others					
argon-41	3.14E+00	3.13E+00	1.91E+00	6.00E+00	1.42E+01
Total fission gases for period *	3.14E+00	3.13E+00	1.91E+00	6.00E+00	1.42E+01

B. Iodines

iodine-131	<LLD	4.45E-05	5.42E-05	<LLD	9.87E-05
iodine-132	<LLD	<LLD	<LLD	<LLD	<LLD
iodine-133	<LLD	5.18E-04	5.16E-04	<LLD	1.03E-03
iodine-134	<LLD	<LLD	<LLD	<LLD	<LLD
iodine-135	<LLD	<LLD	<LLD	<LLD	<LLD
Total iodines for period *	<LLD	5.63E-04	5.70E-04	<LLD	1.13E-03

* Less than (<) values are not included in the totals
See Table 3-6 for LLD values.

**Table 3-1 Main Plant Vent Releases (Continued)
Particulates and Tritium**

Report Period: January -- December 2000

Nuclides Released	1st Quarter (Ci)	2nd Quarter (Ci)	3rd Quarter (Ci)	4th Quarter (Ci)	Year (Ci)
-------------------	------------------------	------------------------	------------------------	------------------------	--------------

C. Particulates

strontium-89	7.83E-06	<LLD	4.30E-06	2.64E-06	1.48E-05
strontium-90	1.12E-06	<LLD	4.91E-07	<LLD	1.61E-06
cesium-134	<LLD	<LLD	<LLD	<LLD	<LLD
cesium-137	<LLD	<LLD	<LLD	<LLD	<LLD
barium-lanthanum-140	<LLD	<LLD	<LLD	<LLD	<LLD
molybdenum-99	<LLD	<LLD	<LLD	<LLD	<LLD
cerium-141	<LLD	<LLD	<LLD	<LLD	<LLD
cerium-144	<LLD	<LLD	<LLD	<LLD	<LLD
cobalt-58	<LLD	<LLD	<LLD	<LLD	<LLD
cobalt-60	<LLD	<LLD	<LLD	<LLD	<LLD
iron-59	<LLD	<LLD	<LLD	<LLD	<LLD
manganese-54	<LLD	<LLD	<LLD	<LLD	<LLD
zinc-65	<LLD	<LLD	<LLD	<LLD	<LLD
Others					
chrome-51	<LLD	<LLD	<LLD	<LLD	<LLD
Total particulates for period*	8.95E-06	0.00E+00	4.79E-06	2.64E-06	1.64E-05

Others with T 1/2 < 8 days					
arsenic-76	<LLD	<LLD	<LLD	<LLD	<LLD
copper-64	<LLD	<LLD	<LLD	<LLD	<LLD
sodium-24	<LLD	<LLD	<LLD	<LLD	<LLD
technetium-99m	<LLD	<LLD	<LLD	<LLD	<LLD
zinc-69m	<LLD	<LLD	<LLD	<LLD	<LLD
Total with T 1/2 < 8 days*	<LLD	<LLD	<LLD	<LLD	<LLD

D. Tritium

tritium	8.10E-01	1.07E+00	1.59E+00	1.83E+00	5.29E+00
---------	----------	----------	----------	----------	----------

* Less than (<) values are not included in the totals.
See Table 3-6 for LLD values.

**Table 3-2 Turbine Building Releases
Fission Gases and Iodines**

Report Period: January -- December 2000

Nuclides Released	1st Quarter (Ci)	2nd Quarter (Ci)	3rd Quarter (Ci)	4th Quarter (Ci)	Year (Ci)
-------------------	------------------------	------------------------	------------------------	------------------------	--------------

A. Fission gases

krypton-85	<LLD	<LLD	<LLD	<LLD	<LLD
krypton-85m	<LLD	<LLD	<LLD	<LLD	<LLD
krypton-87	<LLD	<LLD	<LLD	<LLD	<LLD
krypton-88	<LLD	<LLD	<LLD	<LLD	<LLD
xenon-133	<LLD	<LLD	<LLD	<LLD	<LLD
xenon-133m	<LLD	<LLD	<LLD	<LLD	<LLD
xenon-135	<LLD	<LLD	<LLD	<LLD	<LLD
xenon-135m	<LLD	<LLD	<LLD	<LLD	<LLD
xenon-138	<LLD	<LLD	<LLD	<LLD	<LLD
Others					
argon-41	<LLD	<LLD	<LLD	<LLD	<LLD
Total fission gases for period *	<LLD	<LLD	<LLD	<LLD	<LLD

B. Iodines

iodine-131	<LLD	7.13E-06	<LLD	<LLD	7.13E-06
iodine-132	<LLD	<LLD	<LLD	<LLD	<LLD
iodine-133	<LLD	8.97E-06	2.16E-05	<LLD	3.05E-05
iodine-134	<LLD	<LLD	<LLD	<LLD	<LLD
iodine-135	<LLD	<LLD	<LLD	<LLD	<LLD
Total iodines for period *	<LLD	1.61E-05	2.16E-05	<LLD	3.77E-05

* Less than (<) values are not included in the totals.
See Table 3-6 for LLD values.

**Table 3-2 Turbine Building Releases (Continued)
Particulates and Tritium**

Report Period: January -- December 2000

Nuclides Released	1st Quarter (Ci)	2nd Quarter (Ci)	3rd Quarter (Ci)	4th Quarter (Ci)	Year (Ci)
-------------------	------------------------	------------------------	------------------------	------------------------	--------------

C. Particulates

strontium-89	9.48E-06	2.91E-05	2.71E-05	1.94E-05	8.50E-05
strontium-90	<LLD	<LLD	1.34E-06	<LLD	1.34E-06
cesium-134	<LLD	<LLD	<LLD	<LLD	<LLD
cesium-137	<LLD	<LLD	<LLD	<LLD	<LLD
barium-lanthanum-140	<LLD	<LLD	<LLD	<LLD	<LLD
molybdenum-99	<LLD	<LLD	<LLD	<LLD	<LLD
cerium-141	<LLD	<LLD	<LLD	<LLD	<LLD
cerium-144	<LLD	<LLD	<LLD	<LLD	<LLD
cobalt-58	<LLD	<LLD	<LLD	<LLD	<LLD
cobalt-60	<LLD	<LLD	<LLD	<LLD	<LLD
iron-59	<LLD	<LLD	<LLD	<LLD	<LLD
manganese-54	<LLD	<LLD	<LLD	<LLD	<LLD
zinc-65	<LLD	<LLD	<LLD	<LLD	<LLD
Others					
chrome-51	<LLD	<LLD	<LLD	<LLD	<LLD
Total particulates for period*	9.48E-06	2.91E-05	2.85E-05	1.94E-05	8.64E-05

Others with T1/2 < 8 days	
None	No nuclides with half-lives less than 8 days were identified
Total with T1/2 < 8 days*	No nuclides with half-lives less than 8 days were identified

D. Tritium

tritium	6.11E+00	1.19E+01	1.34E+01	1.66E+01	4.80E+01
---------	----------	----------	----------	----------	----------

* Less than (<) values are not included in the totals.
See Table 3-6 for LLD values.

**Table 3-3 Radwaste Building Releases
Fission Gases and Iodines**

Report Period: January -- December 2000

Nuclides Released	1st Quarter (Ci)	2nd Quarter (Ci)	3rd Quarter (Ci)	4th Quarter (Ci)	Year (Ci)
-------------------	------------------------	------------------------	------------------------	------------------------	--------------

A. Fission gases

krypton-85	<LLD	<LLD	<LLD	<LLD	<LLD
krypton-85m	<LLD	<LLD	<LLD	<LLD	<LLD
krypton-87	<LLD	<LLD	<LLD	<LLD	<LLD
krypton-88	<LLD	<LLD	<LLD	<LLD	<LLD
xenon-133	<LLD	<LLD	<LLD	<LLD	<LLD
xenon-133m	<LLD	<LLD	<LLD	<LLD	<LLD
xenon-135	<LLD	<LLD	<LLD	<LLD	<LLD
xenon-135m	<LLD	<LLD	<LLD	<LLD	<LLD
xenon-138	<LLD	<LLD	<LLD	<LLD	<LLD
Others					
NONE					
Total fission gases for period *	<LLD	<LLD	<LLD	<LLD	<LLD

B. Iodines

iodine-131	<LLD	<LLD	<LLD	<LLD	<LLD
iodine-132	<LLD	<LLD	<LLD	<LLD	<LLD
iodine-133	<LLD	<LLD	<LLD	<LLD	<LLD
iodine-134	<LLD	<LLD	<LLD	<LLD	<LLD
iodine-135	<LLD	<LLD	<LLD	<LLD	<LLD
Total iodines for period*	<LLD	<LLD	<LLD	<LLD	<LLD

* Less than (<) values are not included in the totals.

See Table 3-6 for LLD values.

**Table 3-3 Radwaste Building Releases (Continued)
Particulates and Tritium**

Report Period: January -- December 2000

Nuclides Released	1st Quarter (Ci)	2nd Quarter (Ci)	3rd Quarter (Ci)	4th Quarter (Ci)	Year (Ci)
-------------------	------------------------	------------------------	------------------------	------------------------	--------------

C. Particulates

strontium-89	<LLD	<LLD	<LLD	<LLD	<LLD
strontium-90	<LLD	<LLD	<LLD	<LLD	<LLD
cesium-134	<LLD	<LLD	<LLD	<LLD	<LLD
cesium-137	<LLD	<LLD	<LLD	<LLD	<LLD
barium-lanthanum-140	<LLD	<LLD	<LLD	<LLD	<LLD
molybdenum-99	<LLD	<LLD	<LLD	<LLD	<LLD
cerium-141	<LLD	<LLD	<LLD	<LLD	<LLD
cerium-144	<LLD	<LLD	<LLD	<LLD	<LLD
cobalt-58	<LLD	<LLD	<LLD	<LLD	<LLD
cobalt-60	<LLD	<LLD	<LLD	<LLD	<LLD
iron-59	<LLD	<LLD	<LLD	<LLD	<LLD
manganese-54	<LLD	<LLD	<LLD	<LLD	<LLD
zinc-65	<LLD	<LLD	<LLD	<LLD	<LLD
Others					
None	No other nuclides were identified				
Total particulates for period*	<LLD	<LLD	<LLD	<LLD	<LLD

Others (T1/2 < 8 days)	No other nuclides were identified				
Total with T1/2 < 8days*	No nuclides with half-lives less than 8 days were identified				

D. Tritium

tritium	1.99E-01	1.56E-01	5.18E-01	2.88E-01	1.16E+00
---------	----------	----------	----------	----------	----------

* Less than (<) values are not included in the totals.

See Table 3-6 for LLD values.

**Table 3-4 Summation of Releases
Gaseous Effluents**

Report Period: January -- December 2000

1st Quarter	2nd Quarter	3rd Quarter	4th Quarter	Year	Est Total Error*%
----------------	----------------	----------------	----------------	------	-------------------------

A. Fission and activation gases

Total release (Ci)	3.14E+00	3.13E+00	1.91E+00	6.00E+00	1.42E+01	3.60E+01
Average release rate (μCi/s)	4.00E-01	3.98E-01	2.40E-01	7.55E-01	4.49E-01	
Percent of ODCM limit (%)	**	**	**	**	**	

B. Iodines

Total I-131 (Ci)	0.00E+00	5.16E-05	5.42E-05	< LLD	1.06E-04	3.60E+01
Average release rate (μCi/s)	0.00E+00	6.57E-06	6.82E-06	< LLD	3.35E-06	
Percent of ODCM limit (%)	**	**	**	**	**	

C. Particulates

Particulates with half-lives > 8 days (Ci)	1.84E-05	2.91E-05	3.32E-05	2.20E-05	1.03E-04	3.60E+01
Average release rate (μCi/s)	2.34E-06	3.70E-06	4.18E-06	2.77E-06	3.25E-06	
Percent of ODCM limit (%)	**	**	**	**	**	
Gross alpha radioactivity	4.18E-06	2.87E-06	4.82E-06	3.08E-06	1.50E-05	

D. Tritium

Total release (Ci)	7.12E+00	1.31E+01	1.56E+01	1.87E+01	5.45E+01	3.60E+01
Average release rate (μCi/s)	9.05E-01	1.67E+00	1.96E+00	2.35E+00	1.72E+00	
Percent of ODCM limit (%)	**	**	**	**	**	

* At 95% confidence level

** ODCM limits are based on dose.

See Table 3-0 for percent of ODCM limits.

Table 3-5 Gaseous Batch Releases

Report Period: January -- December 2000

Type	Number	Total Time (hr.)	Maximum Time (hr.)	Minimum Time (hr.)	Mean Time (hr.)
Purge	5.00E+00	7.09E+01	3.32E+01	2.63E+00	1.42E+01
Vent	6.00E+01	8.93E+01	1.77E+01	3.00E-01	1.49E+00

**Table 3-6 Lower Limits of Detection
Gaseous Effluents**

Reporting Period: January -- December 2000

Fission Gases

Nuclide	LLD ($\mu\text{Ci/cc}$)
krypton-85	2.60E-07
krypton-85m	3.70E-07
krypton-87	3.00E-09
krypton-88	1.30E-08
xenon-133	1.10E-08
xenon-135	1.32E-09
xenon-135m	4.00E-09
xenon-138	1.20E-08
argon-41	2.60E-09
xenon-137	6.70E-08

Iodines

Nuclide	LLD ($\mu\text{Ci/cc}$)
iodine-131	2.40E-13
iodine-132	3.90E-13
iodine-133	3.50E-13
iodine-134	5.60E-13
iodine-135	1.60E-12

Particulates

Nuclide	LLD ($\mu\text{Ci/cc}$)
strontium-89	5.50E-15
strontium-90	4.20E-15
cesium-134	5.30E-13
cesium-137	3.20E-13
barium-lanthanum-140	1.10E-12
molybdenum-99	3.20E-12
cerium-141	2.30E-13
cerium-144	1.60E-12
cobalt-58	3.20E-13
cobalt-60	6.00E-13
iron-59	1.10E-12
manganese-54	3.70E-13
zinc-65	1.10E-12
Gross Alpha	4.30E-16

4.0 Solid Radwaste

Information required by Columbia Generating Station Offsite Dose Calculation Manual

Class A

1. Container Volumes
 - * B-25 Steel Box 92.5 ft³
 - * ES-190 Steel Liner 170.2 ft³
 - * EL-142 Polyethylene HIC 132.4 ft³
 - * Sea Land Container (CVAN) N/A
2. Total Curies
 - * 6.60E+02 Ci
3. Principal Radionuclides

Nuclide	Percent	Curies
Co-60	5.15E+01	3.40E+02
Zn-65	2.45E+01	1.62E+02
Mn-54	6.85E+00	4.53E+01
Co-58	6.26E+00	4.14E+01
Cr-51	5.85E+00	3.86E+01
Fe-55	2.47E+00	1.63E+01
Nb-95	6.76E-01	4.47E+00
Ni-63	5.73E-01	3.79E+00
Zr-95	4.41E-01	2.91E+00
Cs-137	2.75E-01	1.81E+00
Fe-59	2.00E-01	1.32E+00
Ag-110m	1.48E-01	9.78E-01
C-14	1.37E-01	9.04E-01
Tc-99	4.50E-02	2.94E-01
Sb-124	2.50E-02	1.68E-01

4. Source
 - * Resins 6.59E+02 Ci
 - * DAW 1.36E+00 Ci
 - * Irradiated Components None
 - * Other (Sealed Source) 5.17E-04 Ci
5. Type of Container
 - * All containers shipped as LSA, SCO or Radioactive material, n.o.s. in IP-1, IP-2 or Type A (including casks) as appropriate.
6. Solidification Agent
 - * None

Class B

None

Class C

1. Container Volumes
 - * FSV-1 Steel Liner 26.2 ft³
 - * NUHIC Polyethylene HIC 136.3 ft³
2. Total Curies
 - * 7.43E+04 Ci
3. Principal Radionuclides

Nuclide	Percent	Curies
Co-60	6.35E+01	4.72E+04
Fe-55	3.13E+01	2.32E+04
Ni-63	4.96E+00	3.68E+03
Mn-54	1.46E-01	1.08E+02
Ni-59	3.00E-02	2.21E+01
Cr-51	2.20E-02	1.63E+01
Zn-65	1.40E-02	1.02E+01
C-14	7.00E-03	4.92E+00
Co-58	4.00E-03	2.69E+00
Sb-125	2.00E-03	1.74E+00
H-3	1.00E-03	8.43E-01
Cs-137	1.00E-03	6.55E-01

4. Source
 - * Resins None
 - * DAW 6.31E+01 Ci
 - * Irradiated Components 7.42E+04 Ci
 - * Other None
5. Type of Container
 - * All containers shipped as Radioactive material, n.o.s. in Type B
6. Solidification Agent
 - * None

Information required by Reg. Guide 1.21

January -- December 2000.

Solid waste shipped offsite for burial or disposal (not irradiated fuel).

1. Type of Waste

Waste Stream	Unit	Annual Cumulative	Est. Total Error %
a. Spent resins, filter sludge, evaporator bottoms, etc.	m ³	1.37E+02	
	Ci	6.59E+02	2.5E+01 %
b. Dry Active Waste	m ³	4.21E+01	-
	Ci	6.45E+01	2.5E+01 %
c. Irradiated Components	m ³	5.21E+00	-
	Ci	7.42E+04	-
d. Other Waste (Sealed Source)	m ³	8.64E-05	-
	Ci	5.17E-04	-

2. Estimate of major nuclide composition (by type of waste)

a. Dewatered Spent Resins -- All Classes

Nuclide	%	Curies
Co-60	5.15E+01	3.40E+02
Zn-65	2.45E+01	1.61E+02
Mn-54	6.86E+00	4.52E+01
Co-58	6.27E+00	4.13E+01
Cr-51	5.81E+00	3.83E+01
Fe-55	2.48E+00	1.63E+01
Nb-95	6.75E-01	4.45E+00
Ni-63	5.72E-01	3.77E+00
Zr-95	4.42E-01	2.91E+00

Cs-137	2.70E-01	1.78E+00
Fe-59	2.01E-01	1.32E+00
Ag-110m	1.48E-01	9.78E-01
C-14	1.37E-01	9.03E-01
Tc-99	4.50E-02	2.94E-01
Sb-124	2.50E-02	1.68E-01

b. Dry Active Waste (DAW) -- All Classes

Nuclide	%	Curies
Co-60	3.82E+01	2.46E+01
Cr-51	2.58E+01	1.67E+01
Zn-65	1.64E+01	1.05E+01
Fe-55	8.57E+00	5.52E+00
Co-58	4.23E+00	2.73E+00
Mn-54	2.47E+00	1.59E+00
Ni-63	1.22E+00	7.87E-01
Cs-137	1.07E+00	6.89E-01
Sb-125	9.36E-01	6.03E-01
H-3	8.96E-01	5.77E-01
Ce-144	1.08E-01	6.96E-02
C-14	6.30E-02	4.07E-02

c. Irradiated Components

Nuclide	%	Curies
Co-60	6.36E+01	4.72E+04
Fe-55	3.13E+01	2.32E+04
Ni-63	4.96E+00	3.68E+03
Mn-54	1.44E-01	1.07E+02
Ni-59	3.00E-02	2.21E+01
C-14	7.00E-03	4.88E+00
Sb-125	2.00E-03	1.14E+00

d. Other Waste (Sealed Source)

Nuclide	%	Curies
Co-60	6.85E+01	3.54E-04
Cr-51	1.35E+01	7.00E-05
Zn-65	4.22E+00	2.18E-05
Mn-54	3.85E+00	1.99E-05
Fe-55	3.25E+00	1.68E-05
Co-58	3.21E+00	1.66E-05
Ni-63	2.23E+00	1.15E-05
Nb-95	1.02E+00	5.28E-06
C-14	1.91E-01	9.85E-07
Th-231	3.50E-03	1.81E-08
U-235	3.50E-03	1.81E-08

3. Solid Waste Disposition

<u>Number of Shipments</u>	<u>Mode of Transportation</u>	<u>Destination</u>
29	Tractor - Trailer via Public Highway	US Ecology, Inc. P.O. Box 638 Hanford Reservation Richland, WA. 99352
8*	Tractor - Trailer via Public Highway	ATG, Inc. 2025 Battelle Blvd. Richland, WA. 99352

* After volume reduction by ATG, Inc., portions of these shipments were forwarded to US Ecology, Inc. in four (4) shipments.

Irradiated Fuel Shipments (Disposition)

<u>Number of Shipments</u>	<u>Mode of Transportation</u>	<u>Destination</u>
None	N/A	N/A

5.0 Meteorology

The meteorological data contained in Tables 5-1 through 5-10 were obtained from the meteorological tower located 2500 ft (762 m) west of Columbia Generating Station. Data was recovered from instruments at the 33 ft (10 m) and 245 ft (75 m) above ground level (AGL). The meteorological data is a composite file from the automated data recovery systems for the calendar year 2000. Data is archived on the Energy Northwest Local Area Network.

Total precipitation measured at the Hanford Meteorology Station, located 14 miles northwest of the station, was 8.08 inches, 129% of the normal annual rainfall (6.26 inches). February was the wettest month with 1.12 inches of precipitation. August was the driest month with only a trace of precipitation. There was a total of 8.2 inches of snow in January, compared to the normal 3.9 inches. February received 0.5 inches, 1.5 inches below normal and there was no snowfall recorded in March. Normal snowfall for the period of January through March is 6.2 inches (15.7 cm). A total of 1.2 inches fell in November and 6.6 inches fell in December. The normal total snowfall for the November-December period is 7.5 inches.

Calendar year 2000 was cooler than normal, averaging 52.6°F (11.4°C) or 0.7°F below normal. The warmest day occurred on July 31 with high temperature of 107°F (41.7°C). The coldest days occurred on December 11 and December 15, with a low temperature of 13°F (-10.6°C). The occurrence of fog and haze and blowing dust in 2000 was similar to that observed in previous years. In summary, the dispersive environment for Columbia Generating Station for 2000 was near normal.

Joint data recovery for 2000 was 96.6% from the 245-foot level and 97.4% from the 33-foot level. Several outages of the windspeed, wind direction, and temperature channels occurred, due either to sensor or recorder problems. Most of these were returned to service within seven days. The December data for the wind direction at the 245-foot level required editing due to the sensor sticking for extended periods. Weather conditions did not allow personnel access to the 245' level to repair the direction sensors. Lightning strikes and thunderstorms were of minor concern and had no significant effect on meteorological tower operations.

The data in Tables 5-1 through 5-8 list the joint frequency distributions at the 33-ft and 245-ft levels by quarter for 2000. Table 5-9 and 5-10 list the annual joint frequency distributions for those levels for 2000. The NRC stability classes A through G and seven wind categories along with the 16 wind sectors were used to prepare each joint frequency table. The annual joint frequency tables should be used to evaluate any vents and purges during 2000 as the releases were random in time.

Calibrations performed in 2000 required no corrections be applied to the raw data. Data below 0.07 MPH has been determined to result from system malfunction and is not included in the results.

Joint Frequency Distribution Tables

Table 5-1 1st Quarter 2000, 33 FT AGL

JOINT FREQUENCY DISTRIBUTION FOR THE TIME PERIOD FROM HOUR 00 ON 01/01/00 TO HOUR 23 ON 03/31/00. The total hours are 2184 (2178 hours read and 6 missing).

NRC CATEGORY A

deg	MPH						
	0.07	0.60	3.00	7.00	12.00	18.00	24.00
0.00	0	1	0	0	0	0	0
11.25	0	0	0	0	0	0	0
33.75	0	0	0	0	0	0	0
56.25	0	0	0	0	0	0	0
78.75	0	0	0	0	0	0	0
101.25	0	0	0	0	0	0	0
123.75	0	0	0	0	0	0	0
146.25	0	0	0	0	0	0	0
168.75	0	0	0	0	0	0	0
191.25	0	0	0	0	0	0	0
213.75	0	0	1	0	0	0	0
236.25	0	0	0	0	0	0	0
258.75	0	0	0	0	0	0	0
281.25	0	0	0	0	0	0	0
303.75	0	0	0	0	0	0	0
326.25	0	0	0	0	0	0	0

NRC CATEGORY B

deg	MPH						
	0.07	0.60	3.00	7.00	12.00	18.00	24.00
0.00	0	0	0	0	0	0	0
11.25	0	2	1	0	0	0	0
33.75	0	0	0	0	0	0	0
56.25	0	0	0	0	0	0	0
78.75	0	0	0	0	0	0	0
101.25	0	0	0	0	0	0	0
123.75	0	0	0	0	0	0	0
146.25	0	0	0	0	0	0	0
168.75	0	0	0	0	0	0	0
191.25	0	1	0	0	0	0	0
213.75	0	0	0	0	0	0	0
236.25	0	0	0	0	0	0	0
258.75	0	1	0	0	0	0	0
281.25	0	0	0	0	0	0	0
303.75	0	0	0	0	0	0	0
326.25	0	0	0	0	0	0	0

NRC CATEGORY C

deg	MPH						
	0.07	0.60	3.00	7.00	12.00	18.00	24.00
0.00	0	1	1	0	0	0	0
11.25	0	1	1	0	0	0	0
33.75	0	1	0	0	0	0	0
56.25	0	1	0	0	0	0	0
78.75	0	0	0	0	0	0	0
101.25	0	1	1	0	0	0	0
123.75	0	0	2	0	0	0	0
146.25	1	0	1	0	0	0	0
168.75	0	1	0	0	2	0	0
191.25	0	0	0	0	0	0	0
213.75	1	2	0	0	0	0	0
236.25	1	0	0	0	0	0	0
258.75	0	0	0	0	0	0	0
281.25	0	0	0	0	0	0	0
303.75	0	1	0	0	0	0	0
326.25	0	1	0	0	0	0	0

NRC CATEGORY D

deg	MPH						
	0.07	0.60	3.00	7.00	12.00	18.00	24.00
0.00	0	0	6	1	0	0	0
11.25	2	7	6	0	0	0	0
33.75	1	1	1	0	0	0	0
56.25	2	0	0	0	0	0	0
78.75	0	1	0	0	0	0	0
101.25	0	1	1	0	0	0	0
123.75	0	1	11	7	1	0	0
146.25	1	1	24	27	1	0	0
168.75	0	8	12	15	3	1	0
191.25	1	4	3	4	4	1	0
213.75	1	3	4	5	5	2	0
236.25	1	1	6	8	5	2	0
258.75	1	3	6	3	2	0	0
281.25	0	3	2	5	1	0	0
303.75	0	1	9	4	2	2	0
326.25	1	3	12	7	3	1	0

NRC CATEGORY E

deg	MPH						
	0.07	0.60	3.00	7.00	12.00	18.00	24.00
0.00	1	12	9	7	0	0	0
11.25	4	9	7	7	0	0	0
33.75	0	4	2	0	0	0	0
56.25	0	3	4	0	0	0	0
78.75	0	4	2	0	0	0	0
101.25	2	6	5	7	2	0	0
123.75	3	7	27	33	5	1	0
146.25	1	10	43	28	3	3	0
168.75	0	15	27	24	13	8	2
191.25	3	7	14	14	21	4	3
213.75	4	7	13	7	6	4	1
236.25	2	9	13	7	8	6	2
258.75	3	12	15	40	7	0	0
281.25	4	21	45	94	16	0	0
303.75	1	13	62	49	11	0	0
326.25	1	14	37	22	3	1	0

NRC CATEGORY F

deg	MPH						
	0.07	0.60	3.00	7.00	12.00	18.00	24.00
0.00	2	10	15	0	0	0	0
11.25	0	3	9	1	0	0	0
33.75	0	4	2	2	0	0	0
56.25	0	2	0	0	0	0	0
78.75	0	2	0	2	0	0	0
101.25	1	0	1	3	0	0	0
123.75	1	2	10	17	0	0	0
146.25	1	6	30	44	6	0	0
168.75	2	9	16	24	2	2	0
191.25	1	14	13	13	10	2	0
213.75	2	6	7	1	3	0	0
236.25	0	8	6	8	0	0	0
258.75	2	17	7	9	0	0	0
281.25	0	16	26	18	1	0	0
303.75	3	9	47	11	0	0	0
326.25	1	17	24	1	0	0	0

NRC CATEGORY G

	MPH						
deg	0.07	0.60	3.00	7.00	12.00	18.00	24.00
0.00	1	10	9	1	0	0	0
11.25	0	10	4	1	0	0	0
33.75	1	3	2	0	0	0	0
56.25	1	1	0	0	0	0	0
78.75	0	2	0	0	0	0	0
101.25	1	2	0	1	0	0	0
123.75	1	2	5	3	0	0	0
146.25	0	4	33	18	0	0	0
168.75	1	4	20	9	0	0	0
191.25	3	5	4	10	0	0	0
213.75	0	13	5	1	0	0	0
236.25	0	11	4	3	0	0	0
258.75	0	5	7	0	0	0	0
281.25	3	14	21	9	0	0	0
303.75	1	14	39	4	0	0	0
326.25	2	16	21	1	0	0	0

Table 5-2 1st Quarter 2000, 245 FT AGL

JOINT FREQUENCY DISTRIBUTION FOR THE TIME PERIOD FROM HOUR 00 ON 01/01/00 TO HOUR 23 ON 03/31/00. The total hours are 2184 (2180 hours read and 4 missing).

NRC CATEGORY A

deg	MPH						
	0.07	0.60	3.00	7.00	12.00	18.00	24.00
0.00	0	0	0	0	0	0	0
11.25	0	1	0	0	0	0	0
33.75	0	0	0	0	0	0	0
56.25	0	0	0	0	0	0	0
78.75	0	0	0	0	0	0	0
101.25	0	0	0	0	0	0	0
123.75	0	0	0	0	0	0	0
146.25	0	0	0	0	0	0	0
168.75	0	0	0	0	0	0	0
191.25	0	0	0	0	0	0	0
213.75	0	0	0	0	0	0	0
236.25	0	0	1	0	0	0	0
258.75	0	0	0	0	0	0	0
281.25	0	0	0	0	0	0	0
303.75	0	0	0	0	0	0	0
326.25	0	0	0	0	0	0	0

NRC CATEGORY B

deg	MPH						
	0.07	0.60	3.00	7.00	12.00	18.00	24.00
0.00	0	0	0	0	0	0	0
11.25	0	0	1	0	0	0	0
33.75	0	0	1	0	0	0	0
56.25	0	0	0	0	0	0	0
78.75	0	0	0	0	0	0	0
101.25	0	1	0	0	0	0	0
123.75	0	0	0	0	0	0	0
146.25	0	0	0	0	0	0	0
168.75	0	0	0	0	0	0	0
191.25	0	1	0	0	0	0	0
213.75	0	0	1	0	0	0	0
236.25	0	0	0	0	0	0	0
258.75	0	0	0	0	0	0	0
281.25	0	0	0	0	0	0	0
303.75	0	0	0	0	0	0	0
326.25	0	0	0	0	0	0	0

NRC CATEGORY C

deg	MPH						
	0.07	0.60	3.00	7.00	12.00	18.00	24.00
0.00	0	0	0	0	0	0	0
11.25	0	0	1	0	0	0	0
33.75	0	1	1	0	0	0	0
56.25	0	1	0	0	0	0	0
78.75	0	1	0	0	0	0	0
101.25	0	0	0	0	0	0	0
123.75	0	0	1	0	0	0	0
146.25	0	2	1	1	0	0	0
168.75	0	1	1	0	1	0	0
191.25	0	1	1	0	1	0	0
213.75	0	1	0	0	0	0	0
236.25	0	1	0	0	0	0	0
258.75	0	0	0	0	0	0	0
281.25	0	1	0	0	0	0	0
303.75	1	1	0	0	0	0	0
326.25	0	0	0	0	0	0	0

NRC CATEGORY D

deg	MPH						
	0.07	0.60	3.00	7.00	12.00	18.00	24.00
0.00	0	1	4	2	3	0	0
11.25	0	3	3	2	0	0	0
33.75	0	2	8	0	0	0	0
56.25	0	0	0	0	0	0	0
78.75	0	1	0	0	0	0	0
101.25	1	1	0	0	0	0	0
123.75	0	1	2	2	0	0	0
146.25	0	3	10	16	6	0	0
168.75	0	3	18	18	8	0	0
191.25	0	7	7	14	8	0	1
213.75	0	4	3	5	6	1	2
236.25	0	2	5	6	7	6	1
258.75	0	2	7	5	4	1	0
281.25	0	1	3	5	4	0	0
303.75	1	0	6	4	0	0	0
326.25	0	0	13	12	1	4	0

NRC CATEGORY E

deg	MPH						
	0.07	0.60	3.00	7.00	12.00	18.00	24.00
0.00	1	3	22	18	2	0	0
11.25	0	3	9	11	1	0	0
33.75	0	2	7	1	2	0	0
56.25	0	2	5	1	0	0	0
78.75	0	1	3	1	0	0	0
101.25	1	5	4	0	0	0	0
123.75	0	5	5	9	7	0	0
146.25	0	4	23	28	9	2	0
168.75	0	8	21	30	25	4	1
191.25	0	7	29	17	12	11	16
213.75	0	12	13	14	17	13	8
236.25	2	4	8	9	3	9	9
258.75	1	8	8	9	6	8	8
281.25	0	9	25	32	63	24	3
303.75	0	7	27	60	68	9	0
326.25	0	5	22	48	22	5	0

NRC CATEGORY F

deg	MPH						
	0.07	0.60	3.00	7.00	12.00	18.00	24.00
0.00	0	5	21	9	1	0	0
11.25	0	2	8	7	0	0	0
33.75	0	1	2	7	1	0	0
56.25	1	0	2	3	0	0	0
78.75	0	4	1	0	0	0	0
101.25	0	1	1	0	0	0	0
123.75	0	3	4	1	1	0	0
146.25	0	2	14	11	14	1	0
168.75	0	5	12	23	23	4	1
191.25	0	4	9	17	22	4	2
213.75	0	3	13	16	14	10	4
236.25	0	6	9	7	3	2	1
258.75	0	6	9	2	5	2	0
281.25	0	4	7	11	16	6	1
303.75	0	4	10	21	27	4	0
326.25	0	4	14	22	13	4	0

NRC CATEGORY G

deg	MPH						
	0.07	0.60	3.00	7.00	12.00	18.00	24.00
0.00	1	2	10	5	0	0	0
11.25	0	5	5	1	1	0	0
33.75	0	1	5	6	1	0	0
56.25	0	0	5	1	0	0	0
78.75	0	2	1	1	0	0	0
101.25	1	3	1	0	0	0	0
123.75	0	2	4	0	0	0	0
146.25	1	1	18	16	7	0	0
168.75	1	10	25	10	2	0	0
191.25	0	3	17	7	3	0	0
213.75	0	7	15	15	2	1	0
236.25	0	3	7	4	4	0	0
258.75	0	3	8	2	2	1	0
281.25	1	3	2	4	5	4	0
303.75	2	1	4	10	36	1	0
326.25	0	4	15	10	4	1	0

Table 5-3 2nd Quarter 2000, 33 FT AGL

JOINT FREQUENCY DISTRIBUTION FOR THE TIME PERIOD FROM HOUR 00 ON 04/01/00 TO HOUR 23 ON 06/30/00. The total hours are 2184 (2167 read and 17 missing).

NRC CATEGORY A

deg	MPH						
	0.07	0.60	3.00	7.00	12.00	18.00	24.00
0.00	0	3	10	9	2	0	0
11.25	0	6	16	20	0	0	0
33.75	1	4	11	6	0	0	0
56.25	0	2	3	0	0	0	0
78.75	1	5	1	1	0	0	0
101.25	1	6	9	6	1	0	0
123.75	0	1	14	22	1	0	0
146.25	0	2	25	30	2	0	0
168.75	0	6	28	22	22	0	0
191.25	0	4	15	14	13	2	0
213.75	0	3	10	14	12	7	1
236.25	0	3	6	7	7	6	1
258.75	0	4	5	10	1	1	2
281.25	0	6	4	4	9	5	2
303.75	0	7	9	11	11	3	0
326.25	0	3	12	9	5	0	0

NRC CATEGORY B

deg	MPH						
	0.07	0.60	3.00	7.00	12.00	18.00	24.00
0.00	0	1	2	1	0	0	0
11.25	0	1	4	0	0	0	0
33.75	0	0	3	1	0	0	0
56.25	0	0	1	0	0	0	0
78.75	0	0	0	0	0	0	0
101.25	0	0	0	0	0	0	0
123.75	0	0	3	4	0	0	0
146.25	0	2	6	4	1	0	0
168.75	0	1	4	6	5	0	0
191.25	0	0	1	6	5	1	0
213.75	0	0	2	5	6	1	1
236.25	0	0	0	1	4	3	1
258.75	0	0	1	2	1	0	0
281.25	0	2	1	1	1	2	0
303.75	0	2	4	2	2	1	2
326.25	0	1	1	5	1	0	0

NRC CATEGORY C

deg	MPH						
	0.07	0.60	3.00	7.00	12.00	18.00	24.00
0.00	0	1	5	1	0	0	0
11.25	0	3	3	0	0	0	0
33.75	0	0	3	0	1	0	0
56.25	0	0	0	0	0	0	0
78.75	0	0	0	0	0	0	0
101.25	1	1	0	1	1	0	0
123.75	0	1	3	4	0	0	0
146.25	0	1	1	4	1	0	0
168.75	0	0	4	7	3	1	0
191.25	0	1	1	5	4	3	1
213.75	0	0	1	1	8	3	0
236.25	0	0	0	4	5	2	0
258.75	0	1	0	1	1	1	0
281.25	0	0	1	2	2	1	0
303.75	0	0	2	2	2	3	0
326.25	0	1	8	1	1	0	0

NRC CATEGORY D

deg	MPH						
	0.07	0.60	3.00	7.00	12.00	18.00	24.00
0.00	0	2	12	6	0	0	0
11.25	0	3	6	3	0	0	0
33.75	0	1	4	0	0	0	0
56.25	0	3	2	1	0	0	0
78.75	1	3	3	2	0	0	0
101.25	1	1	1	6	0	0	0
123.75	1	1	4	14	0	0	0
146.25	0	1	15	11	0	0	0
168.75	1	4	14	17	3	0	0
191.25	0	4	10	3	10	2	1
213.75	0	2	4	5	13	4	1
236.25	0	2	2	2	13	3	1
258.75	1	4	2	3	15	2	0
281.25	0	3	6	7	16	13	1
303.75	0	3	5	8	14	6	1
326.25	0	1	7	15	0	0	0

NRC CATEGORY E

deg	MPH						
	0.07	0.60	3.00	7.00	12.00	18.00	24.00
0.00	0	5	10	0	0	0	0
11.25	1	8	4	1	0	0	0
33.75	0	1	2	0	1	0	0
56.25	1	0	3	2	0	0	0
78.75	0	2	1	1	0	0	0
101.25	0	5	1	2	0	0	0
123.75	0	3	6	10	0	0	0
146.25	1	5	28	17	0	0	0
168.75	0	5	19	23	3	0	0
191.25	0	5	13	8	13	2	0
213.75	0	5	17	7	3	1	0
236.25	1	5	19	5	1	1	0
258.75	0	3	10	28	9	0	0
281.25	1	7	11	37	46	9	1
303.75	0	10	23	24	13	2	0
326.25	0	3	19	4	1	0	0

NRC CATEGORY F

deg	MPH						
	0.07	0.60	3.00	7.00	12.00	18.00	24.00
0.00	1	7	14	0	0	0	0
11.25	0	5	5	0	0	0	0
33.75	0	7	3	0	0	0	0
56.25	0	3	0	0	0	0	0
78.75	0	1	0	0	0	0	0
101.25	0	3	3	0	0	0	0
123.75	1	3	5	6	0	0	0
146.25	1	8	31	13	0	0	0
168.75	0	7	14	5	0	0	0
191.25	0	5	5	1	0	0	0
213.75	0	4	2	3	0	0	0
236.25	1	0	0	3	0	0	0
258.75	1	4	5	6	1	0	0
281.25	1	0	7	7	2	0	0
303.75	0	6	21	13	0	0	0
326.25	0	10	20	2	0	0	0

NRC CATEGORY G

	MPH						
deg	0.07	0.60	3.00	7.00	12.00	18.00	24.00
0.00	0	8	4	0	0	0	0
11.25	0	19	9	0	0	0	0
33.75	2	6	4	2	0	0	0
56.25	1	1	0	0	0	0	0
78.75	1	3	0	0	0	0	0
101.25	1	0	1	0	0	0	0
123.75	0	7	4	2	0	0	0
146.25	0	5	16	3	0	0	0
168.75	0	3	15	1	0	0	0
191.25	0	5	7	2	0	0	0
213.75	0	3	1	1	0	0	0
236.25	1	6	1	0	0	0	0
258.75	1	3	1	0	1	0	0
281.25	1	10	4	2	0	0	0
303.75	0	7	11	6	0	0	0
326.25	0	4	7	2	0	0	0

Table 5-4 2nd Quarter 2000, 245 FT AGL

JOINT FREQUENCY DISTRIBUTION FOR THE TIME PERIOD FROM HOUR 00 ON 04/01/00 TO HOUR 23 ON 06/30/00. The total hours are 2184 (2166 read and 18 missing).

NRC CATEGORY A

deg	MPH						
	0.07	0.60	3.00	7.00	12.00	18.00	24.00
0.00	0	2	7	12	6	0	0
11.25	0	3	7	17	2	0	0
33.75	0	0	9	18	1	0	0
56.25	0	3	4	2	0	0	0
78.75	0	1	3	1	0	0	0
101.25	0	2	3	4	2	0	0
123.75	0	3	5	11	5	2	0
146.25	0	4	16	25	2	0	0
168.75	1	3	17	42	4	0	0
191.25	0	1	15	22	31	5	0
213.75	0	1	7	19	21	7	5
236.25	0	1	8	7	4	6	5
258.75	0	1	3	10	7	3	8
281.25	0	2	9	1	8	5	0
303.75	0	4	9	4	10	8	5
326.25	0	2	13	8	12	0	0

NRC CATEGORY B

deg	MPH						
	0.07	0.60	3.00	7.00	12.00	18.00	24.00
0.00	0	1	0	3	3	0	0
11.25	0	0	2	2	0	0	0
33.75	0	2	3	2	0	0	0
56.25	0	0	2	0	0	0	0
78.75	0	0	0	0	0	0	0
101.25	0	0	0	0	0	0	0
123.75	0	0	0	1	1	0	0
146.25	0	0	3	3	2	0	0
168.75	0	0	6	3	3	0	0
191.25	0	1	3	2	9	2	0
213.75	0	0	1	4	4	3	2
236.25	0	0	0	3	8	3	4
258.75	0	0	0	1	1	2	1
281.25	0	1	1	2	0	0	1
303.75	0	2	2	2	1	2	4
326.25	0	0	2	2	1	0	0

NRC CATEGORY C

deg	MPH						
	0.07	0.60	3.00	7.00	12.00	18.00	24.00
0.00	0	0	9	3	0	0	0
11.25	0	1	2	0	0	0	0
33.75	0	1	1	3	1	0	0
56.25	0	0	1	0	0	0	0
78.75	0	0	0	0	0	0	0
101.25	0	0	1	0	0	0	0
123.75	0	0	0	2	3	0	0
146.25	0	2	2	1	0	0	0
168.75	0	1	1	4	3	0	0
191.25	0	0	3	4	7	2	1
213.75	0	0	1	3	1	6	3
236.25	0	0	0	1	5	9	3
258.75	0	1	1	2	1	2	1
281.25	0	0	1	1	0	3	0
303.75	0	1	1	1	1	1	3
326.25	0	1	4	1	2	0	0

NRC CATEGORY D

deg	MPH						
	0.07	0.60	3.00	7.00	12.00	18.00	24.00
0.00	0	1	10	9	2	0	0
11.25	0	0	5	4	1	0	0
33.75	0	3	4	2	2	0	0
56.25	0	0	2	2	1	0	0
78.75	0	1	0	1	0	0	0
101.25	0	0	2	2	3	0	0
123.75	0	1	2	4	6	0	0
146.25	0	2	4	9	3	0	0
168.75	0	4	11	7	6	0	0
191.25	0	5	6	17	13	0	1
213.75	0	0	3	5	4	8	7
236.25	0	4	4	4	9	9	7
258.75	0	3	1	1	5	15	4
281.25	0	3	6	5	6	7	11
303.75	0	1	1	4	12	13	16
326.25	0	4	4	11	6	1	0

NRC CATEGORY E

deg	MPH						
	0.07	0.60	3.00	7.00	12.00	18.00	24.00
0.00	0	2	4	9	3	1	0
11.25	0	2	6	4	1	0	0
33.75	0	1	2	3	0	1	0
56.25	0	1	1	1	0	0	0
78.75	0	2	1	1	2	0	0
101.25	0	2	3	2	1	0	0
123.75	0	1	3	2	3	1	0
146.25	0	1	5	7	7	1	0
168.75	0	2	11	11	8	1	0
191.25	0	2	2	11	14	6	0
213.75	0	2	8	14	10	14	4
236.25	0	2	14	15	5	3	2
258.75	0	1	10	14	11	3	3
281.25	0	2	10	13	25	41	22
303.75	0	2	9	14	39	29	11
326.25	0	1	9	14	4	3	0

NRC CATEGORY F

deg	MPH						
	0.07	0.60	3.00	7.00	12.00	18.00	24.00
0.00	0	1	6	8	0	0	0
11.25	0	1	4	4	0	0	0
33.75	1	1	4	1	0	0	0
56.25	0	1	3	3	1	0	0
78.75	0	1	2	3	1	0	0
101.25	1	1	2	0	0	0	0
123.75	0	3	2	2	1	0	0
146.25	0	3	10	7	2	0	0
168.75	0	1	9	16	6	0	0
191.25	0	0	10	6	4	0	0
213.75	0	1	8	5	3	0	0
236.25	0	3	10	3	0	0	0
258.75	0	2	2	2	5	0	0
281.25	0	1	3	5	8	6	2
303.75	0	2	3	11	23	6	0
326.25	0	0	8	13	7	2	0

NRC CATEGORY G

deg	MPH						
	0.07	0.60	3.00	7.00	12.00	18.00	24.00
0.00	0	1	5	1	0	0	0
11.25	0	3	3	2	0	0	0
33.75	0	4	4	3	1	1	0
56.25	0	1	5	1	1	0	0
78.75	0	0	4	0	1	0	0
101.25	0	0	2	0	0	0	0
123.75	0	2	2	1	1	0	0
146.25	0	1	11	4	1	0	0
168.75	0	6	8	16	1	0	0
191.25	0	1	6	7	2	0	0
213.75	0	4	12	6	0	0	0
236.25	0	1	3	4	1	0	0
258.75	1	1	3	0	1	0	0
281.25	0	0	1	1	5	2	0
303.75	0	0	6	1	12	4	0
326.25	0	2	9	6	6	0	0

Table 5-5 3rd Quarter 2000, 33 FT AGL

JOINT FREQUENCY DISTRIBUTION FOR THE TIME PERIOD FROM HOUR 00 ON 07/01/00 TO HOUR 23 ON 09/30/00. The total hours are 2208 (2201 read and 7 missing).

NRC CATEGORY A

deg	MPH						
	0.07	0.60	3.00	7.00	12.00	18.00	24.00
0.00	0	13	24	9	3	0	0
11.25	0	9	22	16	4	2	0
33.75	0	21	26	5	1	0	0
56.25	0	7	15	5	0	0	0
78.75	0	4	7	5	0	0	0
101.25	1	8	19	15	1	0	0
123.75	0	7	32	20	5	0	0
146.25	0	10	48	58	11	0	0
168.75	2	11	16	45	31	4	1
191.25	0	7	10	5	5	0	0
213.75	1	2	5	4	2	1	0
236.25	0	5	12	3	4	2	0
258.75	1	3	4	5	1	4	0
281.25	0	1	4	1	1	3	0
303.75	0	7	4	1	3	2	0
326.25	0	8	7	5	0	0	0

NRC CATEGORY B

deg	MPH						
	0.07	0.60	3.00	7.00	12.00	18.00	24.00
0.00	0	0	1	1	1	0	0
11.25	0	0	2	1	0	1	0
33.75	0	2	4	1	0	0	0
56.25	0	0	2	3	0	0	0
78.75	0	2	0	1	0	0	0
101.25	0	0	2	2	0	0	0
123.75	1	1	1	1	0	0	0
146.25	0	0	4	2	0	0	0
168.75	0	0	5	1	4	0	0
191.25	0	1	0	1	2	0	0
213.75	0	2	0	0	1	0	0
236.25	0	0	1	2	1	0	0
258.75	0	1	1	0	0	1	0
281.25	0	2	2	1	0	2	0
303.75	0	1	2	3	2	1	1
326.25	0	2	1	2	0	0	0

NRC CATEGORY C

deg	MPH						
	0.07	0.60	3.00	7.00	12.00	18.00	24.00
0.00	0	1	2	1	0	1	0
11.25	0	1	1	0	0	0	0
33.75	0	4	2	0	0	0	0
56.25	0	0	1	0	0	0	0
78.75	0	0	1	0	0	0	0
101.25	0	1	1	1	1	0	0
123.75	0	0	1	1	0	0	0
146.25	0	2	4	2	0	0	0
168.75	0	0	2	5	5	1	1
191.25	0	1	0	1	0	1	0
213.75	0	0	0	2	0	0	0
236.25	0	0	0	1	0	0	0
258.75	0	0	0	3	0	1	0
281.25	0	0	4	2	1	0	0
303.75	0	0	2	0	1	0	0
326.25	0	1	2	3	0	0	0

NRC CATEGORY D

deg	MPH						
	0.07	0.60	3.00	7.00	12.00	18.00	24.00
0.00	0	2	3	4	9	0	0
11.25	0	4	6	3	6	5	0
33.75	0	4	6	0	0	0	0
56.25	0	2	5	3	1	0	0
78.75	0	2	4	5	0	0	0
101.25	0	3	8	3	0	0	0
123.75	0	7	13	10	0	0	0
146.25	0	2	14	16	0	0	0
168.75	0	1	8	11	6	2	0
191.25	0	0	4	6	4	5	0
213.75	0	1	3	1	1	2	1
236.25	0	2	2	2	1	2	0
258.75	1	0	3	6	3	0	0
281.25	1	0	1	9	13	7	3
303.75	0	3	4	8	14	4	1
326.25	0	2	3	4	2	0	0

NRC CATEGORY E

deg	MPH						
	0.07	0.60	3.00	7.00	12.00	18.00	24.00
0.00	1	9	9	1	1	0	0
11.25	0	3	13	1	2	1	0
33.75	0	7	8	0	0	0	0
56.25	0	5	2	0	0	0	0
78.75	0	1	0	0	0	0	0
101.25	0	4	4	7	0	0	0
123.75	1	8	24	9	0	0	0
146.25	0	6	18	28	4	0	0
168.75	1	5	14	12	3	0	0
191.25	0	9	7	6	2	2	1
213.75	0	9	13	4	3	1	0
236.25	1	6	3	7	0	0	0
258.75	0	5	8	2	3	0	0
281.25	0	7	15	39	28	2	0
303.75	0	8	20	22	19	0	0
326.25	0	8	16	5	0	0	0

NRC CATEGORY F

deg	MPH						
	0.07	0.60	3.00	7.00	12.00	18.00	24.00
0.00	1	2	7	0	0	0	0
11.25	0	9	5	0	0	0	0
33.75	0	13	10	2	0	0	0
56.25	0	7	2	1	0	0	0
78.75	1	5	2	0	0	0	0
101.25	2	4	2	0	0	0	0
123.75	1	7	23	14	0	0	0
146.25	2	12	41	27	0	0	0
168.75	2	5	29	4	1	0	0
191.25	0	7	6	2	0	0	0
213.75	1	3	3	0	0	0	0
236.25	0	0	3	2	0	0	0
258.75	0	4	5	0	0	0	0
281.25	0	4	7	7	0	0	0
303.75	2	7	13	7	0	0	0
326.25	0	8	12	3	0	0	0

NRC CATEGORY G

	MPH						
deg	0.07	0.60	3.00	7.00	12.00	18.00	24.00
0.00	2	15	7	0	0	0	0
11.25	2	21	9	0	0	0	0
33.75	1	15	15	1	0	0	0
56.25	0	6	0	0	0	0	0
78.75	0	2	0	0	0	0	0
101.25	1	4	2	0	0	0	0
123.75	0	2	8	0	0	0	0
146.25	1	7	18	5	0	0	0
168.75	1	1	12	2	0	0	0
191.25	0	1	2	3	0	0	0
213.75	2	2	4	1	0	0	0
236.25	2	0	1	0	0	0	0
258.75	0	1	0	0	0	0	0
281.25	0	3	1	0	0	0	0
303.75	1	2	7	4	0	0	0
326.25	0	15	11	2	0	0	0

Table 5-6 3rd Quarter 2000, 245 FT AGL

JOINT FREQUENCY DISTRIBUTION FOR THE TIME PERIOD FROM HOUR 00 ON 07/01/00 TO HOUR 23 ON 09/30/00. The total hours are 2208 (2172 read and 36 missing).

NRC CATEGORY A

deg	MPH						
	0.07	0.60	3.00	7.00	12.00	18.00	24.00
0.00	1	2	14	7	4	0	0
11.25	1	8	22	13	4	5	1
33.75	0	7	12	14	1	1	0
56.25	0	9	9	8	1	0	0
78.75	0	4	8	7	0	0	0
101.25	0	6	14	16	1	0	0
123.75	0	5	14	17	8	1	0
146.25	0	8	33	35	4	3	0
168.75	0	5	29	67	21	1	0
191.25	0	2	15	23	45	6	4
213.75	0	5	12	2	6	1	0
236.25	1	2	10	3	2	2	2
258.75	0	2	8	2	4	3	2
281.25	0	5	7	3	2	0	1
303.75	0	6	5	0	1	2	5
326.25	0	5	4	4	2	0	0

NRC CATEGORY B

deg	MPH						
	0.07	0.60	3.00	7.00	12.00	18.00	24.00
0.00	0	0	0	0	0	0	0
11.25	0	1	1	0	1	2	0
33.75	0	1	1	1	0	0	0
56.25	0	0	2	0	0	0	0
78.75	0	0	0	4	0	0	0
101.25	0	0	1	2	0	0	0
123.75	0	1	2	0	2	0	0
146.25	0	1	1	2	0	0	0
168.75	0	1	5	3	0	0	0
191.25	0	0	3	1	4	1	0
213.75	0	2	0	0	2	1	0
236.25	0	1	0	1	0	1	0
258.75	0	0	1	1	1	0	1
281.25	0	2	3	0	1	0	1
303.75	1	0	2	2	0	2	2
326.25	0	1	1	4	2	0	0

NRC CATEGORY C

deg	MPH						
	0.07	0.60	3.00	7.00	12.00	18.00	24.00
0.00	0	0	0	2	1	0	0
11.25	0	0	1	1	0	0	1
33.75	0	1	2	1	0	0	0
56.25	0	0	1	0	0	0	0
78.75	0	0	0	2	0	0	0
101.25	0	0	0	0	1	0	0
123.75	0	2	0	2	1	0	0
146.25	0	1	0	2	0	0	0
168.75	0	0	3	4	2	0	0
191.25	0	0	0	4	3	5	1
213.75	0	0	0	0	0	0	0
236.25	0	0	1	0	3	0	0
258.75	0	0	0	0	0	1	0
281.25	0	0	1	2	3	1	0
303.75	0	0	1	1	1	1	0
326.25	0	2	3	3	0	0	0

NRC CATEGORY D

deg	MPH						
	0.07	0.60	3.00	7.00	12.00	18.00	24.00
0.00	0	5	4	3	7	1	0
11.25	0	1	3	5	2	4	9
33.75	0	3	2	0	0	0	0
56.25	1	0	1	2	0	0	0
78.75	0	1	3	5	1	0	0
101.25	0	3	2	7	2	0	0
123.75	0	0	6	10	2	0	0
146.25	0	3	8	6	2	0	0
168.75	0	0	9	17	4	0	0
191.25	0	2	5	12	8	7	1
213.75	0	2	4	3	4	2	7
236.25	0	3	2	1	0	0	3
258.75	1	0	5	5	4	2	0
281.25	0	0	0	2	3	12	6
303.75	0	0	2	2	10	12	20
326.25	0	0	2	1	2	1	0

NRC CATEGORY E

deg	MPH						
	0.07	0.60	3.00	7.00	12.00	18.00	24.00
0.00	0	1	6	5	0	0	0
11.25	0	1	2	2	1	1	3
33.75	0	0	4	0	1	0	0
56.25	0	0	2	2	0	0	0
78.75	1	0	2	1	0	0	0
101.25	0	0	5	0	0	0	0
123.75	0	1	4	4	1	0	0
146.25	1	1	9	18	8	0	0
168.75	0	2	12	18	15	2	0
191.25	0	3	2	15	12	5	0
213.75	0	1	5	4	4	4	5
236.25	0	3	10	8	5	2	0
258.75	0	4	7	13	5	4	0
281.25	0	1	12	12	23	24	7
303.75	0	3	12	27	34	36	7
326.25	0	0	9	16	5	0	0

NRC CATEGORY F

deg	MPH						
	0.07	0.60	3.00	7.00	12.00	18.00	24.00
0.00	0	5	8	3	0	0	0
11.25	0	3	4	1	0	0	0
33.75	0	1	1	2	2	0	0
56.25	0	3	0	0	1	0	0
78.75	0	2	5	1	0	0	0
101.25	0	2	3	0	0	0	0
123.75	0	3	9	1	1	0	0
146.25	0	4	12	14	4	0	0
168.75	0	3	18	35	15	0	0
191.25	0	3	17	15	9	1	0
213.75	0	5	12	3	1	0	0
236.25	0	1	9	4	0	0	0
258.75	1	0	8	2	2	0	0
281.25	0	2	4	6	7	0	0
303.75	1	3	4	15	17	3	0
326.25	0	2	7	9	10	0	0

NRC CATEGORY G

deg	MPH						
	0.07	0.60	3.00	7.00	12.00	18.00	24.00
0.00	1	1	11	4	0	0	0
11.25	0	3	4	4	0	0	0
33.75	0	2	9	3	1	1	0
56.25	0	0	7	2	1	0	0
78.75	1	5	4	0	0	0	0
101.25	1	2	2	0	0	0	0
123.75	0	4	2	1	1	0	0
146.25	0	6	9	7	5	0	0
168.75	0	3	12	8	1	0	0
191.25	0	5	6	7	1	0	0
213.75	0	4	7	2	1	2	0
236.25	0	3	3	3	0	0	0
258.75	0	3	1	3	0	0	0
281.25	0	1	1	2	2	0	0
303.75	0	1	3	1	4	0	0
326.25	0	3	9	8	7	0	0

Table 5-7 4th Quarter 2000, 33 FT AGL

JOINT FREQUENCY DISTRIBUTION FOR THE TIME PERIOD FROM HOUR 00 ON 10/1/00 TO HOUR 23 ON 12/31/00. The total hours are 2208, (2014 read and 194 missing).

NRC CATEGORY A

deg	MPH						
	0.07	0.60	3.00	7.00	12.00	18.00	24.00
0.00	3	25	71	42	7	0	0
11.25	2	23	42	18	2	0	0
33.75	0	16	23	3	0	0	0
56.25	0	7	1	2	0	0	0
78.75	0	0	2	0	0	0	0
101.25	1	8	2	0	0	0	0
123.75	1	7	5	5	0	0	0
146.25	1	9	33	20	1	0	0
168.75	1	15	29	35	6	0	0
191.25	1	17	13	9	7	0	0
213.75	3	11	6	1	5	1	0
236.25	2	15	6	2	4	0	1
258.75	0	4	20	5	1	3	4
281.25	2	16	28	20	7	6	0
303.75	5	23	62	42	6	2	0
326.25	0	20	75	34	4	0	0

NRC CATEGORY B

deg	MPH						
	0.07	0.60	3.00	7.00	12.00	18.00	24.00
0.00	0	3	5	1	0	0	0
11.25	0	1	1	0	0	0	0
33.75	0	1	0	0	0	0	0
56.25	0	0	0	0	0	0	0
78.75	0	0	0	0	0	0	0
101.25	0	0	1	0	0	0	0
123.75	0	0	0	0	0	0	0
146.25	0	1	3	6	2	0	0
168.75	0	1	0	2	2	0	0
191.25	0	0	2	0	0	0	0
213.75	0	1	1	0	0	0	0
236.25	0	1	1	1	0	0	0
258.75	0	0	0	0	0	0	0
281.25	0	2	1	1	0	0	0
303.75	0	2	5	3	1	0	0
326.25	0	1	4	2	1	0	0

NRC CATEGORY C

deg	MPH						
	0.07	0.60	3.00	7.00	12.00	18.00	24.00
0.00	0	3	2	1	0	0	0
11.25	0	0	1	0	0	0	0
33.75	0	0	1	0	0	0	0
56.25	0	0	1	0	0	0	0
78.75	0	0	0	0	0	0	0
101.25	0	0	0	0	0	0	0
123.75	0	0	0	0	0	0	0
146.25	0	0	2	7	0	0	0
168.75	0	0	1	0	3	0	0
191.25	0	0	0	0	0	0	0
213.75	0	1	0	0	0	0	0
236.25	0	0	1	0	0	0	1
258.75	0	1	1	0	0	1	0
281.25	0	0	2	0	1	0	0
303.75	0	0	2	0	1	0	0
326.25	0	1	3	4	0	0	0

NRC CATEGORY D

deg	MPH						
	0.07	0.60	3.00	7.00	12.00	18.00	24.00
0.00	1	8	6	1	0	0	0
11.25	0	4	10	0	0	0	0
33.75	1	3	6	4	0	0	0
56.25	0	4	0	0	0	0	0
78.75	0	0	0	0	0	0	0
101.25	0	2	0	0	0	0	0
123.75	0	1	1	4	0	0	0
146.25	0	2	11	7	1	0	0
168.75	0	5	11	10	3	0	0
191.25	0	2	4	2	1	2	1
213.75	1	4	3	0	2	1	0
236.25	0	3	5	1	0	2	0
258.75	1	3	3	1	1	0	0
281.25	0	7	2	7	3	0	0
303.75	0	9	6	12	3	1	0
326.25	0	9	11	5	0	0	0

NRC CATEGORY E

deg	MPH						
	0.07	0.60	3.00	7.00	12.00	18.00	24.00
0.00	1	12	12	1	0	0	0
11.25	1	10	5	0	0	0	0
33.75	1	2	7	2	0	0	0
56.25	1	3	1	1	0	0	0
78.75	0	0	0	0	0	0	0
101.25	0	2	0	0	0	0	0
123.75	0	3	5	0	0	0	0
146.25	0	3	19	22	0	0	0
168.75	0	5	21	8	2	0	0
191.25	0	7	11	1	0	0	0
213.75	1	4	4	0	1	0	0
236.25	0	6	8	3	0	0	0
258.75	0	7	2	5	1	0	0
281.25	0	8	4	14	4	0	0
303.75	3	18	17	20	3	0	0
326.25	2	16	23	8	0	0	0

NRC CATEGORY F

deg	MPH						
	0.07	0.60	3.00	7.00	12.00	18.00	24.00
0.00	1	13	17	0	0	0	0
11.25	0	17	15	0	0	0	0
33.75	0	4	11	6	0	0	0
56.25	1	2	1	0	0	0	0
78.75	0	1	0	0	0	0	0
101.25	0	2	0	0	0	0	0
123.75	0	0	0	0	0	0	0
146.25	0	3	3	7	0	0	0
168.75	0	7	14	5	1	0	0
191.25	0	3	9	0	1	1	0
213.75	1	5	4	0	0	0	0
236.25	1	6	0	2	0	0	0
258.75	0	4	1	4	0	0	0
281.25	1	11	4	1	2	0	0
303.75	0	17	15	12	4	0	0
326.25	1	12	36	2	0	0	0

NRC CATEGORY G

deg	MPH						
	0.07	0.60	3.00	7.00	12.00	18.00	24.00
0.00	1	3	11	0	0	0	0
11.25	0	5	5	0	0	0	0
33.75	0	1	5	0	0	0	0
56.25	0	0	2	1	0	0	0
78.75	0	0	0	0	0	0	0
101.25	0	0	0	0	0	0	0
123.75	0	4	0	0	0	0	0
146.25	0	2	1	0	1	0	0
168.75	0	3	3	0	0	0	0
191.25	0	1	0	0	0	0	0
213.75	2	1	0	0	0	0	0
236.25	0	0	0	1	0	0	0
258.75	1	0	2	1	0	0	0
281.25	0	0	1	0	0	0	0
303.75	0	1	3	2	0	0	0
326.25	0	2	17	2	0	0	0

Table 5-8 4th Quarter 2000, 245 FT AGL

JOINT FREQUENCY DISTRIBUTION FOR THE TIME PERIOD FROM HOUR 00 ON 01/01/00 TO HOUR 23 ON 12/31/00. The total hours are 8784, (8489 read and 295 missing).

NRC CATEGORY A

deg	MPH						
	0.07	0.60	3.00	7.00	12.00	18.00	24.00
0.00	3	55	101	93	34	3	6
11.25	2	39	105	56	12	6	1
33.75	0	22	43	46	3	1	0
56.25	0	16	23	16	2	0	0
78.75	0	10	15	10	0	0	0
101.25	0	10	22	22	3	0	0
123.75	0	11	23	33	13	3	0
146.25	0	20	59	73	9	3	0
168.75	2	13	53	132	30	2	0
191.25	2	6	37	50	91	12	4
213.75	1	11	23	24	29	9	5
236.25	2	7	23	14	9	9	10
258.75	0	8	19	15	14	6	14
281.25	1	11	35	16	19	8	3
303.75	2	18	35	39	26	11	10
326.25	0	21	61	67	44	3	0

NRC CATEGORY B

deg	MPH						
	0.07	0.60	3.00	7.00	12.00	18.00	24.00
0.00	0	2	7	12	4	0	0
11.25	0	5	9	3	1	2	0
33.75	0	4	5	3	0	0	0
56.25	0	0	4	0	0	0	0
78.75	0	0	0	4	0	0	0
101.25	0	2	1	2	0	0	0
123.75	0	1	2	1	3	0	0
146.25	0	2	6	8	3	1	0
168.75	0	1	11	8	3	2	0
191.25	0	2	6	3	13	3	0
213.75	0	2	3	4	6	4	2
236.25	0	1	2	4	9	4	4
258.75	0	0	1	2	4	2	2
281.25	0	3	4	2	2	0	2
303.75	1	3	4	5	1	4	6
326.25	0	2	5	6	6	2	0

NRC CATEGORY C

deg	MPH						
	0.07	0.60	3.00	7.00	12.00	18.00	24.00
0.00	0	1	10	7	4	0	2
11.25	0	1	7	3	0	0	1
33.75	0	3	5	4	1	0	0
56.25	0	1	3	0	0	0	0
78.75	0	1	0	2	0	0	0
101.25	0	0	1	0	1	0	0
123.75	0	2	3	4	4	0	0
146.25	0	5	5	4	2	0	0
168.75	0	2	5	8	7	3	0
191.25	0	1	4	8	11	7	2
213.75	0	2	2	3	1	6	3
236.25	0	1	1	1	8	9	3
258.75	0	1	1	3	1	3	1
281.25	0	1	2	3	3	5	0
303.75	1	2	3	5	2	2	3
326.25	0	3	10	6	4	1	0

NRC CATEGORY D

deg	MPH						
	0.07	0.60	3.00	7.00	12.00	18.00	24.00
0.00	0	18	33	20	17	3	7
11.25	1	6	23	19	3	4	9
33.75	0	12	18	6	4	0	0
56.25	1	3	10	5	1	0	0
78.75	1	3	4	6	1	0	0
101.25	1	4	7	9	5	0	0
123.75	0	5	12	21	8	0	0
146.25	0	8	22	39	14	0	0
168.75	0	8	42	47	23	3	0
191.25	0	15	20	45	32	8	4
213.75	0	7	15	14	14	11	16
236.25	0	12	11	12	17	15	11
258.75	1	7	16	12	14	18	6
281.25	0	5	13	13	17	24	21
303.75	1	2	15	12	24	26	36
326.25	0	5	23	30	15	11	0

NRC CATEGORY E

deg	MPH						
	0.07	0.60	3.00	7.00	12.00	18.00	24.00
0.00	1	11	50	43	16	1	1
11.25	0	13	27	29	4	1	3
33.75	1	7	18	8	4	1	0
56.25	0	9	14	7	0	0	0
78.75	1	7	8	3	2	0	0
101.25	1	9	14	3	1	0	0
123.75	0	11	18	26	13	2	0
146.25	2	8	41	63	35	5	0
168.75	0	16	47	68	52	8	1
191.25	0	13	36	49	39	22	16
213.75	0	18	32	33	32	31	17
236.25	3	11	36	32	13	14	11
258.75	2	19	29	40	29	22	14
281.25	0	17	57	62	115	98	33
303.75	0	14	57	105	152	77	18
326.25	0	7	50	89	40	9	0

NRC CATEGORY F

deg	MPH						
	0.07	0.60	3.00	7.00	12.00	18.00	24.00
0.00	1	16	53	24	3	0	1
11.25	0	8	37	18	1	0	0
33.75	1	6	22	21	4	0	0
56.25	2	6	8	7	2	0	0
78.75	1	9	9	4	1	0	0
101.25	1	6	8	0	0	0	0
123.75	0	11	21	6	4	0	0
146.25	0	12	45	39	22	1	0
168.75	0	13	43	80	44	4	1
191.25	0	7	42	41	36	8	2
213.75	0	11	39	26	19	10	4
236.25	0	12	29	15	3	2	1
258.75	1	12	24	6	16	4	0
281.25	0	8	21	24	35	13	3
303.75	1	11	20	58	71	18	1
326.25	0	10	52	55	42	7	0

NRC CATEGORY G

deg	MPH						
	0.07	0.60	3.00	7.00	12.00	18.00	24.00
0.00	2	6	29	14	2	0	0
11.25	0	13	17	7	1	0	0
33.75	0	7	20	12	3	2	0
56.25	0	1	17	4	2	0	0
78.75	1	7	11	1	1	0	0
101.25	2	5	5	0	0	0	0
123.75	0	10	9	2	2	0	0
146.25	1	9	40	29	13	1	0
168.75	1	20	50	35	5	0	0
191.25	0	9	32	22	6	0	0
213.75	0	16	35	23	3	3	0
236.25	0	7	13	11	5	0	0
258.75	1	7	14	5	3	1	0
281.25	1	4	5	9	13	6	0
303.75	2	3	14	19	55	5	0
326.25	0	9	36	36	24	1	0

Table 5-9 Year 2000, 33 FT AGL

JOINT FREQUENCY DISTRIBUTION FOR THE TIME PERIOD FROM HOUR 00 ON 01/01/00 TO HOUR 23 ON 12/31/00. The total hours are 8784, (8560 read and 224 missing).

NRC CATEGORY A

deg	MPH						
	0.07	0.60	3.00	7.00	12.00	18.00	24.00
0.00	3	42	105	60	12	0	0
11.25	2	38	80	54	6	2	0
33.75	1	41	60	14	1	0	0
56.25	0	16	19	7	0	0	0
78.75	1	9	10	6	0	0	0
101.25	3	22	30	21	2	0	0
123.75	1	15	51	47	6	0	0
146.25	1	21	106	108	14	0	0
168.75	3	32	73	102	59	4	1
191.25	1	28	38	28	25	2	0
213.75	4	16	22	19	19	9	1
236.25	2	23	24	12	15	8	02
258.75	1	11	29	20	3	8	6
281.25	2	23	36	25	17	14	2
303.75	5	37	75	54	20	7	0
326.25	0	31	94	48	9	0	0

NRC CATEGORY B

deg	MPH						
	0.07	0.60	3.00	7.00	12.00	18.00	24.00
0.00	0	4	8	3	1	0	0
11.25	0	4	8	1	0	1	0
33.75	0	3	7	2	0	0	0
56.25	0	0	3	3	0	0	0
78.75	0	2	0	1	0	0	0
101.25	0	0	3	2	0	0	0
123.75	1	1	4	5	0	0	0
146.25	0	3	13	12	3	0	0
168.75	0	2	9	9	11	0	0
191.25	0	2	3	7	7	1	0
213.75	0	3	3	5	7	1	1
236.25	0	1	2	4	5	3	1
258.75	0	2	2	2	1	1	0
281.25	0	6	4	3	1	4	0
303.75	0	5	11	8	5	2	3
326.25	0	4	6	9	2	0	0

NRC CATEGORY C

deg	MPH						
	0.07	0.60	3.00	7.00	12.00	18.00	24.00
0.00	0	6	10	3	0	1	0
11.25	0	5	6	0	0	0	0
33.75	0	5	6	0	1	0	0
56.25	0	1	2	0	0	0	0
78.75	0	0	1	0	0	0	0
101.25	1	3	2	2	2	0	0
123.75	0	1	6	5	0	0	0
146.25	1	3	8	13	1	0	0
168.75	0	1	7	12	13	2	1
191.25	0	2	1	6	4	4	1
213.75	1	3	1	3	8	3	0
236.25	1	0	1	5	5	2	1
258.75	0	2	1	4	1	3	0
281.25	0	0	7	4	4	1	0
303.75	0	1	6	2	4	3	0
326.25	0	4	13	8	1	0	0

NRC CATEGORY D

deg	MPH						
	0.07	0.60	3.00	7.00	12.00	18.00	24.00
0.00	1	12	27	12	9	0	0
11.25	2	18	28	6	6	5	0
33.75	2	9	17	4	0	0	0
56.25	2	9	7	4	1	0	0
78.75	1	6	7	7	0	0	0
101.25	1	7	10	9	0	0	0
123.75	1	10	29	35	1	0	0
146.25	1	6	64	61	2	0	0
168.75	1	18	45	53	15	3	0
191.25	1	10	21	15	19	10	2
213.75	2	10	14	11	21	9	2
236.25	1	8	15	13	19	9	1
258.75	4	10	14	13	21	2	0
281.25	1	13	11	28	33	20	4
303.75	0	16	24	32	33	13	2
326.25	1	15	33	31	5	1	0

NRC CATEGORY E

deg	MPH						
	0.07	0.60	3.00	7.00	12.00	18.00	24.00
0.00	3	38	40	9	1	0	0
11.25	6	30	29	9	2	1	0
33.75	1	14	19	2	1	0	0
56.25	2	11	10	3	0	0	0
78.75	0	7	3	1	0	0	0
101.25	2	17	10	16	2	0	0
123.75	4	21	62	52	5	1	0
146.25	2	24	108	95	7	3	0
168.75	1	30	81	67	21	8	2
191.25	3	28	45	29	36	8	4
213.75	5	25	47	18	13	6	1
236.25	4	26	43	22	9	7	2
258.75	3	27	35	75	20	0	0
281.25	5	43	75	184	94	11	1
303.75	4	49	122	115	46	2	0
326.25	3	41	95	39	4	1	0

NRC CATEGORY F

deg	MPH						
	0.07	0.60	3.00	7.00	12.00	18.00	24.00
0.00	5	32	53	0	0	0	0
11.25	0	34	34	1	0	0	0
33.75	0	28	26	10	0	0	0
56.25	1	14	3	1	0	0	0
78.75	1	9	2	2	0	0	0
101.25	3	9	6	3	0	0	0
123.75	3	12	38	37	0	0	0
146.25	4	29	105	91	6	0	0
168.75	4	28	73	38	4	2	0
191.25	1	29	33	16	11	3	0
213.75	4	18	16	4	3	0	0
236.25	2	14	9	15	0	0	0
258.75	3	29	18	19	1	0	0
281.25	2	31	44	33	5	0	0
303.75	5	39	96	43	4	0	0
326.25	2	47	92	8	0	0	0

NRC CATEGORY G

deg	MPH						
	0.07	0.60	3.00	7.00	12.00	18.00	24.00
0.00	4	36	31	1	0	0	0
11.25	2	55	27	1	0	0	0
33.75	4	25	26	3	0	0	0
56.25	2	8	2	1	0	0	0
78.75	1	7	0	0	0	0	0
101.25	3	6	3	1	0	0	0
123.75	1	15	17	5	0	0	0
146.25	1	18	68	26	1	0	0
168.75	2	11	50	12	0	0	0
191.25	3	12	13	15	0	0	0
213.75	4	19	10	3	0	0	0
236.25	3	17	6	4	0	0	0
258.75	2	9	10	1	1	0	0
281.25	4	27	27	11	0	0	0
303.75	2	24	60	16	0	0	0
326.25	2	37	56	7	0	0	0

Table 5-10 Year 2000, 245 FT AGL

JOINT FREQUENCY DISTRIBUTION FOR THE TIME PERIOD FROM HOUR 00 ON 01/01/00 TO HOUR 23 ON 12/31/00. The total hours are 8784, (8489 read and 295 missing).

NRC CATEGORY A

deg	MPH						
	0.07	0.60	3.00	7.00	12.00	18.00	24.00
0.00	3	55	101	93	34	3	6
11.25	2	39	105	56	12	6	1
33.75	0	22	43	46	3	1	0
56.25	0	16	23	16	2	0	0
78.75	0	10	15	10	0	0	0
101.25	0	10	22	22	3	0	0
123.75	0	11	23	33	13	3	0
146.25	0	20	59	73	9	3	0
168.75	2	13	53	132	30	2	0
191.25	2	6	37	50	91	12	4
213.75	1	11	23	24	29	9	5
236.25	2	7	23	14	9	9	10
258.75	0	8	19	15	14	6	14
281.25	1	11	35	16	19	8	3
303.75	2	18	35	39	26	11	10
326.25	0	21	61	67	44	3	0

NRC CATEGORY B

deg	MPH						
	0.07	0.60	3.00	7.00	12.00	18.00	24.00
0.00	0	2	7	12	4	0	0
11.25	0	5	9	3	1	2	0
33.75	0	4	5	3	0	0	0
56.25	0	0	4	0	0	0	0
78.75	0	0	0	4	0	0	0
101.25	0	2	1	2	0	0	0
123.75	0	1	2	1	3	0	0
146.25	0	2	6	8	3	1	0
168.75	0	1	11	8	3	2	0
191.25	0	2	6	3	13	3	0
213.75	0	2	3	4	6	4	2
236.25	0	1	2	4	9	4	4
258.75	0	0	1	2	4	2	2
281.25	0	3	4	2	2	0	2
303.75	1	3	4	5	1	4	6
326.25	0	2	5	6	6	2	0

NRC CATEGORY C

deg	MPH						
	0.07	0.60	3.00	7.00	12.00	18.00	24.00
0.00	0	1	10	7	4	0	2
11.25	0	1	7	3	0	0	1
33.75	0	3	5	4	1	0	0
56.25	0	1	3	0	0	0	0
78.75	0	1	0	2	0	0	0
101.25	0	0	1	0	1	0	0
123.75	0	2	3	4	4	0	0
146.25	0	5	5	4	2	0	0
168.75	0	2	5	8	7	3	0
191.25	0	1	4	8	11	7	2
213.75	0	2	2	3	1	6	3
236.25	0	1	1	1	8	9	3
258.75	0	1	1	3	1	3	1
281.25	0	1	2	3	3	5	0
303.75	1	2	3	5	2	2	3
326.25	0	3	10	6	4	1	0

NRC CATEGORY D

deg	MPH						
	0.07	0.60	3.00	7.00	12.00	18.00	24.00
0.00	0	18	33	20	17	3	7
11.25	1	6	23	19	3	4	9
33.75	0	12	18	6	4	0	0
56.25	1	3	10	5	1	0	0
78.75	1	3	4	6	1	0	0
101.25	1	4	7	9	5	0	0
123.75	0	5	12	21	8	0	0
146.25	0	8	22	39	14	0	0
168.75	0	8	42	47	23	3	0
191.25	0	15	20	45	32	8	4
213.75	0	7	15	14	14	11	16
236.25	0	12	11	12	17	15	11
258.75	1	7	16	12	14	18	6
281.25	0	5	13	13	17	24	21
303.75	1	2	15	12	24	26	36
326.25	0	5	23	30	15	11	0

NRC CATEGORY E

deg	MPH						
	0.07	0.60	3.00	7.00	12.00	18.00	24.00
0.00	1	11	50	43	16	1	1
11.25	0	13	27	29	4	1	3
33.75	1	7	18	8	4	1	0
56.25	0	9	14	7	0	0	0
78.75	1	7	8	3	2	0	0
101.25	1	9	14	3	1	0	0
123.75	0	11	18	26	13	2	0
146.25	2	8	41	63	35	5	0
168.75	0	16	47	68	52	8	1
191.25	0	13	36	49	39	22	16
213.75	0	18	32	33	32	31	17
236.25	3	11	36	32	13	14	11
258.75	2	19	29	40	29	22	14
281.25	0	17	57	62	115	98	33
303.75	0	14	57	105	152	77	18
326.25	0	7	50	89	40	9	0

NRC CATEGORY F

deg	MPH						
	0.07	0.60	3.00	7.00	12.00	18.00	24.00
0.00	1	16	53	24	3	0	1
11.25	0	8	37	18	1	0	0
33.75	1	6	22	21	4	0	0
56.25	2	6	8	7	2	0	0
78.75	1	9	9	4	1	0	0
101.25	1	6	8	0	0	0	0
123.75	0	11	21	6	4	0	0
146.25	0	12	45	39	22	1	0
168.75	0	13	43	80	44	4	1
191.25	0	7	42	41	36	8	2
213.75	0	11	39	26	19	10	4
236.25	0	12	29	15	3	2	1
258.75	1	12	24	6	16	4	0
281.25	0	8	21	24	35	13	3
303.75	1	11	20	58	71	18	1
326.25	0	10	52	55	42	7	0

NRC CATEGORY G

deg	MPH						
	0.07	0.60	3.00	7.00	12.00	18.00	24.00
0.00	2	6	29	14	2	0	0
11.25	0	13	17	7	1	0	0
33.75	0	7	20	12	3	2	0
56.25	0	1	17	4	2	0	0
78.75	1	7	11	1	1	0	0
101.25	2	5	5	0	0	0	0
123.75	0	10	9	2	2	0	0
146.25	1	9	40	29	13	1	0
168.75	1	20	50	35	5	0	0
191.25	0	9	32	22	6	0	0
213.75	0	16	35	23	3	3	0
236.25	0	7	13	11	5	0	0
258.75	1	7	14	5	3	1	0
281.25	1	4	5	9	13	6	0
303.75	2	3	14	19	55	5	0
326.25	0	9	36	36	24	1	0

6.0 DOSE ASSESSMENT -- IMPACT ON MAN

Liquid Effluents - There were no radioactive liquid discharges from Columbia Generating Station in 2000.

Table 6-1 lists the maximum doses to an individual by calendar quarter, along with the cumulative total body and maximum organ values. Doses by calendar quarters to the average exposed individual are listed in Table 6-2. The 50-mile population doses by calendar quarter are listed in Table 6-3. Table 6-4 provides annual doses to the average individual and 50-mile population doses from liquid effluents. All doses would have been calculated using the NRC LADTAP II computer code if there had been any releases.

Gaseous Effluents - The NRC GASPAR II computer code was used to calculate doses at and beyond the site boundary. Table 6-5 lists the annual 50-mile dose using values obtained from the ALARA annual integrated population dose summary (person-rem). Table 6-5 also provides the annual individual doses associated with each pathway. These values were obtained by dividing the ALARA integrated dose (person-rem) by the estimated 50-mile population (252,356 for year 1987) and converting to mrem. The GASPAR II runs use quarterly and annual meteorological data and site specific input parameters.

The Columbia Generating Station Visitor Center was evaluated for assessment of radiation doses to "Members of the Public" due to their activities within the site boundary. The ODCM assumes an eight (8) hour per year occupancy by a member of the public at the Visitor Center and exposure to the plume, ground shine, and inhalation pathways. The dose assessment resulted in an annual calculated total body dose of $5.42E-02$ mrem. The annual thyroid dose was $5.49E-02$ mrem and the maximum dose to any other organ was $5.96E-02$ mrem (skin). The beta air dose contribution was $4.80E-03$ mrad and the gamma air dose contribution was $1.36E-02$ mrad. Thermoluminescent dosimeters (TLD) at the Visitor Center measured an average of $1.12E-01$ mrem per eight-hour period (includes background radiation).

Periodically, Columbia Generating Station offers public tours of selected locations within the site boundary. Exposure to members of the public involves walking from the parking lot, to the west entrance of the power plant. The following calculation assumed an eight (8) hour per year exposure to the plume, ground shine, and inhalation pathways. The dose assessment resulted in an annual calculated total body dose of $2.75E-02$ mrem. The annual thyroid dose was $2.77E-02$ mrem and the maximum dose to any other organ was $2.78E-02$ mrem (skin). The beta air dose contribution was $3.01E-04$ mrad and the gamma air dose contribution was $8.53E-04$ mrad.

The highest calculated dose to a child living at locations identified in the most recent land use census was $2.47E-03$ mrem to the total body, $2.75E-03$ mrem to the thyroid, and $2.66E-03$ mrem to the skin. This location was at 4.1 miles in the ESE sector and contained a garden.

TLD stations at and beyond the site boundary showed no significant change in radiation levels compared to pre-operational (background) values.

Dose Tables

**Table 6-1 Maximum Individual Dose from Liquid Effluents
First and Second Quarters 2000**

1st Quarter*				
Pathway	Total Body (mrem/qtr)	Cumulative Total Body (mrem/yr)	Max. Organ (mrem/qtr)	Cumulative Max. Organ (mrem/yr)
Fishing	0.00E+00	0.00E+00	0.00E+00	0.00E+00
Drinking	0.00E+00	0.00E+00	0.00E+00	0.00E+00
Shoreline	0.00E+00	0.00E+00	0.00E+00	0.00E+00
Swimming	0.00E+00	0.00E+00	0.00E+00	0.00E+00
Boating	0.00E+00	0.00E+00	0.00E+00	0.00E+00
Vegetables	0.00E+00	0.00E+00	0.00E+00	0.00E+00
Leafy Veg.	0.00E+00	0.00E+00	0.00E+00	0.00E+00
Milk	0.00E+00	0.00E+00	0.00E+00	0.00E+00
Meat	0.00E+00	0.00E+00	0.00E+00	0.00E+00
Total	0.00E+00	0.00E+00	0.00E+00	0.00E+00

2nd Quarter*				
Pathway	Total Body (mrem/qtr)	Cumulative Total Body (mrem/yr)	Max. Organ (mrem/qtr)	Cumulative Max. Organ (mrem/yr)
Fishing	0.00E+00	0.00E+00	0.00E+00	0.00E+00
Drinking	0.00E+00	0.00E+00	0.00E+00	0.00E+00
Shoreline	0.00E+00	0.00E+00	0.00E+00	0.00E+00
Swimming	0.00E+00	0.00E+00	0.00E+00	0.00E+00
Boating	0.00E+00	0.00E+00	0.00E+00	0.00E+00
Vegetables	0.00E+00	0.00E+00	0.00E+00	0.00E+00
Leafy Veg.	0.00E+00	0.00E+00	0.00E+00	0.00E+00
Milk	0.00E+00	0.00E+00	0.00E+00	0.00E+00
Meat	0.00E+00	0.00E+00	0.00E+00	0.00E+00
Total	0.00E+00	0.00E+00	0.00E+00	0.00E+00

* Age Group - Adult: Maximum individual resides at Richland and fishes near the outfall area

**Table 6-1 Maximum Individual Doses from Liquid Effluents (Continued)
Third and Fourth Quarters 2000**

3rd Quarter*				
Pathway	Total Body (mrem/qtr)	Cumulative Total Body (mrem/yr)	Max. Organ (mrem/qtr)	Cumulative Max. Organ (mrem/yr)
Fishing	0.00E+00	0.00E+00	0.00E+00	0.00E+00
Drinking	0.00E+00	0.00E+00	0.00E+00	0.00E+00
Shoreline	0.00E+00	0.00E+00	0.00E+00	0.00E+00
Swimming	0.00E+00	0.00E+00	0.00E+00	0.00E+00
Boating	0.00E+00	0.00E+00	0.00E+00	0.00E+00
Vegetables	0.00E+00	0.00E+00	0.00E+00	0.00E+00
Leafy Veg.	0.00E+00	0.00E+00	0.00E+00	0.00E+00
Milk	0.00E+00	0.00E+00	0.00E+00	0.00E+00
Meat	0.00E+00	0.00E+00	0.00E+00	0.00E+00
Total	0.00E+00	0.00E+00	0.00E+00	0.00E+00

4th Quarter*				
Pathway	Total Body (mrem/qtr)	Cumulative Total Body (mrem/yr)	Max. Organ (mrem/qtr)	Cumulative Max. Organ (mrem/yr)
Fishing	0.00E+00	0.00E+00	0.00E+00	0.00E+00
Drinking	0.00E+00	0.00E+00	0.00E+00	0.00E+00
Shoreline	0.00E+00	0.00E+00	0.00E+00	0.00E+00
Swimming	0.00E+00	0.00E+00	0.00E+00	0.00E+00
Boating	0.00E+00	0.00E+00	0.00E+00	0.00E+00
Vegetables	0.00E+00	0.00E+00	0.00E+00	0.00E+00
Leafy Veg.	0.00E+00	0.00E+00	0.00E+00	0.00E+00
Milk	0.00E+00	0.00E+00	0.00E+00	0.00E+00
Meat	0.00E+00	0.00E+00	0.00E+00	0.00E+00
Total	0.00E+00	0.00E+00	0.00E+00	0.00E+00

* Age Group - Adult: Maximum individual resides at Richland and fishes near the outfall area

Table 6-2 Average Individual Dose from Liquid Effluents

Pathway	1st Quarter 2000		2nd Quarter 2000	
	Total Body (mrem)	Max. Organ (mrem)	Total Body (mrem)	Max. Organ (mrem)
Fishing	0.00E+00	0.00E+00	0.00E+00	0.00E+00
Drinking	0.00E+00	0.00E+00	0.00E+00	0.00E+00
Shoreline	0.00E+00	0.00E+00	0.00E+00	0.00E+00
Swimming	0.00E+00	0.00E+00	0.00E+00	0.00E+00
Boating	0.00E+00	0.00E+00	0.00E+00	0.00E+00
Vegetables*	0.00E+00	0.00E+00	0.00E+00	0.00E+00
Leafy Veg.*	0.00E+00	0.00E+00	0.00E+00	0.00E+00
Milk*	0.00E+00	0.00E+00	0.00E+00	0.00E+00
Meat*	0.00E+00	0.00E+00	0.00E+00	0.00E+00
Total	0.00E+00	0.00E+00	0.00E+00	0.00E+00

Pathway	3rd Quarter 2000		4th Quarter 2000	
	Total Body (mrem)	Max. Organ (mrem)	Total Body (mrem)	Max. Organ (mrem)
Fishing	0.00E+00	0.00E+00	0.00E+00	0.00E+00
Drinking	0.00E+00	0.00E+00	0.00E+00	0.00E+00
Shoreline	0.00E+00	0.00E+00	0.00E+00	0.00E+00
Swimming	0.00E+00	0.00E+00	0.00E+00	0.00E+00
Boating	0.00E+00	0.00E+00	0.00E+00	0.00E+00
Vegetables*	0.00E+00	0.00E+00	0.00E+00	0.00E+00
Leafy Veg.*	0.00E+00	0.00E+00	0.00E+00	0.00E+00
Milk*	0.00E+00	0.00E+00	0.00E+00	0.00E+00
Meat*	0.00E+00	0.00E+00	0.00E+00	0.00E+00
Total	0.00E+00	0.00E+00	0.00E+00	0.00E+00

* Total population ALARA doses divided by the total population served from irrigated production; converted to mrem

**Table 6-3 50-Mile Population Collective Dose from Liquid Effluents
By Quarter, 2000**

Pathway	1st Quarter		2nd Quarter	
	Total Body (person-rem)	Max. Organ (person-rem)	Total Body (person-rem)	Max. Organ (person-rem)
Fishing	0.00E+00	0.00E+00	0.00E+00	0.00E+00
Drinking	0.00E+00	0.00E+00	0.00E+00	0.00E+00
Shoreline	0.00E+00	0.00E+00	0.00E+00	0.00E+00
Swimming	0.00E+00	0.00E+00	0.00E+00	0.00E+00
Boating	0.00E+00	0.00E+00	0.00E+00	0.00E+00
Vegetables	0.00E+00	0.00E+00	0.00E+00	0.00E+00
Leafy Veg.	0.00E+00	0.00E+00	0.00E+00	0.00E+00
Milk	0.00E+00	0.00E+00	0.00E+00	0.00E+00
Meat	0.00E+00	0.00E+00	0.00E+00	0.00E+00
Total	0.00E+00	0.00E+00	0.00E+00	0.00E+00

Pathway	3rd Quarter		4th Quarter	
	Total Body (person-rem)	Max. Organ (person-rem)	Total Body (person-rem)	Max. Organ (person-rem)
Fishing	0.00E+00	0.00E+00	0.00E+00	0.00E+00
Drinking	0.00E+00	0.00E+00	0.00E+00	0.00E+00
Shoreline	0.00E+00	0.00E+00	0.00E+00	0.00E+00
Swimming	0.00E+00	0.00E+00	0.00E+00	0.00E+00
Boating	0.00E+00	0.00E+00	0.00E+00	0.00E+00
Vegetables	0.00E+00	0.00E+00	0.00E+00	0.00E+00
Leafy Veg.	0.00E+00	0.00E+00	0.00E+00	0.00E+00
Milk	0.00E+00	0.00E+00	0.00E+00	0.00E+00
Meat	0.00E+00	0.00E+00	0.00E+00	0.00E+00
Total	0.00E+00	0.00E+00	0.00E+00	0.00E+00

Table 6-4 Annual Collective Dose from Liquid Effluents

50-mile population collective dose in 2000

Pathway	Total Body (person-rem)	Max. Organ (person-rem)
Fishing	0.00E+00	0.00E+00
Drinking	0.00E+00	0.00E+00
Shoreline	0.00E+00	0.00E+00
Swimming	0.00E+00	0.00E+00
Boating	0.00E+00	0.00E+00
Vegetables	0.00E+00	0.00E+00
Leafy Veg.	0.00E+00	0.00E+00
Milk	0.00E+00	0.00E+00
Meat	0.00E+00	0.00E+00
Total	0.00E+00	0.00E+00

Average individual dose in 2000

Pathway	Total Body (mrem)	Max. Organ (mrem)
Fishing	0.00E+00	0.00E+00
Drinking	0.00E+00	0.00E+00
Shoreline	0.00E+00	0.00E+00
Swimming	0.00E+00	0.00E+00
Boating	0.00E+00	0.00E+00
Vegetables*	0.00E+00	0.00E+00
Leafy Veg.*	0.00E+00	0.00E+00
Milk*	0.00E+00	0.00E+00
Meat*	0.00E+00	0.00E+00
Total	0.00E+00	0.00E+00

* Total population ALARA doses divided by the total population served from irrigated production; converted to mrem.

**Table 6-5 Summary of Dose from Gaseous Effluents
Year 2000**

1. Maximum Air Dose at the Site Boundary

	1st Quarter	2nd Quarter	3rd Quarter	4th Quarter	Annual Cumulative*
Beta air dose (mrad)	2.02E-04	1.17E-04	8.14E-05	2.16E-04	6.64E-04
Gamma air dose (mrad)	5.74E-04	3.32E-04	2.31E-04	6.13E-04	1.88E-03

2. Maximum Air Dose Beyond the Site Boundary

	1st Quarter	2nd Quarter	3rd Quarter	4th Quarter	Annual Cumulative*
Beta air dose (mrad)	1.33E-04	7.81E-05	8.14E-05	1.31E-04	2.95E-04
Gamma air dose (mrad)	3.76E-04	2.21E-04	2.31E-04	3.71E-04	8.37E-04

3. Maximum Annual Dose at the Site Boundary

	Annual Dose
Annual Total Body Dose (mrem)	8.22E-03
Annual Skin Dose (mrem)	8.79E-03

4. Maximum Annual Dose Beyond the Site Boundary

	Annual Dose
Annual Total Body Dose (mrem)	2.96E-03
Annual Skin Dose (mrem)	3.29E-03

* Rather than the sum of the quarters, these values are based on average annual meteorological parameters and total annual effluents.

**Table 6-5 Summary of Doses from Gaseous Effluents (Continued)
Year 2000**

5. Maximum Organ Dose at the Site Boundary

	1st Quarter	2nd Quarter	3rd Quarter	4th Quarter	Annual Cumulative*
Maximum Organ dose (mrem)	2.17E-03	1.85E-03	1.07E-02	2.92E-03	8.79E-03

6. Maximum Organ Dose Beyond the Site Boundary

	1st Quarter	2nd Quarter	3rd Quarter	4th Quarter	Annual Cumulative*
Maximum Organ dose (mrem)	1.06E-03	6.29E-04	8.56E-04	1.30E-03	3.29E-03

**7. Maximum Organ Dose at Land Use Census Location 4.1 Miles in the ESE
Sector**

	1st Quarter	2nd Quarter	3rd Quarter	4th Quarter	Annual Cumulative*
Maximum Organ dose (mrem)	1.06E-03	5.90E-04	1.39E-04	7.66E-04	2.75E-03

* Rather than the sum of the quarters, these values are based on average annual meteorological parameters and total annual effluents.

Table 6-6 50-Mile Population Dose from Gaseous Effluents

50-mile Population Collective Dose in 2000

Exposure Pathway	Total Body (person-rem)	Max. Organ (person-rem)
Plume	2.28E-03	4.06E-03
Ground	2.83E-07	3.44E-07
Inhalation	1.57E-02	1.57E-02
Vegetables	1.73E-02	1.73E-02
Milk	6.07E-03	6.06E-03
Meat	3.81E-03	3.81E-03
Total	4.52E-02	4.69E-02

Average Individual Dose in 2000*

Exposure Pathway	Total Body (mrem)	Max. Organ (mrem)
Plume	9.03E-06	1.61E-05
Ground	1.12E-09	1.36E-09
Inhalation	6.22E-05	6.22E-05
Vegetables	6.86E-05	6.86E-05
Milk	2.41E-05	2.40E-05
Meat	1.51E-05	1.51E-05
Total	1.79E-04	1.86E-04

* These values are derived by dividing the 50-mile population doses by the population within 50 miles of the Plant by direction and radii interval.

7.0 REVISIONS TO THE ODCM

This section completes the requirement of Technical Specification 5.5.1. As specified, a complete, legible copy of the entire ODCM is included as an enclosure to the letter transmitting this Radioactive Effluent Release Report to the Nuclear Regulatory Commission (NRC).

8.0 REVISIONS TO THE PROCESS CONTROL PROGRAM (PCP)

No changes were made to the Process Control Program (SWP-RMP-02) during the reporting period.

9.0 NEW OR DELETED LOCATIONS FOR DOSE ASSESSMENTS AND/OR ENVIRONMENTAL MONITORING LOCATIONS

There were no new or deleted locations for dose assessments or environmental monitoring.

10.0 MAJOR CHANGES TO RADIOACTIVE LIQUID, GASEOUS AND SOLID WASTE TREATMENT SYSTEMS

No major changes were made to the radioactive waste systems (liquid, gaseous, or solid) during this reporting period.

OFFSITE DOSE CALCULATION MANUAL

LIST OF EFFECTIVE PAGES

Page	Amendment	Page	Amendment
i	32	13	32
ii	32	14	32
iii	32	15	32
iv	32	16	32
v	32	17	32
vi	32	18	32
vii	32	19	32
viii	32	20	32
ix	32	21	32
x	32	22	32
xi	32	23	32
1	32	24	32
2	32	25	32
3	32	26	32
4	32	27	32
5	32	28	32
6	32	29	32
7	32	30	32
8	32	31	32
9	32	32	32
10	32	33	32
11	32	34	32
12	32	35	32

OFFSITE DOSE CALCULATION MANUAL

LIST OF EFFECTIVE PAGES

Page	Amendment	Page	Amendment
36	32	59	32
37	32	60	32
38	32	61	32
39	32	62	32
40	32	63	32
41	32	64	32
42	32	65	32
43	32	66	32
44	32	67	32
45	32	68	32
46	32	69	32
47	32	70	32
48	32	71	32
49	32	72	32
50	32	73	32
51	32	74	32
52	32	75	32
53	32	76	32
54	32	77	32
55	32	78	32
56	32	79	32
57	32	80	32
58	32	81	32

OFFSITE DOSE CALCULATION MANUAL

LIST OF EFFECTIVE PAGES

Page	Amendment	Page	Amendment
82	32	105	32
83	32	106	32
84	32	107	32
85	32	108	32
86	32	109	32
87	32	110	32
88	32	111	32
89	32	112	32
90	32	113	32
91	32	114	32
92	32	115	32
93	32	116	32
94	32	117	32
95	32	118	32
96	32	119	32
97	32	120	32
98	32	121	32
99	32	122	32
100	32	123	32
101	32	124	32
102	32	125	32
103	32	126	32
104	32	127	32

OFFSITE DOSE CALCULATION MANUAL

LIST OF EFFECTIVE PAGES

<u>Page</u>	<u>Amendment</u>	<u>Page</u>	<u>Amendment</u>
128	32	151	32
129	32	152	32
130	32	153	32
131	32	154	32
132	32	155	32
133	32	156	32
134	32	157	32
135	32	158	32
136	32	159	32
137	32	160	32
138	32	161	32
139	32	162	32
140	32	163	32
141	32	164	32
142	32	165	32
143	32	166	32
144	32	167	32
145	32	168	32
146	32	169	32
147	32	170	32
148	32	171	32
149	32	172	32
150	32		

ENERGY NORTHWEST

WNP-2

OFFSITE DOSE CALCULATION MANUAL

ODCM Revision as recommended

by Generic Letter 89-01

Attachment 2

OFFSITE DOSE CALCULATION MANUAL

TABLE OF CONTENTS

<u>Section</u>	<u>Title</u>	<u>Page</u>
1.0	INTRODUCTION	1
2.0	LIQUID EFFLUENT DOSE CALCULATION	1
2.1	Introduction	1
2.2	Radwaste Liquid Effluent Radiation Monitoring System	1
2.3	10 CFR 20 Release Rate Limits	2
2.3.1	Pre-Release Calculation	2
2.3.2	Post-Release Calculation	3
2.3.3	Continuous Release	4
2.4	10 CFR 50, Appendix I, Release Rate Limits	4
2.4.1	Projection of Doses	7
2.5	Radwaste Liquid Effluent Dilution Ratio and Alarm Setpoints Calculations	7
2.5.1	Introduction	7
2.5.2	Methodology for Determining the Maximum Permissible Concentration (MPC) Fraction	7
2.5.3	Methodology for the Determination of Minimum Dilution Factor	8
2.5.4	Methodology for the Determination of Liquid Effluent Monitor Setpoints ..	10
2.6	Verification of Compliance with 10 CFR 50, Appendix I, and 10 CFR 20, Appendix B	12

OFFSITE DOSE CALCULATION MANUAL

TABLE OF CONTENTS

<u>Section</u>	<u>Title</u>	<u>Page</u>
2.7	Methods for Calculating Doses to Man From Liquid Effluent Pathways	12
2.7.1	Radiation Doses	12
2.7.2	Plant Parameters	15
2.8	Compliance with Technical Specification 5.5.8.b	16
2.8.1	Maximum Allowable Liquid Radwaste Activity in Temporary Radwaste Hold-Up Tanks	16
2.8.2	Maximum Allowable Liquid Radwaste in Tanks That Are Not Surrounded by Liners, Dikes, or Walls	19
2.9	Liquid Process Monitors and Alarm Setpoints Calculations	19
2.9.1	Standby Service Water (SW) Monitor	20
2.9.2	Turbine Building Service Water (TSW) Monitor	20
2.9.3	Turbine Building Sumps Water (FD) Monitor	21
2.10	Sanitary Waste Treatment	21
3.0	GASEOUS EFFLUENTS DOSE CALCULATIONS	31
3.1	Introduction	31
3.2	Gaseous Effluent Radiation Monitoring System	33
3.2.1	Main Plant Release Point	33
3.2.2	Radwaste Building Ventilation Exhaust Monitor	33
3.2.3	Turbine Building Ventilation Exhaust Monitor	34

OFFSITE DOSE CALCULATION MANUAL

TABLE OF CONTENTS

<u>Section</u>	<u>Title</u>	<u>Page</u>
3.3	10 CFR 20 Release Rate Limits	34
	3.3.1 Noble Gases	35
	3.3.2 Radioiodines and Particulates	35
	3.3.2.1 Dose Parameter for Radionuclide i (P _i)	37
3.4	10 CFR 50 Release Rate Limits	38
	3.4.1 Noble Gases (Requirement for Operability 6.2.2.2)	38
	3.4.2 Radioiodines, Tritium and Particulates Requirement for Operability 6.2.2.3	40
	3.4.2.1 Dose Parameter for Radionuclide i (R _i)	42
	3.4.3 Annual Doses At Special Locations	47
3.5	Compliance with Requirement for Operability 6.2.2.4	48
	3.5.1 Projection of Doses	48
3.6	Calculation of Gaseous Effluent Monitor Alarm Setpoints	49
	3.6.1 Introduction	49
	3.6.2 Setpoint Determination for all Gaseous Release Paths	49
	3.6.2.1 Setpoints Calculations Based on Whole Body Dose Limits	49
	3.6.2.2 Setpoints Calculations Based on Skin Dose Limits	52

OFFSITE DOSE CALCULATION MANUAL

TABLE OF CONTENTS

<u>Section</u>	<u>Title</u>	<u>Page</u>
4.0	COMPLIANCE WITH 40 CFR 190	84
4.1	Requirement For Operability	84
4.2	ODCM Methodology for Determining Dose and Dose Commitment from Uranium Fuel Cycle Sources	84
4.2.1	Total Dose from Liquid Effluents	84
4.2.2	Total Dose from Gaseous Effluents	84
4.2.3	Direct Radiation Contribution	85
5.0	RADIOLOGICAL ENVIRONMENTAL MONITORING	85
5.1	Radiological Environmental Monitoring Program (REMP)	86
5.2	Land Use Census	87
5.3	Laboratory Intercomparison Program	87
5.4	Reporting Requirements	88
6.0	CONDUCT OF TESTS AND INSPECTIONS	103
6.0.1	Definitions	104
6.1	Instrumentation	108
6.1.1	Radioactive Liquid Effluent Monitoring Instrumentation	108
6.1.2	Radioactive Gaseous Effluent Monitoring Instrumentation	113

OFFSITE DOSE CALCULATION MANUAL

TABLE OF CONTENTS

<u>Section</u>	<u>Title</u>	<u>Page</u>
6.2	Radioactive Effluents	121
6.2.1	Liquid Effluents	121
6.2.1.1	Concentration	121
6.2.1.2	Dose	125
6.2.1.3	Liquid Radwaste Treatment System	126
6.2.2	Gaseous Effluents	126
6.2.2.1	Dose Rate	127
6.2.2.2	Dose - Noble Gases	132
6.2.2.3	Dose - Iodine-131, Iodine-133, Tritium, and Radionuclides in Particulate Form	133
6.2.2.4	Gaseous Offgas Radwaste Treatment System	134
6.2.2.5	Ventilation Exhaust Treatment System	135
6.2.2.6	Venting or Purging	136
6.2.3	Solid Radioactive Waste	137
6.2.3.1	Solid Radioactive Waste	138
6.2.4	Total Dose	140
6.3	Radiological Environmental Monitoring	143
6.3.1	Monitoring Program	143
6.3.2	Land Use Census	155

OFFSITE DOSE CALCULATION MANUAL

TABLE OF CONTENTS

<u>Section</u>	<u>Title</u>	<u>Page</u>
6.3.3	Interlaboratory Comparison Program	156
6.4	Radiological Environmental Operating/Radioactive Effluent Release Report Requirements	157
6.4.1	Annual Radiological Environmental Operating Report	158
6.4.2	Radioactive Effluent Release Report	159
6.4.3	Major Changes to Radioactive Liquid, Gaseous, and Solid Waste Treatment Systems	161
6.5	Bases For Radioactive Effluents Monitoring Requirement For Operability	162
B6.1	Instrumentation	163
	B6.1.1 Radioactive Liquid Effluent Monitoring Instrumentation	163
	B6.1.2 Radioactive Gaseous Effluent Monitoring Instrumentation	163
B6.2	Radioactive Effluents	164
	B6.2.1 Liquid Effluents	164
	B6.2.1.1 Concentration	164
	B6.2.1.2 Dose	164
	B6.2.1.3 Liquid Radwaste Treatment System	165
	B6.2.2 Gaseous Effluents	165
	B6.2.2.1 Dose Rate	165
	B6.2.2.2 Dose - Noble Gases	166

OFFSITE DOSE CALCULATION MANUAL

TABLE OF CONTENTS

<u>Section</u>	<u>Title</u>	<u>Page</u>
B6.2.2.3	Dose - Iodine- 131, Iodine- 133, Tritium, and Radionuclides in Particulate Form	167
B6.2.2.4 and 6.2.2.5	Gaseous Offgas Radwaste Treatment System and Ventilation Exhaust Treatment System	168
B6.2.2.6	Venting or Purging	168
B6.2.3.1	Solid Radioactive Waste	169
B6.2.4.1	Total Dose	170
B6.3	Radiological Environmental Monitoring	171
B6.3.1.1	Monitoring Program	171
B6.3.2.1	Land Use Census	171
B6.3.3.1	Interlaboratory Comparison Program	172

OFFSITE DOSE CALCULATION MANUAL

LIST OF TABLES

<u>Section</u>	<u>Title</u>	<u>Page</u>
<u>Section 2.0</u>		
2-1	Fish Bioaccumulation Factors (Bf) ⁽¹⁾ and Adult Ingestion Dose Conversion Factors (Df) ⁽²⁾	22
2-2	Ingestion Dose Factors (A _{it}) for Total Body and Critical Organ	25
2-3	Input Parameters Used to Calculate Maximum Individual Dose From Liquid Effluents	28
<u>Section 3.0</u>		
3-1	Dose Factors for Noble Gases and Daughters	53
3-2	Distances (Miles) to Typical Controlling Locations as Measured from Center of WNP-2 Containment Building	54
3-3	WNP-2 Long-Term Average Dispersion (X/Q) and Deposition (D/Q) Values for Typical Locations	55
3-4	Dose Rate Parameters Implementation of 10 CFR 20, Airborne Releases	56
3-5a	Dose Parameters for 10 CFR 50 Evaluations, Airborne Releases Age Group: Adult	58
3-5b	Dose Parameters for 10 CFR 50 Evaluations, Airborne Releases Age Group: Teen	59
3-5c	Dose Parameters for 10 CFR 50 Evaluations, Airborne Releases Age Group: Child	60
3-5d	Dose Parameters for 10 CFR 50 Evaluations, Airborne Releases Age Group: Infant	61
3-6	Input Parameters for Calculating R_i^c	62
3-7	Input Parameters for Calculating R_i^M	63

OFFSITE DOSE CALCULATION MANUAL

LIST OF TABLES

<u>Section</u>	<u>Title</u>	<u>Page</u>
3-8	Input Parameters for Calculating R_i^V	64
3-9	Input Parameters Needed For Calculating Dose Summaries to The Maximum Individual And The Population Within 50 Miles From WNP-2 Gaseous Effluent	65
3-10	Reactor Building Stack X/Q and D/Q Values	67
3-11	Turbine or Radwaste Building X/Q and D/Q Values	71
3-13	Characteristics of WNP-2 Gaseous Effluent Release Points	75
3-14	References for Values Listed in Tables 3-8 and 3-9	76
3-15	Design Base Percent Noble Gas (30-minute Decay)	77
3-16	Annual Doses at Typical Locations	78
3-17	Annual Occupied Air Dose at Typical Locations	79

Section 5.0

5-1	Radiological Environmental Monitoring Program Plan	90
5-2	WNP-2 REMP Locations	93
5-3	Environmental Radiological Monitoring Program Annual Summary	100
5-4	Reporting Levels for Nonroutine Operating Reports	101

OFFSITE DOSE CALCULATION MANUAL

LIST OF TABLES

<u>Section</u>	<u>Title</u>	<u>Page</u>
<u>Section 6.0</u>		
6.0-1	RFO Frequency Notation	106
6.1.1.1-1	Radioactive Liquid Effluent Monitoring Instrumentation	109
6.1.1.1.1-1	Radioactive Liquid Effluent Monitoring Instrumentation Periodic Tests and Inspections	111
6.1.2.1-1	Radioactive Gaseous Effluent Monitoring Instrumentation	114
6.1.2.1.1-1	Radioactive Gaseous Effluent Monitoring Instrumentation Periodic Tests and Inspections Requirements	117
6.4.1.1.1-1	Radioactive Liquid Waste Sampling and Analysis Program	122
6.2.2.1.2-1	Radioactive Gaseous Waste Sampling and Analysis Program	128
6.3.1.1-1	Radiological Environmental Monitoring Program	145
6.3.1.1-2	Reporting Levels for Radioactivity Concentrations in Environmental Samples . . .	151
6.3.1.1.1-1	Detection Capabilities for Environmental Sample Analysis	152

OFFSITE DOSE CALCULATION MANUAL

LIST OF FIGURES

<u>Section</u>	<u>Title</u>	<u>Page</u>
2-1	Simplified Block Diagram of Liquid Waste System	29
2-2	Simplified Block Diagram of Solid Radwaste System	30
3-1	Site Boundary for Radioactive Gaseous and Liquid Effluents	80
3-2	Simplified Block Diagram of Gaseous Waste System	81
3-3	Simplified Block Diagram of Off-Gas Treatment System	82
3-4	Auxiliary Boiler	83
5-1	Radiological Environmental Monitoring Sample Locations Inside 10-Mile Radius	98
5-2	Radiological Environmental Monitoring Sample Locations Outside 10-Mile Radius	99
5-3	Radiological Environmental Monitoring Sample Locations Near Plant 2	100

1.0 INTRODUCTION

The purpose of this manual is to provide the information and methodologies to be used by Energy Northwest to satisfy the requirements of 10 CFR 20.1302, 40 CFR Part 190, 10 CFR 50.36a, and Appendix I to 10 CFR Part 50.

2.0 LIQUID EFFLUENT DOSE CALCULATION

The U.S. Nuclear Regulatory Commission's computer program LADTAP II can be used for dose analysis for liquid radioactive effluents from WNP-2 into surface waters. The analyses estimate radiation dose to individuals, population groups, and biota from ingestion (aquatic foods, water, and terrestrial irrigated foods) and external exposure (shoreline, swimming, and boating) pathways. The calculated doses provide for determining compliance with Appendix I to 10 CFR Part 50.

2.1 Introduction

Liquid radwaste released from WNP-2 will meet 10 CFR 20 limits at the point of discharge to the Columbia River. Actual discharges of liquid radwaste effluents will only occur on a Batch Basis, and the average concentration at the point of discharge will be only a small percentage of the allowed limits. A simplified block diagram of the liquid waste management system and effluent pathways is contained in Figure 2-1. Solid radioactive wastes are disposed of by way of an approved disposal site. A simplified block diagram of the solid radwaste system is described in Figure 2-2.

The cumulative quarterly dose contributions due to radioactive liquid effluents released to the unrestricted areas will be determined once every 31 days using the LADTAP II computer code.

The dose contributions will be calculated for all radionuclides identified in the released effluent based on guidelines provided by NUREG-0133.

The methods for calculating the doses are discussed in Section 2.4 of this manual.

2.2 Radwaste Liquid Effluent Radiation Monitoring System

This monitoring subsystem measures the radioactivity in the liquid effluent prior to its entering the cooling tower blowdown line.

All radwaste effluent passes through a four-inch line which has an off-line sodium iodide radiation monitor. The radwaste effluent flow, variable from 0 to 190 gpm, combines with the 36-inch cooling water blowdown line, variable from 0 to 7500 gpm and is discharged to the Columbia River with a total flow based on MPC_i total, and cooling water flushing needs.

The radiation monitor is located on the 437' level of the Radwaste Building and has a minimum sensitivity of 10^{-6} $\mu\text{Ci/cc}$ for Cs-137. The radiation indicator has seven decades of range.

2.3 10 CFR 20 Release Rate Limits

The requirements pertaining to discharge of radwaste liquid effluents to the unrestricted area are specified in Requirement for Operability 6.2.1.1.

In order to comply with this requirement, limits will be set to assure that blowdown line concentrations do not exceed 10 CFR 20, Appendix B, Table II, Column 2 at any time.

2.3.1 Pre-Release Calculation

The activity of the radionuclide mixture and the liquid effluent discharge rate will be determined in accordance with Energy Northwest procedures. The effluent concentration is determined by the following equation:

$$\text{Conc}_i = \frac{C_i \times fw}{ft} \quad (1)$$

where:

- Conc_i = Concentration of radionuclide i in the effluent at point of discharge - $\mu\text{Ci/ml}$.
- C_i = Concentration of radionuclide i in the batch to be released - $\mu\text{Ci/ml}$.
- fw = Discharge flow rate from sample tank to the blowdown line - variable from 0 to 190 gpm.
- fb = Blowdown flow rate - variable from 0 to 7500 gpm.
- ft = Total discharge (ft = fb + fw) flow rate - variable from 0 to 7690 gpm.

The calculated concentration in the blowdown line must be less than the concentrations listed in 10 CFR 20, Appendix B. Before releasing the batch to the environment, the following equation must hold:

$$\sum_{i=1}^m (\text{Conc}_i / \text{MPC}_i) \leq 1 \quad (2)$$

where:

- Conc_i = The concentration of radionuclide i in the effluent at the point of discharge into the river.
- MPC_i = Maximum permissible concentration of nuclide i as listed in 10 CFR 20, Appendix B, Table II.
- m = Total number of radionuclides in the batch.

2.3.2 Post-Release Calculation

The concentration of each radionuclide in the unrestricted area, following the batch release, will be calculated as follows:

The average activity of radionuclide i during the time period of the release is divided by the Plant Discharge Flow/Tank Discharge Flow ratio yielding the concentration at the point of discharge:

$$\text{Conc}_{ik} = \frac{C_{ik} \times fw}{ft} \quad (3)$$

where:

- Conc_{ik} = The concentration of radionuclide i in the effluent at the point of discharge during the release period k - (μCi/ml).
- C_{ik} = The concentration of radionuclide i in the batch during the release period k - (μCi/ml).
- fw = Discharge flow rate from sample tank to the blowdown line - variable from 0 to 190 gpm.

The dose contribution will be calculated for all radionuclides identified in the liquid effluent released to the unrestricted area, using the following equation:

$$D\tau = \sum_i (A_{i\tau} \sum_{\ell=1}^m \Delta t_{\ell} C_{i\ell} F_{\ell}) \quad (5)$$

where:

- $D\tau$ = The cumulative dose commitment to the total body or organ, τ , from liquid effluents for the total time period $\sum_{\ell=1}^m \Delta t_{\ell}$, in mrem.
- Δt_{ℓ} = The length of the ℓ th time period over which $C_{i\ell}$ and F_{ℓ} are averaged for all liquid releases, in hours.
- m = The number of releases for the time period under consideration.
- $C_{i\ell}$ = The average concentration of radionuclide i in undiluted liquid effluent during time period Δt_{ℓ} from any liquid release, in $\mu\text{Ci/ml}$.
- $A_{i\tau}$ = The site-related ingestion dose commitment factor to the total body or any organ τ for each identified principle gamma and beta emitter listed in Table 2-2, in mrem/hr per $\mu\text{Ci/ml}$.
- F_{ℓ} = The near field average dilution factor for $C_{i\ell}$ during any liquid waste release. This is defined as the ratio of the maximum undiluted liquid waste flow during release to the product of the average flow from the site discharge structure to unrestricted receiving waters times 500.

While the actual discharge structure exit flow is variable from 0 to 17.1 cfs (0 to 7690 gpm), a maximum flow value of 2.0 cfs will be used for dose calculation purposes in accordance with the NUREG-0133 requirement that the product of the average blowdown flow to the receiving water body, in cfs and the applicable factor (500), is 1000 cfs or less.

$$(F_{\ell} = \frac{\text{Liquid Radioactive Waste Flow}}{\text{Discharge Structure Exit Flow} \times 500} = \frac{fw}{ft \times 500}) \quad (6)$$

The term A_{it} , the ingestion dose factors for the total body and critical organs, are tabulated in Table 2-2. It embodies the dose factor, fish bioaccumulation factor, pathway usage factor, and the dilution factor for the plant diffuser pipe to the Richland potable water intake. The following equation was used to calculate the ingestion dose factors:

$$A_{it} = K_o (U_w/D_w + U_F BF_i) DF_i \quad (7)$$

where:

- A_{it} = The composite dose parameter for total body or critical organ of an adult for nuclide i (in mrem/hr per $\mu\text{Ci/ml}$).
- K_o = A conversion factor:
 $1.14\text{E}+05 = (10^6 \text{ pCi}/\mu\text{Ci}) \times (10^3 \text{ ml/liter})/8760 \text{ hr/yr.}$
- U_w = 730 liter/yr - which is the annual water consumption by the maximum adult (Table E-4 of Regulatory Guide 1.109, Revision 1).
- BF_i = Bioaccumulation factor for radionuclide i in fish - (pCi/Kg per pCi/liter) (Table A-1 of Regulatory Guide 1.109, Revision 1 and NUREG/CR-4013).
- DF_i = Adult ingestion dose conversion factor for nuclide i - Total body or critical organ, τ , in (mrem/pCi) (Table E-11 of Regulatory Guide 1.109, Revision 1 and NUREG/CR-4013).
- D_w = Dilution factor from near field area (within one-quarter mile of the release point) to the Richland potable water intake - 100.
- U_F = Adult fish consumption, 21 kg/yr (Table E-5 of Regulatory Guide 1.109, Revision 1).

The values of BF_i and DF_i are listed in Table 2-1. Dilution assumptions, calculations, and LADTAP II input parameters are provided in Radiological Health Calculation Log 92-2.

The quarterly limits mentioned before represent one-half of the annual design objective of Section II.A of 10 CFR 50, Appendix I. If any of the limits (either that of the calendar quarter or calendar year) are exceeded, a special report pursuant to Section IV.A of 10 CFR 50, Appendix I, shall be filed with the NRC.

2.4.1 Projection of Doses

The projected doses due to releases of WNP-2 radwaste liquid effluents will be calculated for each batch, using Equation (5) or LADTAP II. If the sum of the accumulated dose to date for the month and the projected dose for the remainder of the month exceeds the Requirement for Operability 6.2.1.3 limits, then the liquid radwaste treatment system shall be used. This is to ensure compliance with Requirement for Operability 6.2.1.3. This Requirement for Operability states that the liquid radwaste treatment system shall be maintained and the appropriate subsystem shall be used if the radioactive materials in liquid waste, prior to their discharge, when the dose, due to liquid effluent release to unrestricted areas when averaged over the month would exceed 0.06 mrem to total body or 0.2 mrem to any organ.

2.5 Radwaste Liquid Effluent Dilution Ratio and Alarm Setpoints Calculations

2.5.1 Introduction

The dilution alarm ratio and setpoints of the sample liquid effluent monitor are established to ensure that the limits of 10 CFR 20, Appendix B, Table II, Column 2, are not exceeded in the effluent at the discharge point (i.e., compliance with Requirement for Operability 6.2.1.1, as discussed in section 2.3.1 of this manual).

The alarm (HI) and the alarm/trip (HI-HI) setpoints for the liquid radwaste effluent monitor are calculated from the results of the radiochemical analysis of the effluent sample. The setpoints will be set into the radwaste monitor just prior to the release of each batch of radioactive liquid.

2.5.2 Methodology for Determining the Maximum Permissible Concentration (MPC) Fraction

Radwaste liquid effluents can only be discharged to the environment through the four-inch radwaste line. The maximum radwaste discharge flow rate is 190 gpm. Prior to discharge, the tank is isolated and recirculated for at least thirty minutes, and a representative sample is taken from the tank. An isotopic analysis of the batch will be made to determine the sum of the MPC fraction (MPC_f) based on 10 CFR 20 limits. From the sample analysis and the MPC values in 10 CFR 20, the MPC_f is determined using the following equation.

$$MPC_f = \sum_{i=1}^m \frac{c_i}{MPC_i} \quad (8)$$

where:

- MPC_f = Total fraction of the Maximum Permissible Concentrations (MPCs) in the liquid effluent waste sample.
- C_i = The concentration of each measured radionuclide i observed by the radiochemical analysis of the liquid waste sample ($\mu\text{Ci/ml}$).
- MPC_i = The limiting concentrations of the appropriate radionuclide i from 10 CFR 20, Appendix B, Table II, Column 2. For dissolved or entrained noble gases, the concentration shall be limited to $2.0\text{E-}04 \mu\text{Ci/ml}$ total activity.
- m = The total number of measured radionuclides in the liquid batch to be released.

If the MPC_f is less than or equal to 0.8, the liquid batch may be released at any radwaste discharge or blowdown rate. If the MPC_f exceeds 0.8, then a dilution factor (F_d) must be determined. The liquid effluent radiation monitor responds proportionally to radioactivity concentrations in the undiluted waste stream. Its setpoint must be determined for diluted releases.

2.5.3 Methodology for the Determination of Minimum Dilution Factor

The measured radionuclide concentrations are used to calculate the dilution factor (F_d), which is the ratio of the total discharge flow rates ($RW + CBD$) to the radwaste tank effluent flow rate (RW) that is required to assure that the limiting concentrations of Requirement for Operability 6.2.1.1 are met at the point of discharge.

The minimum dilution factor (F_d) is determined according to:

$$F_d = \left[\sum_{i=1}^m \frac{C_i}{MPC_i} \right] \times F_s \quad (9)$$

where:

- F_d = The minimum dilution factor required for compliance with 10 CFR 20, Appendix B, Table II, Column 2.
- C_i = The concentration of each radionuclide i observed by radiochemical analysis of the liquid waste sample ($\mu\text{Ci/ml}$).

- MPC_i = The limiting concentration of the appropriate radionuclide i from 10 CFR 20, Appendix B, Table II, Column 2. For dissolved or entrained noble gases, the concentration shall be limited to $2.0E-04 \mu\text{Ci/ml}$ total activity.
- F_s = The safety factor; a conservative factor used to compensate for statistical fluctuations and errors in measurements. For example, a safety factor (F_s) of 1.5 corresponds to a fifty (50) percent (%) variation. The safety factor is 1.5.
- m = The total number of measured radionuclides i in the liquid batch to be released.

The dilution which is required to ensure compliance with Requirement for Operability 6.2.1.1 concentration limits will be set such that discharge rates are:

$$F_d \leq \frac{RW + CBD}{RW} \quad (10)$$

and follows that:

$$RW \leq \frac{CBD}{F_d - 1} \quad (10a)$$

or

$$CBD \geq RW(F_d - 1) \quad (10b)$$

where:

- F_d = The minimum dilution factor from Equation (9).
- RW = The discharge flow rate from the liquid radwaste tank to the blowdown line - variable from 0 to 190 gpm.
- CBD = The cooling tower blowdown flow rate - variable from 0 to 7500 gpm.

2.5.4 Methodology for the Determination of Liquid Effluent Monitor Setpoints

Liquid effluents must meet the restrictions at the point of discharge to the river of 1 MPC or less after dilution. Therefore, the Liquid Effluent Monitor setpoint must be determined such that it will terminate a discharge at less than or equal to that point. The dilution factor must satisfy Equation (10).

$$\text{Setpoint} \leq C_M \left(\frac{\text{CBD} + \text{RW}}{\text{RW}} \right) \quad (11)$$

where:

Setpoint = the radwaste effluent monitor setpoint in $\mu\text{Ci/ml}$. C_M is the maximum permissible diluted concentration, in $\mu\text{Ci/ml}$, at the point of release that is in compliance with 10CFR20 Appendix B Table II column 2.

The Liquid Effluent Monitor measures the undiluted effluent, therefore the term

$$\frac{\text{CBD} + \text{RW}}{\text{RW}}$$

is used to correct for dilution.

CBD = the rate of dilution blowdown to the river in gpm.

RW = the rate of discharge from radwaste to the dilution blowdown line in gpm

The MPC fraction of the batch to be discharged, MPC_f is defined in Equation (8).

Since the final concentration must be less than or equal to one MPC:

$$C_M = \left(\frac{1}{\text{MPC}_f} \right) \sum_{i=1}^m C_i \quad (11a)$$

Substituting into Equation (11):

$$\text{Setpoint} \leq \left(\frac{1}{\text{MPC}_f} \right) \left(\sum_{i=1}^m C_i \right) \left(\frac{\text{CBD} + \text{RW}}{\text{RW}} \right) \quad (11b)$$

The Liquid Effluent Monitor reads out in counts per second (cps), therefore, it is necessary to convert the setpoint from $\mu\text{Ci/ml}$ to cps.

$$S_{\text{HHI}} \leq \left(\frac{1}{\text{MPC}_f} \right) \left(\sum_{i=1}^m (C_i) (E_i) \right) \left(\frac{\text{CBD} + \text{RW}}{\text{RW}} \right) + \text{BKG} \quad (11c)$$

where:

- S_{HHI} = the trip setpoint in cps
- E_i = the monitor efficiency for nuclide i , in cps/ $\mu\text{Ci/ml}$
- BKG = the monitor background in cps.

At low activity levels, the monitor demonstrates a normal instrument variation. In order to prevent spurious alarms and trips resulting from this variation, the setpoint can be calculated using a 1.0 MPC_f representative mixture when the MPC_f of the batch is less than 1.0 MPC_f .

The effluent monitor also has a high alarm setpoint that will be set to alarm if the batch contents exceed the concentration expected for the current discharge. This will warn the operator that the batch release is not proceeding as anticipated by the prerelease calculation, discharge should be stopped and the alarm cause investigated. The Hi alarm setpoint is determined to be at the monitor response for the current batch release multiplied by 1.25 to allow for normal variation in the monitor response. When the MPC_f of the batch is less than 1.0 MPC_f , the high setpoint will be the greater of either the calculated setpoint, or 80% of the setpoint determined from a 1.0 MPC_f mixture.

$$S_{\text{HI}} \leq \text{BKG} + 1.25 \sum_{i=1}^m (C_i) (E_i) \quad (12)$$

where:

S_{HI} is the monitor Hi setpoint in cps.

1.25 is a factor to account for normal variation in the monitor reading. It results in a maximum of a 25% greater than expected count rate before the alarm occurs.

$$S_{\text{HI}} \leq \text{BKG} + (0.8 * \text{One-MPC}) \quad (12a)$$

Where one-MPC is the count rate corresponding to a 1.0 MPC_f representative mixture.

All other terms defined in Equation 12.

2.6 Verification of Compliance with 10 CFR 50, Appendix I, and 10 CFR 20, Appendix B

Verification of compliance with 10 CFR 50, Appendix I, and 10 CFR 20, Appendix B, limits will be achieved by following WNP-2 Plant Procedures for liquid discharge and the periodic application of the LADTAP II computer code.

2.7 Methods for Calculating Doses to Man From Liquid Effluent Pathways

Dose models presented in NRC Regulatory Guide 1.109, Revision 1, as incorporated in the LADTAP II computer code, will be used for offsite dose calculation. The details of the computer code, and user instruction, are included in NUREG/CR-4013, "LADTAP II - Technical Reference and User Guide."

2.7.1 Radiation Doses

Radiation doses from potable water, aquatic food, shoreline deposit, and irrigated food pathways will be calculated by using the following equations:

a. Potable Water

$$R_{apj} = 1100 \frac{U_{ap} M_p}{F} \sum_i Q_i D_{aipj} \exp(-\lambda_i t_p) \quad (13)$$

b. Aquatic Foods

$$R_{apj} = 1100 \frac{U_{ap} M_p}{F} \sum_i Q_i B_{ip} D_{aipj} \exp(-\lambda_i t_p) \quad (14)$$

c. Shoreline Deposits

$$R_{apj} = 110,000 \frac{U_{ap} M_p W}{F} \sum_i Q_i T_i D_{aipj} [\exp(-\lambda_i t_p) (1 - \exp(-\lambda_i t_b))] \quad (15)$$

d. Irrigated foods

For all radionuclides except tritium:

$$\begin{aligned}
 R_{apj} = & U_{ap}^{veg} \sum_i d_i \exp(-\lambda_i t_h) D_{aipj} \left[\frac{r [1 - \exp(-\lambda_{Ei} t_e)]}{Y_v \lambda_{Ei}} + \frac{f_i B_{iv} [1 - \exp(-\lambda_i t_b)]}{P \lambda_i} \right] \\
 & + U_{ap}^{animal} \sum_i F_{iA} D_{aipj} \left[Q_F d_i \exp(-\lambda_i t_h) \frac{r [1 - \exp(-\lambda_{Ei} t_e)]}{Y_v \lambda_{Ei}} \right. \\
 & \left. + \frac{f_i B_{iv} [1 - \exp(-\lambda_i t_b)]}{P \lambda_i} + C_{iAw} Q_{Aw} \right] \quad (16)
 \end{aligned}$$

For tritium:

$$R_{apj} = U_{ap}^{veg} C_v D_{apj} + U_{ap}^{animal} D_{apj} F_A (C_v Q_F + C_{Aw} Q_{Aw}) \quad (17)$$

where:

- B_{ip} = The equilibrium bioaccumulation factor for nuclide i in pathway p , expressed as the ratio of the concentration in biota (in pCi/kg) to the radionuclide concentration in water (in pCi/liter), in liters/kg.
- B_{iv} = The concentration factor for uptake of radionuclide i from soil by edible parts of crops, in pCi/kg (wet weight) per pCi/kg dry soil.
- C_{iAw} = The concentration of radionuclide i in water consumed by animals, in pCi/liter.
- C_{iv} = The concentration of radionuclide i in vegetation, in pCi/kg.
- D_{aipj} = The dose factor specific to a given age group a , radionuclide i , pathway p , and organ j , which can be used to calculate the radiation dose from an intake of a radionuclide, in mrem/pCi, or from exposure to a given concentration of a radionuclide in sediment, expressed as a ratio of the dose rate (in mrem/hr) and the area radionuclide concentration (in pCi/m²).
- d_i = The deposition rate of nuclide i in pCi/m² per hour.
- F = The flow rate of the liquid effluent, variable from 0 to 2.0 cfs, for dose calculation purposes.

- f_i = The fraction of the year crops are irrigated, dimensionless.
- F_{iA} = The stable element transfer coefficient that relates the daily intake rate by an animal to the concentration in an edible portion of animal product, in pCi/liter (milk) per pCi/day or pCi/kg (animal product) per pCi/day.
- M_p = The mixing ratio (reciprocal of the dilution factor) at the point of exposure (or the point of withdrawal of drinking water or point of harvest of aquatic food), dimensionless.
- P = The effective "surface density" for soil, in kg (dry soil)/m² (Table E-15, Regulatory Guide 1.109, Revision 1).
- Q_{Aw} = The consumption rate of contaminated water by an animal, in liters/day.
- Q_F = The consumption rate of contaminated feed or forage by an animal, in kg/day (wet weight).
- Q_i = The release rate of nuclide i in Ci/yr.
- r = The fraction of deposited activity retained on crops, dimensionless (Table E-15, Regulatory Guide 1.109, Revision 1).
- R_{api} = The total annual dose to organ j of individuals of age group a from all of the nuclides i in pathway p , in mrem/yr.
- t_b = The period of time for which sediment or soil is exposed to the contaminated water, in hours (Table E-15, Regulatory Guide 1.109, Revision 1).
- t_c = The time period that crops are exposed to contamination during the growing season, in hours (Table E-15, Regulatory Guide 1.109, Revision 1).
- t_h = A holdup time that represents the time interval between harvest and consumption of the food, in hours (Table E-15, Regulatory Guide 1.109, Revision 1).
- T_i = The radioactive half life of nuclide i in days.
- t_p = The average transit time required for nuclides to reach the point of exposure. For internal dose, t_p is the total time elapsed between release of the nuclides and ingestion of food or water, in hours (Table E-15, Regulatory Guide 1.109, Revision 1).

- U_{ap} = A usage factor that specifies the exposure time or intake rate for an individual of age group a associated with pathway p, in hr/yr, L/yr, or kg/yr (Table E-5, Regulatory Guide 1.109, Revision 1).
- W = The shoreline width factor, dimensionless (Table A-2, Regulatory Guide 1.109, Revision 1).
- Y_v = The agricultural productivity (yield), in kg (wet weight)/m² (Table E-15, Regulatory Guide 1.109, Revision 1).
- λ_{Ei} = The effective removal rate constant for radionuclide i from crops, in hr⁻¹, where $\lambda_{Ei} = \lambda_i + \lambda_w$, λ_i is the radioactive decay constant, and λ_w is the removal rate constant for physical loss by weathering (Regulatory Guide 1.109, Revision 1, Table B-15).
- λ_i = The radioactive decay constant of nuclide i in hr⁻¹.
- 1100 = The factor to convert from (Ci/yr)/(ft³/sec) to pCi/liter.
- 110,000 = The factor to convert from (Ci/yr)/(ft³/sec) to pCi/liter and to account for the proportionality constant used in the sediment radioactivity model.

These equations yield the dose rates to various organs of individuals from the exposure pathways mentioned above.

2.7.2 Plant Parameters

WNP-2 is a river shoreline site with a variable effluent discharge flow rate 0 to 7690 gpm. The population center nearest WNP-2 is the city of Richland, where drinking water withdrawal takes place. The applicable dilution factor is 50,000, using average river flow. The time required for released liquids to reach Richland, approximately 12 miles downstream, is estimated at 4.0 hours. Richland is the "realistic case" location, and doses calculated for the Richland location are typically applicable to the population as a whole. Individual and population doses based on Richland parameters are calculated for all exposure pathways.

Only the population downstream of the WNP-2 site is affected by the liquid effluents released. There is no significant commercial fish harvest in the 50-mile radius region around WNP-2. Sportfish harvest is estimated at 14,000 kg/year.

For irrigated foods exposure pathways, it can be assumed that production within the 50-mile radius region around WNP-2 is sufficient to satisfy consumption requirements.

Other relevant parameters relating to the irrigated foods pathways are defined as follows:

<u>Food Type</u>	<u>Irrigation Rate</u> (liter/m ² /mo)	<u>Annual Yield</u> (kg/m ²)	<u>Growing Period</u> (Days)
Vegetation	150	5.0	70
Leafy Vegetation	200	1.5	70
Feed for Milk Cows	200	1.3	30
Feed for Beef Cattle	160	2.0	130

Source terms are measured based on sampled effluent.

Table 2-3 summarizes the LADTAP II input parameters. Documentation and/or calculations of these parameters are discussed in detail in PPM 16.12.1, and Radiological Health Calculation Log 92-2.

2.8 Compliance with Technical Specification 5.5.8.b

2.8.1 Maximum Allowable Liquid Radwaste Activity in Temporary Radwaste Hold-Up Tanks

The use of temporary liquid radwaste hold-up tanks is planned for WNP-2. Technical Specification 5.5.8.b states the quantity of radioactive material contained in any outside temporary tanks shall be limited to the limits calculated in the ODCM such that a complete release of the tank contents would not result in a concentration at the nearest offsite potable water supply that would exceed the limits specified in 10 CFR Part 20 Appendix B, Table II.

Equation (18) will be used to calculate the curie limit for a temporary radwaste hold-up tank. The total tank concentration will be limited to less than or equal to ten (≤ 10) curies, excluding tritium and dissolved or entrained gases.

The quantity of radioactive material in the hold-up tanks shall be determined to be within the limit by analyzing a representative sample of the tank's contents at least once per 7 days when radioactive materials are being added to the tank.

$$A_T = \frac{k_d}{\sum_i \frac{f_i}{MPC_i e^{\lambda_i t}}} \quad (18)$$

where:

- A_T = Total allowed activity in tank (curies).
- A_i = Activity of radioisotope i (curies).
- MPC_i = Maximum permissible concentration of radionuclide i (10 CFR 20, Appendix B, Table II, Column 2).
- λ_i = Decay constant (years^{-1}) radioisotope i .
- t = Transit time of ground water from WNP-2 to WNP-1 well (WNP-2 FSAR Section 2.4) = 67 years.
- f_i = Fraction of radioisotope $f_i = \frac{A_i}{\sum A_i}$
- i = Index for all radioisotopes in tank except tritium and noble gases.
- K_d = Dispersion constant based on hydrological parameters, ($2.4E+05$ Ci per $\mu\text{Ci/cc.}$)

The total allowed activity (A_T) is based on limiting WNP-1 well water to less than 1 MPC_i of the entire liquid content of the tank spilled to ground and then migrated via ground water to the WNP-1 well. The WNP-1 well is the location of maximum concentration since it is the nearest source of ground water and conditions are such that no spill of liquid should reach surface water. The 70-85 foot depth of the water table and the low ambient moisture of the soil requires a rather large volume of spillage for the liquid to even reach the water table in less than several hundred years. However, allowed tank activity (A_T) is conservatively based on all liquid radwaste in the tank instantaneously reaching the water table.

The hydrological analysis performed for the WNP-2 FSAR (Section 2.4) determined that the transit time through the ground water from WNP-2 to the WNP-1 well is 67 years for Strontium and 660 years for Cesium. These two radionuclides are representative of the radionuclides found in liquid radwaste. Strontium is a moderate sorber and Cesium strongly sorbs to soil particles. This calculation conservatively treats all radionuclides as moderate sorbers with a transit time of 67 years.

The concentration of each radionuclide in the well (CW_i) is simply the concentration in the tank (CT_i) adjusted for radioactive decay during transit ($e^{-\lambda t}$) and divided by the minimum concentration reduction factor (CRF_{\min}). Limiting well concentration to 1 MPC yields:

$$\sum \frac{CW_i}{MPC_i} = 1 = \sum \frac{CT_i e^{-\lambda t}}{CRF_{\min} MPC_i} \quad (19)$$

(From Section 2.4 of WNP-2 FSAR)

$$CRF_{\min} = \frac{(4 \pi L)^{3/2} (\alpha_x \alpha_y \alpha_z)^{1/2}}{2V} \quad (20)$$

where:

L = Migration distance = 1 mile.

V = Volume of tank.

$\alpha_x, \alpha_y, \alpha_z$ = Dispersion constants.

Combining Equations (19) and (20) yields:

$$1 = \sum \frac{CT_i 2V e^{-\lambda t}}{(4 \pi L)^{3/2} (\alpha_x \alpha_y \alpha_z)^{1/2} MPC_i} \quad (21)$$

Substituting A_i for $CT_i V$ and reorganizing terms yields:

$$\frac{(4 \pi L)^{3/2} (\alpha_x \alpha_y \alpha_z)^{1/2}}{2} = \sum \frac{A_i}{MPC_i e^{+\lambda t}} \quad (22)$$

Making the following substitutions

$$A_i = f_i A_T$$

$$K_d = \frac{(4 \pi L)^{3/2} (\alpha_x \alpha_y \alpha_z)^{1/2}}{2} \times 10^{-6} \text{ Ci}/\mu\text{Ci} = 2.4 \times 10^5 \text{ Ci per } \mu\frac{\text{Ci}}{\text{cc}} \quad (23)$$

yields:

$$K_d = A_T \sum \frac{f_i}{\text{MPC}_i e^{-\lambda t}}$$

or

$$A_T = \frac{K_d}{\sum \frac{f_i}{\text{MPC}_i e^{-\lambda t}}}$$

2.8.2 Maximum Allowable Liquid Radwaste in Tanks That Are Not Surrounded by Liners, Dikes, or Walls

Although permanent outside liquid radwaste tanks which are not surrounded by liners, dikes, or walls are not planned for WNP-2, Equation (18) will be used should such tanks become necessary in the future.

2.9 Liquid Process Monitors and Alarm Setpoints Calculations

As mentioned in Section 2.2 of this manual, all liquid radwaste effluent is discharged through a four-inch line that is monitored by an off-line sodium iodide radiation monitor. This monitor is located on the 437' level of the Radwaste Building. All WNP-2 radwaste liquid effluent is discharged to the Columbia River through the 36-inch Cooling Water Blowdown line. In addition to the liquid effluent discharge monitor there are three liquid streams that are normally nonradioactive but have a finite possibility of having radioactive material injected into them. These liquid streams are:

- Standby Service Water (SW)
- Turbine Building Service Water (TSW)
- Turbine Building Sump Water (FD)

To prevent any discharges of radioactive liquid from these streams, radiation monitoring systems have been installed to detect any increase above the normal background concentration of radioactive material.

Alarm/setpoints are established to prevent any release of radioactive material inconcentrations greater than 10 CFR 20 limits. The maximum radiation detector setpoint calculation for the three systems is based on the MPC_i concentration of Cs-137 which is 2.0E-05 $\mu\text{Ci/ml}$. The following equation is used to calculate the maximum setpoint:

$$\text{Setpoint max. (in cpm or cps)} = [(2.0\text{E-}05 \mu\text{Ci/ml}) (\text{CF})] \quad (25)$$

where:

2.0E-05 $\mu\text{Ci/ml}$ = MPC limit for Cs-137

CF = Monitor calibration factor - in cpm/ $\mu\text{Ci/ml}$ or cps/ $\mu\text{Ci/ml}$

2.9.1 Standby Service Water (SW) Monitor

The Standby Service Water Monitors (SW) are located on the 522' level of the Reactor Building.

The meter is located in the main control room on panel P-604.

The flow rate through the monitor is variable, from zero (0) to two (2) gpm with a normal flow of 1.0-1.5 gpm.

To ensure 10 CFR 20 limits are never exceeded, the alarm setpoint shall be established at 80% or less of the maximum setpoint plus background.

If the setpoint is exceeded, an alarm will activate in the main control room. The control room operator can then terminate the discharge and mitigate any uncontrolled release of radioactive material.

2.9.2 Turbine Building Service Water (TSW) Monitor

This monitor is located on the 441' level of the Turbine Building. The readout meter and recorder is located in the main control panel BD-RAD-24.

The flow rate through that monitor is variable, from zero (0) to five (5) gpm with a normal flow of 1-2 gpm.

To ensure 10 CFR 20 limits are never exceeded, the alarm setpoint shall be established at 80% or less of the maximum setpoint plus background.

If the setpoint is exceeded, an alarm will activate in the main control room. The control room operator can then terminate the discharge and mitigate any uncontrolled release of radioactive material.

2.9.3 Turbine Building Sumps Water (FD) Monitor

There are three detectors to measure the activity of each of the three nonradioactive sumps. The monitors are located on the 441' level of the Turbine Building. The readout meters and recorder are located in the Radwaste Control Room Panel BD-RAD-41. The alarm/setpoint for these detectors is established by design at 80% of the 10 CFR Part 20, Appendix B, Table II value for Cs-137. In the event the setpoint is exceeded, the sump discharge will be automatically diverted to the Radwaste system for processing.

Turbine building sumps, T1, T2, and T3 are normally routed to the liquid radwaste system. Effluent from these turbine building sumps may be routed to the storm water system if analyses indicate no detectable radioactivity is present. Other inputs to the storm waste system, in addition to rain water, include water treatment filter backwashes, Service Building and Emergency Diesel Generator Building floor drains, HVAC air wash units, and condensed steam from plant steam leaks that collect on rooftops during cool weather. The storm water system terminates in an unlined depression or pond located 1500 feet northeast of the plant. Releases to the storm drain pond are sampled as part of the Radiological Environmental Monitoring Program. Based on past experience, it is expected that there will be some accumulation of low levels of radioactive materials, particularly tritium, in the pond.

2.10 Sanitary Waste Treatment

Sanitary wastes from WNP-2, WNP-1/4, the Plant Support Facility, and the Department of Energy's 400 Area facilities are directed to Energy Northwest's central sanitary waste treatment facility. The facility utilizes a standard treatment process involving lined aerated lagoons and facultative stabilization ponds. The treated effluent is discharged to ground via percolation beds.

The operation of the sanitary waste treatment facility is regulated by the State of Washington. Routine monitoring of the treatment facility is performed by the Radiological Environmental Monitoring Program. Low levels of radioactive materials, particularly tritium from the 400 Area, are expected to be present in the treatment facility as a result of processing these waste streams.

Table 2-1

**FISH BIOACCUMULATION FACTORS (BF)⁽¹⁾
AND ADULT INGESTION DOSE CONVERSION FACTORS (DF)_i⁽²⁾**

<u>Nuclide</u>	<u>Fish Bioaccumulation Factor (BF)_i (pCi/kg per pCi/liter)</u>	<u>Dose Conversion Factor (DF)_i</u>				
		<u>Total Body</u>	<u>Bone</u>	<u>Thyroid</u>	<u>Liver</u>	<u>GI Tract</u>
H-3	9.0E-01	6.0E-08	___(3)	6.0E-08	6.0E-08	6.0E-08
Na-24	1.0E+02	1.7E-06	1.7E-06	1.7E-06	1.7E-06	1.7E-06
P-32	1.0E+05	7.5E-06	1.9E-04	___(3)	1.2E-05	2.2E-05
Cr-51	2.0E+02	2.7E-09	___(3)	1.6E-09	___(3)	6.7E-07
Mn-54	4.0E+02	8.7E-07	___(3)	___(3)	4.6E-06	1.4E-05
Mn-56	4.0E+02	2.0E-08	___(3)	___(3)	1.2E-07	3.7E-06
Fe-55	1.0E+02	4.4E-07	2.8E-06	___(3)	1.9E-06	1.1E-06
Fe-59	1.0E+02	3.9E-06	4.3E-06	___(3)	1.0E-05	3.4E-05
Co-58	5.0E+01	1.7E-06	___(3)	___(3)	7.5E-07	1.5E-05
Co-60	5.0E+01	4.7E-06	___(3)	___(3)	2.1E-06	4.0E-05
Ni-65	1.0E+02	3.1E-08	5.3E-07	___(3)	6.9E-08	1.7E-06
Cu-64	5.0E+01	3.9E-08	___(3)	___(3)	8.3E-08	7.1E-06
Zn-65	2.0E+03	7.0E-06	4.8E-06	___(3)	1.5E-05	9.7E-06
Zn-69m	2.0E+03	3.7E-08	1.7E-07	___(3)	4.1E-07	2.5E-05
As-76	1.0E+02	4.8E-06	___(3)	___(3)	___(3)	4.4E-05
Br-82	4.2E+02	2.3E-06	___(3)	___(3)	___(3)	2.6E-06
Br-83	4.2E+02	4.0E-08	___(3)	___(3)	___(3)	5.8E-08
Br-84	4.2E+02	5.2E-08	___(3)	___(3)	___(3)	4.1E-13
Rb-89	2.0E+03	2.8E-08	___(3)	___(3)	4.0E-08	2.3E-21
Sr-89	3.0E+01	8.8E-06	3.1E-04	___(3)	___(3)	4.9E-05
Sr-90	3.0E+01	1.8E-04	8.7E-03	___(3)	___(3)	2.2E-04
Sr-91	3.0E+01	2.3E-07	5.7E-06	___(3)	___(3)	2.7E-05
Sr-92	3.0E+01	9.3E-08	2.2E-06	___(3)	___(3)	4.3E-05
Y-90	2.5E+01	2.6E-10	9.7E-09	___(3)	___(3)	1.0E-04
Y-91m	2.5E+01	3.5E-12	9.1E-11	___(3)	___(3)	2.7E-10
Y-91	2.5E+01	3.8E-09	1.4E-07	___(3)	___(3)	7.8E-05

Table 2-1

FISH BIOACCUMULATION FACTORS (BF)⁽¹⁾
AND ADULT INGESTION DOSE CONVERSION FACTORS (DF)⁽²⁾

Nuclide	Fish Bioaccumulation Factor (BF) (pCi/kg per pCi/liter)	Dose Conversion Factor (DF)				GI Tract
		Total Body	Bone	Thyroid	Liver	
Y-92	2.5E+01	2.5E-11	8.5E-10	___(3)	___(3)	1.5E-05
Y-93	2.5E+01	7.4E-11	2.7E-09	___(3)	___(3)	8.5E-05
Zr-95	3.3E+00	6.6E-09	3.1E-08	___(3)	9.8E-09	3.1E-05
Nb-95	3.0E+04	1.9E-09	6.2E-09	___(3)	3.5E-09	2.1E-05
Zr-97	3.3E+00	1.6E-10	1.7E-09	___(3)	3.4E-10	1.1E-04
Nb-97	3.0E+04	4.8E-12	5.2E-11	___(3)	1.3E-11	4.9E-08
Mo-99	1.0E+01	8.2E-07	___(3)	___(3)	4.3E-06	1.0E-05
Tc-99m	1.5E+01	8.9E-09	2.5E-10	___(3)	7.0E-10	4.1E-07
Tc-101	1.5E+01	3.6E-09	2.5E-10	___(3)	3.7E-10	1.1E-21
Ru-103	1.0E+01	8.0E-08	1.9E-07	___(3)	___(3)	2.2E-05
Ru-105	1.0E+01	6.1E-09	1.5E-08	___(3)	___(3)	9.4E-06
Rh-105	1.0E+01	5.8E-08	1.2E-07	___(3)	8.9E-08	1.4E-05
Ru-106	1.0E+01	3.5E-07	2.8E-06	___(3)	___(3)	1.8E-04
Ag-110m	2.3E+00	8.8E-08	1.6E-07	___(3)	1.5E-07	6.0E-05
Sb-124	1.0E+00	1.1E-06	2.8E-06	6.8E-09	5.3E-08	8.0E-05
Sb-125	1.0E+00	4.3E-07	1.8E-06	1.8E-09	2.0E-08	2.0E-05
Sb-126	1.0E+00	4.2E-07	1.2E-06	7.0E-09	2.3E-08	9.4E-05
Sb-127	1.0E+00	9.9E-08	2.6E-07	3.1E-09	5.7E-09	5.9E-05
Te-127	4.0E+02	2.4E-08	1.1E-07	8.2E-08	4.0E-08	8.7E-06
Te-129m	4.0E+02	1.8E-06	1.2E-05	4.0E-06	4.3E-06	5.8E-05
Te-129	4.0E+02	7.7E-09	3.1E-08	2.4E-08	1.2E-08	2.4E-08
Te-131m	4.0E+02	7.1E-07	1.7E-06	1.3E-06	8.5E-07	8.4E-05
Te-131	4.0E+02	6.2E-09	2.0E-08	1.6E-08	8.2E-09	2.8E-09
Te-132	4.0E+02	1.5E-06	2.5E-06	1.8E-06	1.6E-06	7.7E-05
I-131	1.5E+01	3.4E-06	4.2E-06	2.0E-03	6.0E-06	1.6E-06
I-132	1.5E+01	1.9E-07	2.0E-07	1.9E-05	5.4E-07	1.0E-07
I-133	1.5E+01	7.5E-07	1.4E-06	3.6E-04	2.5E-06	2.2E-06
I-134	1.5E+01	1.0E-07	1.1E-07	5.0E-06	2.9E-07	2.5E-10

Table 2-1

FISH BIOACCUMULATION FACTORS (BF)⁽¹⁾
AND ADULT INGESTION DOSE CONVERSION FACTORS (DF)⁽²⁾

Nuclide	Fish Bioaccumulation Factor (BF) (pCi/kg per pCi/liter)	Dose Conversion Factor (DF)				
		Total Body	Bone	Thyroid	Liver	GI Tract
I-135	1.5E+01	4.3E-07	4.4E-07	7.7E-05	1.2E-06	1.3E-06
Cs-134	2.0E+03	1.2E-04	6.2E-05	___(3)	1.5E-04	2.6E-06
Cs-136	2.0E+03	1.9E-05	6.5E-06	___(3)	2.6E-05	2.9E-06
Cs-137	2.0E+03	7.1E-05	8.0E-05	___(3)	1.1E-04	2.1E-06
Cs-138	2.0E+03	5.4E-08	5.5E-08	___(3)	1.1E-07	4.7E-13
Ba-139	4.0E+00	2.8E-09	9.7E-08	___(3)	6.9E-11	1.7E-07
Ba-140	4.0E+00	1.3E-06	2.0E-05	___(3)	2.6E-08	4.2E-05
La-140	2.5E+01	3.3E-10	2.5E-09	___(3)	1.3E-09	9.3E-05
La-141	2.5E+01	1.6E-11	3.2E-10	___(3)	9.9E-11	1.2E-05
La-142	2.5E+01	1.5E-11	1.3E-10	___(3)	5.8E-11	4.3E-07
Ce-141	1.0E+00	7.2E-10	9.4E-09	___(3)	6.3E-09	2.4E-05
Ce-143	1.0E+00	1.4E-10	1.7E-09	___(3)	1.2E-06	4.6E-05
Ce-144	1.0E+00	2.6E-08	4.9E-07	___(3)	2.0E-07	1.7E-04
Pr-143	2.5E+01	4.6E-10	9.2E-09	___(3)	3.7E-09	4.0E-05
Nd-147	2.5E+01	4.4E-10	6.2E-09	___(3)	7.3E-09	3.5E-05
Hf-179m	3.3E+00	4.8E-06	___(3)	___(3)	___(3)	4.1E-05
Hf-181	3.3E+00	4.3E-06	___(3)	___(3)	___(3)	4.1E-05
W-185	1.2E+03	1.4E-08	4.1E-07	___(3)	1.4E-07	1.6E-05
W-187	1.2E+03	3.0E-08	1.0E-07	___(3)	8.6E-08	2.8E-05
Np-239	1.0E+01	6.5E-11	1.2E-09	___(3)	1.2E-10	2.4E-05

⁽¹⁾NRC NUREG/CR-4013.

⁽²⁾NRC NUREG/CR-4013.

⁽³⁾No data listed in NUREG/CR-4013.
(Use total body dose conversion factor as an approximation.)

Table 2-2

INGESTION DOSE FACTORS (A_{ij}) FOR TOTAL BODY AND CRITICAL ORGAN
(in mrem/hr per $\mu\text{Ci/ml}$)

Liquid Effluent

<u>Nuclide</u>	<u>Total Body</u>	<u>Bone</u>	<u>Thyroid</u>	<u>Liver</u>	<u>GI Tract</u>
H-3	1.8E-01	**	1.8E-01	1.8E-01	1.8E-01
Na-24	4.1E+02	4.1E+02	4.1E+02	4.1E+02	4.1E+02
P-32	1.8E+06	4.6E+07	**	2.9E+06	5.3E+06
Cr-51	1.3E+00	**	7.7E-01	**	3.2E+02
Mn-54	8.3E+02	**	**	4.4E+03	1.3E+04
Mn-56	1.9E+01	**	**	1.6E+02	3.6E+03
Fe-55	1.1E+02	6.7E+02	**	4.6E+02	2.6E+02
Fe-59	9.4E+02	1.0E+03	**	2.4E+03	8.2E+03
Co-58	2.1E+02	**	**	9.0E+01	1.8E+03
Co-60	5.7E+02	**	**	2.5E+02	4.8E+03
Ni-65	7.5E+00	1.3E+02	**	1.7E+01	4.1E+02
Cu-64	4.7E+00	**	**	1.0E+01	8.6E+02
Zn-65	3.4E+04	2.3E+04	**	7.2E+04	4.7E+04
Zn-69m	1.8E+02	8.1E+02	**	2.0E+03	1.2E+05
As-76	1.2E+03	**	**	**	1.1E+04
Br-82	2.3E+03	**	**	**	2.6E+03
Br-83	4.0E+01	**	**	**	5.8E+01
Br-84	5.2E+01	**	**	**	4.1E-04
Rb-89	1.3E+02	**	**	1.9E+02	1.1E-11
Sr-89	6.4E+02	2.3E+04	**	**	3.6E+03
Sr-90	1.3E+04	6.3E+05	**	**	1.6E+04
Sr-91	1.7E+01	4.1E+02	**	**	2.0E+03
Sr-92	6.8E+00	1.6E+02	**	**	3.1E+03
Y-90	1.6E-02	5.9E-01	**	**	6.1E+03
Y-91m	2.1E-04	5.5E-03	**	**	1.6E-02
Y-91	2.3E-01	8.5E+00	**	**	4.7E+03
Y-92	1.5E-03	5.2E-02	**	**	9.1E+02
Y-93	4.5E-03	1.6E-01	**	**	5.2E+03

Table 2-2

INGESTION DOSE FACTORS (A_{ij}) FOR TOTAL BODY AND CRITICAL ORGAN
(in mrem/hr per μ Ci/ml)

<u>Nuclide</u>	<u>Liquid Effluent</u>				
	<u>Total Body</u>	<u>Bone</u>	<u>Thyroid</u>	<u>Liver</u>	<u>GI Tract</u>
Zr-95	5.3E-02	2.5E-01	**	7.9E-02	2.5E+02
Nb-95	1.4E+02	4.5E+02	**	2.5E+02	1.5E+06
Zr-97	1.3E-03	1.4E-02	**	2.7E-03	8.8E+02
Nb-97	3.5E-01	3.7E+00	**	9.3E-01	3.5E+03
Mo-99	2.0E+01	**	**	1.1E+02	2.5E+02
Tc-99m	3.3E-01	9.2E-03	**	2.6E-02	1.5E+01
Tc-101	1.3E-01	9.2E-03	**	1.4E-02	4.0E-14
Ru-103	2.0E+00	4.7E+00	**	**	5.5E+02
Ru-105	1.5E-01	3.7E-01	**	**	2.3E+02
Rh-105	1.4E+00	3.0E+00	**	2.2E+00	3.5E+02
Ru-106	8.7E+00	6.9E+01	**	**	4.5E+03
Ag-110m	5.6E-01	1.0E-00	**	9.5E-01	3.8E+02
Sb-124	3.6E+00	9.0E+00	2.2E-02	1.7E-01	2.6E+02
Sb-125	1.4E+00	5.8E+00	5.8E-03	6.5E-02	6.5E+01
Sb-126	1.4E+00	3.9E+00	2.3E-02	7.4E-02	3.0E+02
Sb-127	3.2E-01	8.4E-01	1.0E-02	1.8E-02	1.9E+02
Te-127	2.3E+01	1.1E+02	7.9E+01	3.8E+01	8.3E+03
Te-129m	1.7E+03	1.2E+04	3.8E+03	4.1E+03	5.6E+04
Te-129	7.4E+00	3.0E+01	2.3E+01	1.2E+01	2.3E+01
Te-131m	6.8E+02	1.6E+03	1.3E+03	8.2E+02	8.1E+04
Te-131	5.9E+00	1.9E+01	1.5E+01	7.9E+00	2.7E+00
Te-132	1.4E+03	2.4E+03	1.7E+03	1.5E+03	7.4E-04
I-131	1.3E+02	1.5E+02	7.4E+04	2.2E+02	5.9E+01
I-132	7.0E+00	7.4E+00	7.0E+02	2.0E+01	3.7E+00
I-133	2.8E+01	5.1E+01	1.3E+04	9.2E+01	8.1E+01
I-134	3.7E+00	4.0E+00	1.8E+02	1.1E+01	9.2E-03
I-135	1.6E+01	1.6E+01	2.8E+03	4.4E+01	4.8E+01
Cs-134	5.8E+05	3.0E+05	**	7.2E+05	1.3E+04
Cs-136	9.1E+04	3.1E+04	**	1.3E+05	1.4E+04
Cs-137	3.4E+05	3.8E+05	**	5.3E+05	1.0E+04
Cs-138	2.6E+02	2.6E+02	**	5.3E+02	2.3E-03

Table 2-2

INGESTION DOSE FACTORS (A_{if}) FOR TOTAL BODY AND CRITICAL ORGAN
(in mrem/hr per $\mu\text{Ci/ml}$)

Liquid Effluent

<u>Nuclide</u>	<u>Total Body</u>	<u>Bone</u>	<u>Thyroid</u>	<u>Liver</u>	<u>GI Tract</u>
Ba-139	2.9E-02	1.0E-00	**	7.2E-04	1.8E+00
Ba-140	1.4E+01	2.1E+02	**	2.7E-01	4.4E+02
La-140	2.0E-02	1.5E-01	**	7.9E-02	5.6E+03
La-141	9.7E-04	1.9E-02	**	6.0E-03	7.3E+02
La-142	9.1E-04	7.9E-03	**	3.5E-03	2.6E+01
Ce-141	2.3E-03	3.0E-02	**	2.0E-02	7.7E+01
Ce-143	4.5E-04	5.5E-03	**	3.9E+00	1.5E+02
Ce-144	8.4E-02	1.6E+00	**	6.5E-01	5.5E+02
Pr-143	2.8E-02	5.6E-01	**	2.3E-01	2.4E+03
Nd-147	2.7E-02	3.8E-01	**	4.4E-01	2.1E+03
Hf-179m	4.2E+01	**	**	**	3.6E+02
Hf-181	3.8E+01	**	**	**	3.6E+02
W-185	4.0E+01	1.2E+03	**	4.0E+02	4.6E+04
W-187	8.6E+01	2.9E+02	**	2.5E+02	8.1E+04
Np-239	1.6E-03	3.0E-02	**	3.0E-03	6.0E+02

**No Ingestion Dose Factor (DF_i) is listed in NUREG/CR-4013. (Total body dose factor value will be used as an approximation.)

TABLE 2-3

INPUT PARAMETERS USED TO CALCULATE MAXIMUM INDIVIDUAL DOSE
FROM LIQUID EFFLUENTS

Drinking Water

River Dilution:	50,000		
River Transit Time:	4 hours		
Usage Factors:	Adult = 730 1/yr	Teenager = 510 1/yr	
	Child = 510 1/yr	Infant = 330 1/yr	

Boating and Aquatic Food

River Dilution:	500		
Transit Time:	2 hours		
Usage Factors: (Aquatic Food)	Adult = 21 kg/yr	Teenager = 16 kg/yr	
	Child = 6.9 kg/yr	Infant = 0	
(Boating)	Adult = 100 hr/yr	Teenager = 100 hr/yr	
	Child = 85 hr/yr	Infant = 0	

Recreation

River Dilution:	20,000		
Shoreline Width Factor:	0.2		
Usage Factors:	Shoreline Activities:	Adult = 90 hr/yr	
		Teenager = 500 hr/yr	
		Child = 105 hr/yr	
		Infant = 0	
	Swimming:	Adult = 18 hr/yr	
		Teenager = 100 hr/yr	
		Child = 21 hr/yr	

Irrigated Foodstuffs

River Dilution:	50,000			
River Transit Time:	4 hours			
Food Delivery Time:	<u>Vegetables</u> 14 days	<u>Milk</u> 48 hours	<u>Meat</u> 20 days	<u>Leafy Vegetables</u> 24 hours
Usage Factors:				
Adult	520 kg/yr	310 1/yr	110 kg/yr	64 kg/yr
Teenager	630 kg/yr	400 1/yr	65 kg/yr	42 kg/yr
Child	520 kg/yr	330 1/yr	41 kg/yr	26 kg/yr
Monthly Irrigation Rate:	180 1/m ²	200 1/m ²	160 1/m ²	200 1/m ²
Annual Yield:	5.0 kg/m ²	1.3 1/m ²	2.0 kg/m ²	1.5 kg/m ²
Annual Growing Period:	70 days	30 days	130 days	70 days
Annual 50-Mile Production:	3.5E+09 kg	2.8E+08 L	2.3E+07 kg	1.9E+06 kg

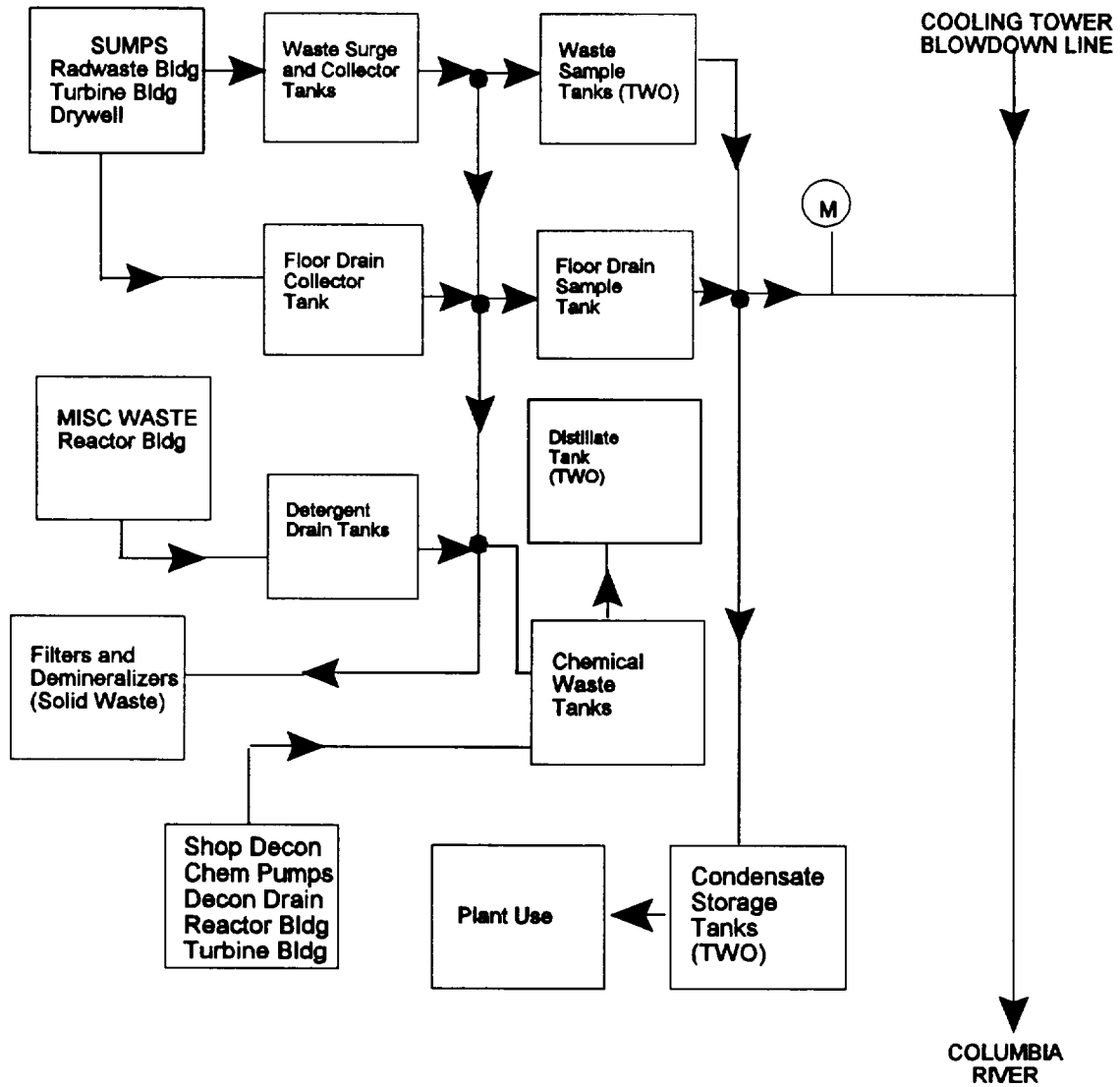

SIMPLIFIED BLOCK DIAGRAM OF
LIQUID WASTE SYSTEM

Figure 2-1

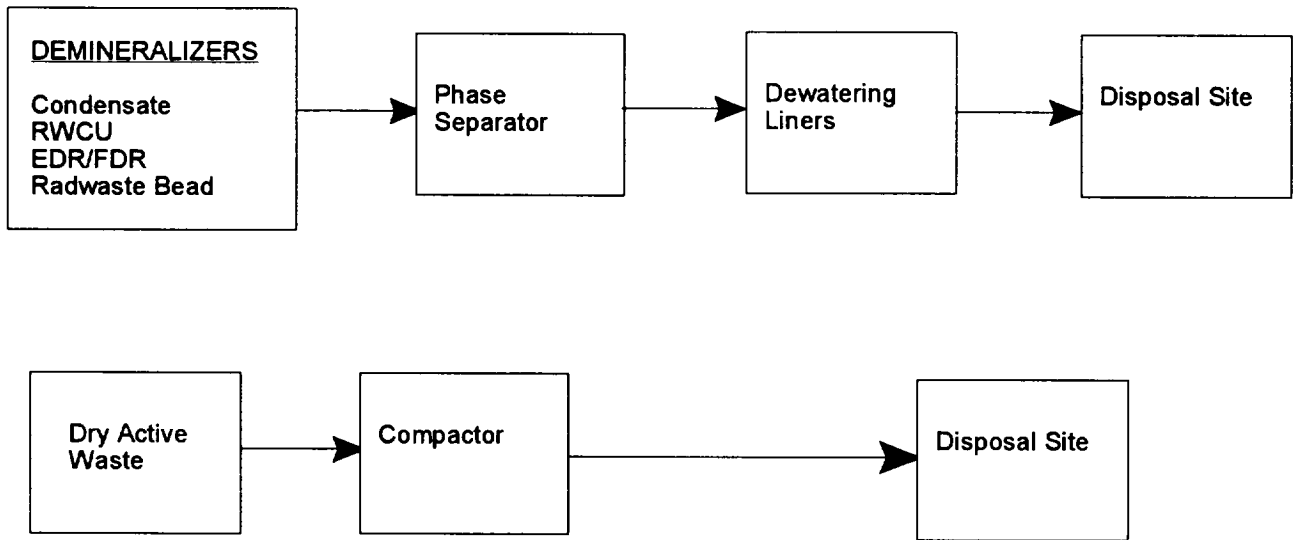

SIMPLIFIED BLOCK DIAGRAM OF
SOLID RADWASTE SYSTEM

Figure 2-2

3.0 GASEOUS EFFLUENTS DOSE CALCULATIONS

The U.S. Nuclear Regulatory Commission's computer program GASPAR II can be used to perform environmental dose analyses for releases of radioactive effluents from WNP-2 into the atmosphere. The analyses estimate radiation dose to individuals and population groups from inhalation, ingestion (terrestrial foods), and external exposure (ground and plume) pathways. The calculated doses provide information for determining compliance with Appendix I of 10 CFR Part 50. This computer code has the subroutine "PARTS" which can be used for calculating dose factors.

The NRC computer program GASPAR II supplements the ODCM in monthly, quarterly and annual dose equivalent determinations from gaseous effluents. The method which is normally employed to calculate the annual dose to the maximally exposed organ sums the dose to the maximally exposed organ for each quarter. As a result, the maximum annual organ dose may not represent the maximum dose to any one particular organ for that particular year. Actual specific organ doses will be less than or equal to this calculated value.

Both the ODCM equations and the NRC GASPAR II computer program for estimating the highest dose to any organ for a particular age group provides conservatism in calculating maximum organ doses. This conservatism is recognized and is intentional.

3.1 Introduction

WNP-2 gaseous effluents are released on a continuous basis; in addition, batch releases also occur when containment and mechanical vacuum pump purges are performed and when the off-gas treatment system operates in the charcoal bypass mode. The gaseous effluents released from WNP-2 will meet Requirement for Operability at the site boundary.

Figure 3-1 delineates the WNP-2 Site boundary, which for dose calculation purposes, is considered circular with a radius of 1.2 miles. There are several low occupancy unrestricted locations within the site boundary. These locations, with the exception of the WNP-2 visitor center, are not continuously controlled by Energy Northwest. The locations are:

1. Wye burial site - normally controlled by DOE.
2. DOE train - two railroad lines pass through the site (approximately 3 miles of line). According to DOE, the train makes one round trip a day, through the site at an average speed of 20 mph, 5 days a week, 52 weeks/year.
3. BPA Ashe Substation - occupied 2080 hours/year. These people are not normally controlled by Energy Northwest but are involved in activities directly in support of WNP-2.

4. WNP-2 - Energy Northwest Visitor Center - assumed occupied 8 hrs/yr by non-Energy Northwest individuals.
5. WNP-1 - occupied 2080 hrs/yr. This location is controlled by Energy Northwest. However, activities are not in direct support of WNP-2.
6. WNP-4 - occupied 2080 hrs/yr. This location is controlled by Energy Northwest. However, activities are not in direct support of WNP-2.

All other locations listed in Figure 3-1 support WNP-2 activities and are controlled by Energy Northwest. Figure 3-2 provides a simplified block diagram of the gaseous radwaste system for the reactor, turbine and radwaste buildings. Figure 3-3 provides a simplified block diagram for the off-gas treatment system.

Air doses and doses to individuals at these locations were calculated based on the NRC GALE code design base mixture, location specific estimated occupancy, and X/Qs from XOQDOQ. (Note: Desert Sigmas were used in calculating X/Q and D/Q values, and are listed in Table 3-10 and 3-11). These doses are listed in Tables 3-16 and 3-17 along with the doses to the maximum exposed individual.

The most likely exposed member of the public is considered to be residing in Taylor Flats (4.2 miles ESE of WNP-2). This is the closest residential area with the highest X/Q and D/Q values.

The Auxiliary Boiler supplies heating steam to the Reactor, Radwaste, Turbine and Service buildings when Seal Steam Evaporator B is not in operation. The Auxiliary Boiler and associated heating steam system vents to the atmosphere and provides a possible unmonitored source of radioactive effluent when in operation. Samples have shown $2.0 \text{ E}+06$ picocuries per liter of tritium activity to be present within the Auxiliary Boiler system. Using NRC Regulatory Guide 1.109 methodology with FSAR Low Population Zone (LPZ) X/Q values and assuming one gallon per minute (1 gpm) makeup flowrate for 180 days plus a one time complete boil-off of the total water inventory, the dose contribution from tritium would be less than one tenth of a millirem per year ($<0.1 \text{ mrem/yr}$). Figure 3-4 provides a simplified diagram for the Auxiliary Boiler.

Tritium in the form of tritiated water vapor is released to the environment through monitored/sampled effluent pathways. Under certain meteorological conditions, the tritiated water vapor may condense onto surfaces such as rooftops and parking lots. Subsequently, this condensed, recaptured tritiated water may be carried with precipitation into the Storm Drain Pond (SDP) which serves as a collection point for storm drainage. In addition, tritiated water vapor released onto WNP-2 buildings may condense on cold metal exterior walls and run onto adjacent rooftops, to be carried with precipitation to the SDP. Influent to the SDP is continuously sampled and periodically analyzed for tritium content.

3.2 Gaseous Effluent Radiation Monitoring System

3.2.1 Main Plant Release Point

The Main Plant Release is instrument monitored for gaseous radioactivity prior to discharge to the environment via the main plant vent release point. Particulates and iodine activity are accumulated in filters which will be changed and analyzed as per Periodic Test and Inspection 6.2.2.1.2 and Table 6.2.2.1.2-1. The effluent is supplied from: the gland seal exhaust, mechanical vacuum pumps, treated off gas, standby gas treatment, and exhaust air from the entire reactor building's ventilation.

Two 100-percent capacity vanaxial fans supply 80,000 CFM ventilation air. One is normally operating, the other is in standby. The radiation monitors are located on the ventilation exhaust plenum.

Effluent monitoring consists of a gamma spectroscopy system which provides an isotopic analysis of the Elevated Release effluents. The low range (PRM-RE-1A) is a high efficiency, cryogenically cooled, high purity germanium detector located inside the duct at elevation 611' to monitor low level normal operation radioactivity. Low range response is approximately 8.0×10^8 cps/ $\mu\text{Ci/cc}$. PRM-RE-1A has a gross gamma Log Count Rate Meter range of 10 to 10^6 cps, located on Radwaste Building elevation 525' in PRM-CP-1, and is recorded on PRM-RR-3 on BD-RAD-24 in the Main Control Room. Power is from battery-backed, reliable 120 VAC buses. This monitor has no control function but annunciates in the Main Control Room. The alarm will initiate proper action as defined in the WNP-2 plant procedures.

3.2.2 Radwaste Building Ventilation Exhaust Monitor

The radwaste building ventilation exhaust monitoring system monitors the radioactivity in the exhaust air prior to discharge. Radioactivity can originate from: radwaste tank vents, laboratory hoods, and various cubicles housing liquid process treatment equipment and systems.

The radwaste building exhaust system has three 50-percent capacity exhaust filter units of 42,000 cfm capacity. Each exhaust unit has a medium-efficiency prefilter, a high efficiency particulate air filter (HEPA) and two centrifugal fans. Total exhaust flow will vary as the combined exhaust unit maintains a radwaste building differential pressure of -0.25 inches H_2O to the environment.

Particulate and iodine air sample filters are changed weekly for laboratory analysis. After the particulate and iodine filters, the air sample streams are combined in a manifold prior to being monitored by a beta scintillator.

The beta scintillators, on the 487' level are mounted in lead shielded chambers. The low range beta scintillator has an approximate response of 80 cpm/pCi/cc to Kr-85, and 50 cpm/pCi/cc to Xe-133 and a meter range of $10 - 10^7$ cpm. The intermediate range has a response from $10^{-2} - 10^3$ μ Ci/cc Xe-133 equivalent, and reads in panel meter units (PMU) with a meter range of $10^0 - 10^5$ PMU. The readouts and recorder are located in the main control room panel BD-RAD-24. Power is provided from 125 VDC divisional buses. This monitor has no control functions but annunciates in the main control room. The alarm will initiate proper action as defined in the WNP-2 plant procedures.

3.2.3 Turbine Building Ventilation Exhaust Monitor

This monitoring system detects fission and the activation products from the turbine building air which may be present due to leaks from the turbine and other primary components in the building.

The turbine building main exhaust system consists of four roof-mounted centrifugal fans which draw air from a central exhaust plenum. Three fans operate, with one in standby to provide a flow of 360,000 cfm during summer months, and two fans operate with two in standby to provide a flow of 240,000 cfm during winter months.

A representative sample is extracted from the exhaust vent and passed through a particulate and charcoal filter. The air sample then passes to a beta scintillator.

The beta scintillators are mounted in lead shielded chambers. The low range beta scintillator has an approximate response of 80 cpm/pCi/cc to Kr-85, and 50 cpm/pCi/cc to Xe-133 and a meter range of $10 - 10^7$ cpm. The intermediate range has a response from $10^{-2} - 10^3$ μ Ci/cc Xe-133 equivalent, and reads in panel meter units (PMU) with a meter range of $10^0 - 10^5$ PMU. The monitors are on the 525' level of the radwaste building and the readouts and the recorder are located in the main control room panel BD-RAD-24. Power is provided from the 125 VDC divisional buses. This monitor has no control functions but annunciates in the main control room. The alarm will initiate proper action as defined in the WNP-2 plant procedures.

3.3 10 CFR 20 Release Rate Limits

Limits for release of gaseous effluents from the site to areas at and beyond the site boundary are stated in Requirement for Operability 6.2.2.1. The dose rate at these areas due to radioactive materials released in gaseous effluents from the site shall be limited to the following values:

- (a) "The dose rate limit for noble gases shall be ≤ 500 mrem/yr to the total body and ≤ 3000 mrem/yr to the skin."

- (b) "The dose rate limit for all radioiodines and for all radioactive materials in particulate form and radionuclides other than noble gases with half-lives greater than eight days shall be ≤ 1500 mrem/yr to any organ."

3.3.1 Noble Gases

In order to comply with Requirement for Operability 6.2.2.1, the following equations must hold:

Whole body:

$$\sum_i K_i \left[(\overline{X/Q})_m \dot{Q}_{im} + (\overline{X/Q})_g \dot{Q}_{ig} \right] \leq 500 \text{ mrem/yr} \quad (1)$$

Skin:

$$\sum_i \left[(L_i + 1.1M_i) \left((\overline{X/Q})_m \dot{Q}_{im} + (\overline{X/Q})_g \dot{Q}_{ig} \right) \right] \leq 3000 \text{ mrem/yr} \quad (2)$$

3.3.2 Radioiodines and Particulates

Part "b" of Requirement for Operability 6.2.2.1 requires that the release rate limit for all radioiodines and radioactive materials in particulate form and radionuclides other than noble gases must meet the following relationship:

Any organ:

$$\sum_i P_i \left[W_M \dot{Q}_{im} + W_g \dot{Q}_{ig} \right] \leq 1500 \text{ mrem/yr} \quad (3)$$

The terms used in Equations (1) through (3) are defined as follows:

- K_i = The total body dose factor due to gamma emissions for each identified noble gas radionuclide i (mrem/yr per $\mu\text{Ci}/\text{m}^3$).
- L_i = The skin dose factor due to beta emissions for each identified noble gas radionuclide i (mrem/yr per $\mu\text{Ci}/\text{m}^3$).
- M_i = The air dose factor due to gamma emissions for each identified noble gas radionuclide in mrad/yr per $\mu\text{Ci}/\text{m}^3$ (unit conversion constant of 1.1 mrem/mrad converts air dose to skin dose).

- P_i = The dose parameter for all radionuclides other than noble gases for the inhalation pathway, (mrem/yr per $\mu\text{Ci}/\text{m}^3$) and for food and ground plane pathways, $\text{m}^2(\text{mrem}/\text{yr per } \mu\text{Ci}/\text{sec})$. The dose factors are based on the critical individual organ and the most restrictive age group.
- \dot{Q}_{im} = The release rate of radionuclide i in gaseous effluent from mixed mode release. The main plant release point is a partially elevated mixed mode release ($\mu\text{Ci}/\text{sec}$).
- \dot{Q}_{ig} = The release rate of radionuclide i in gaseous effluent from all ground level releases ($\mu\text{Ci}/\text{sec}$).
- $(\overline{X/Q})_m$ = (sec/m^3). For partially elevated mixed mode releases from the main plant vent release point. The highest calculated partially elevated annual average relative concentration for any area at and beyond the site boundary.
- $(\overline{X/Q})_g$ = (sec/m^3). For all Turbine Building and Radwaste releases. The highest calculated ground level annual average relative concentration for any area at and beyond the site boundary.
- W_g = The highest calculated annual average dispersion parameter for estimating the dose to an individual at the controlling location due to all ground level releases.
- W_g = (sec/m^3). For the inhalation pathway. The location is at and beyond the site boundary in the sector of maximum concentration.
- W_g = m^2 . For ground plane pathways. The location is at and beyond the site boundary in the sector of maximum concentration.
- W_M = The highest calculated annual average dispersion parameter for estimating the dose to an individual at the controlling location due to partially elevated releases:
- W_M = sec/m^3 . For inhalation pathway. The location is at and beyond the site boundary in the sector of maximum concentration.
- W_M = m^2 . For ground plane pathways. The location is at and beyond the site boundary in the sector of maximum concentration.

The factors, L_i and M_i , relate the radionuclide airborne concentrations to various dose rates assuming a semi-infinite cloud. These factors are listed in Table B-1 of Regulatory Guide 1.109, Revision 1, and in Table 3-1 of this manual.

The values used in the equations for the implementation of Requirement for Operability 6.2.2.1 are based upon the maximum long-term annual average X/Q at and beyond the site boundary. Table 3-2 provides typical locations based on the current Land Use Census with pathways for use in dose determinations. Table 3-3 provides these typical locations with long term X/Q and D/Q values which may be used if current annual averages are not available.

The X/Q and D/Q values listed in Tables 3-10 and 3-11 reflecting correctly acquired meteorological data, January 1, 1984 - January 1, 1990 may be utilized in GASPAR II Computer runs.

3.3.2.1 Dose Parameter for Radionuclide i (P_i)

The dose parameters used in Equation (3) are based on:

1. Inhalation and ground plane. (Note: Food pathway is not applicable to WNP-2 since no food is grown at or near the restricted area boundary.)
2. The annual average continuous release meteorology at the site boundary.
3. The critical organ for each radionuclide (thyroid for radioiodine).
4. The most restrictive age group.

Calculation of P_i^I (Inhalation): The following equation will be used to calculate P_i^I (Inhalation).

$$P_i^I \text{ (Inhalation)} = K^A(BR) DFA_i \text{ (mrem/yr per } \mu\text{Ci/m}^3\text{)} \quad (5)$$

where:

- K^A = A constant of conversion, 10^6 pCi/ μ Ci.
- BR = The breathing rate of the child age group, 3700 m³/yr.
- DFA_i = The critical organ inhalation dose factor for the child age group for the i th radionuclide in mrem/pCi. The total body is considered as an organ in the selection of DFA_i .

The inhalation dose factor for DFA_i for the child age group is listed in Table E-9 of Regulatory Guide 1.109, Revision 1, and Table 3-4 of this manual. Resolving the units yields:

$$P_i^I = (\text{Inhalation}) = (3.7 \times 10^9) (DFA_i) (\text{mrem/yr per } \mu\text{Ci/m}^3) \quad (6)$$

The P_i^I (Inhalation) values for the child age group are tabulated in Table 3-4 of this manual.

3.4 10 CFR 50 Release Rate Limits

The requirements pertaining to 10 CFR 50 release rate limits are specified in Requirement for Operability 6.2.2.2 and 6.2.2.3.

Requirement for Operability 6.2.2.2 deals with the air dose from noble gases and requires that the air dose at and beyond the site boundary due to noble gases released in gaseous effluents shall be limited to the following:

- (a) "During any calendar quarter, to ≤ 5 mrad for gamma radiation and to ≤ 10 mrad for beta radiation."
- (b) "During any calendar year, to ≤ 10 mrad for gamma radiation and ≤ 20 mrad for beta radiation."

Requirement for Operability 6.2.2.3 deals with radioiodines, tritium, and radioactive materials in particulate form, and requires that the dose to an individual from radioiodines, tritium and radioactive materials in particulate form with half-lives greater than eight days in gaseous effluents released to unrestricted areas shall be limited to the following:

- (a) "During any calendar quarter, to ≤ 7.5 mrem."
- (b) "During any calendar year, to ≤ 15 mrem."

3.4.1 Noble Gases (Requirement for Operability 6.2.2.2)

The air dose at and beyond the site boundary due to noble gases released in the gaseous effluent will be determined by using the following equations.

- a. During any calendar quarter, for gamma radiation:

$$3.17 \times 10^{-8} \sum_i \left[M_i (\overline{X/Q})_g Q_{ig} + (X/q)_g q_{ig} + (\overline{X/Q})_m Q_{im} + (X/q)_m q_{im} \right] \leq 5 \text{ mrad} \quad (8)$$

During any calendar quarter, for beta radiation:

$$3.17 \times 10^{-8} \sum_i N_i \left[(\overline{X/Q})_g Q_{ig} + (X/q)_g q_{ig} + (\overline{X/Q})_m Q_{im} + (X/q)_m q_{im} \right] \leq 10 \text{ mrad} \quad (9)$$

b. During any calendar year, for gamma radiation:

$$3.17 \times 10^{-8} \sum_i M_i \left[(\overline{X/Q})_g Q_{ig} + (X/q)_g q_{ig} + (\overline{X/Q})_m Q_{im} + (X/q)_m q_{im} \right] \leq 10 \text{ mrad} \quad (10)$$

During any calendar year, for beta radiation:

$$3.17 \times 10^{-8} \sum_i N_i \left[(\overline{X/Q})_g Q_{ig} + (X/q)_g q_{ig} + (\overline{X/Q})_m Q_{im} + (X/q)_m q_{im} \right] \leq 20 \text{ mrad} \quad (11)$$

where:

- M_i = The air dose factor due to gamma emissions for each identified noble gas radionuclide, in mrad/yr per $\mu\text{Ci}/\text{m}^3$ (M_i values are listed in Table 3-1).
- N_i = The air dose factor due to beta emissions for each identified noble gas radionuclide, in mrad/yr per $\mu\text{Ci}/\text{m}^3$ (N_i values are listed in Table 3-1).
- $(\overline{X/Q})_g$ = For ground level release points. The highest calculated annual average relative concentration for area at and beyond the site area boundary for long-term releases (greater than 500 hr/yr). (Sec/m^3)
- $(X/q)_g$ = For ground level release points. The relative concentration for areas at and beyond the site area boundary for short-term releases (equal to or less than 500 hr/yr). (Sec/m^3)
- $(\overline{X/Q})_m$ = For partially elevated release points. The highest calculated annual average relative concentration for areas at and beyond the site boundary for long-term releases (greater than 500 hr/yr). (Sec/m^3)
- $(X/q)_m$ = For partially elevated release points. The relative concentration for areas at and beyond the site boundary for short-term releases (equal to or less than 500 hr/yr). (Sec/m^3)

q_{im} = The average release of noble gas radionuclides in gaseous effluents, i , for short-term releases (equal to or less than 500 hr/yr) from the main plant release point, in μCi . Releases shall be cumulative over the calendar quarter or year, as appropriate.

q_{ig} = The average release of noble gas radionuclides in gaseous effluents, i , for short-term releases (equal to or less than 500 hr/yr) from Radwaste and Turbine Building, in μCi . Releases shall be cumulative over the calendar quarter or year, as appropriate.

Q_{im} = The average release of noble gas radionuclides in gaseous releases, i , for long-term releases (greater than 500 hr/yr) from the main plant release point, in μCi . Release shall be cumulative over the calendar quarter or year, as appropriate.

Q_{ig} = The average release of noble gas radionuclides in gaseous effluents, i , for long-term releases (greater than 500 hr/yr) from Radwaste and Turbine Building, in μCi . Releases shall be cumulative over the calendar quarter or year, as appropriate.

3.17×10^{-8} = The inverse of the number of seconds in a year.

3.4.2 Radioiodines, Tritium and Particulates Requirement for Operability 6.2.2.3

The following equation calculates the dose to an individual from radioiodines, tritium, and radioactive material in particulate form with half-lives greater than eight days in gaseous effluents released to the unrestricted areas:

a. During any calendar quarter:

$$3.17 \times 10^{-8} \sum_i R_i [W_m Q_{im} + w_m q_{im} + W_g Q_{ig} + w_g q_{ig}] \leq 7.5 \text{ mrem} \quad (12)$$

b. During any calendar year:

$$3.17 \times 10^{-8} \sum_i R_i [W_m Q_{im} + w_m q_{im} + W_g Q_{ig} + w_g q_{ig}] \leq 15 \text{ mrem} \quad (13)$$

where:

- Q_{im}, Q_{ig} = The releases of radionuclides, radioactive materials in particulate form, and radionuclides other than noble gases in gaseous effluents, i, for long-term releases greater than 500 hr/yr, in μCi . Releases shall be cumulative over the calendar quarter or year, as appropriate (m is for mixed mode releases, g is for ground level releases).
- q_{im}, q_{ig} = The releases of radionuclides, radioactive materials in particulate form, and radionuclides other than noble gases in gaseous effluents, i, for short-term releases equal to or less than 500 hr/yr, in μCi . Releases shall be cumulative over the calendar quarter or year as appropriate (m is for mixed mode releases, g is for ground level releases).
- W_m, W_g = The dispersion parameter for estimating the dose to an individual at the controlling location for long-term (greater than 500 hr.) releases (m is for mixed mode releases, g is for ground level releases).
- W_m = $(\overline{X/Q})_m$ for the inhalation pathway, in sec/m^3 .
- W_g = $(\overline{D/Q})_g$ for the food and ground plane pathways in meters^2 .
- w_m, w_g = The dispersion parameter for estimating the dose to an individual at the controlling location for short-term (less than 500 hr.) releases (m is for mixed mode releases, g is for ground level releases).
- w_m = $(\overline{X/q})_m$ for the inhalation pathway, in sec/m^3 .
- w_g = $(\overline{D/q})_g$ for the food and ground plane pathways in meters^2 .
- 3.17×10^{-8} = The inverse of the number of seconds in a year.
- R_i = The dose factor for each identified radionuclide, i, in $\text{m}^2(\text{mrem}/\text{yr per } \mu\text{Ci}/\text{sec})$ or $\text{mrem}/\text{yr per } \mu\text{Ci}/\text{m}^3$.

3.4.2.1 Dose Parameter for Radionuclide i (R_i)

The R_i values used in Equations (12) and (13) of this section are calculated separately for each of the following potential exposure pathways:

- Inhalation
- Ground plane contamination
- Grass-cow/goat-milk pathway
- Grass-cow-meat pathway
- Vegetation pathway

Monthly dose assessments for WNP-2 gaseous effluent will be done for all age groups.

Calculation of R_i^I (Inhalation Pathway Factor)

$$R_i^I (\text{Inhalation}) = K' (BR)_a (DFA)_a \text{ (mrem/yr per } \mu\text{Ci/m}^3\text{)} \quad (14)$$

where:

- R_i^I = The inhalation pathway factor (mrem/yr per μCi/m³).
- K' = A constant of unit conversion, 10⁶ pCi/μCi.
- (BR)_a = The breathing rate of the receptor of age group (a) in meter³/yr. (Infant = 1400, child = 3,700, teen = 8,000, adult = 8,000. From P.32 NUREG-0133).
- (DFA)_a = The maximum organ inhalation dose factor for receptor of age group a for the ith radionuclide (mrem/pCi). The total body is considered as an organ in the selection of (DFA)_a. (DFA)_a values are listed in Tables E-7 through E-10 of Regulatory Guide 1.109 manual, Revision 1 and NUREG/CR-4013. Values of R_i^I are listed in Table 3-5.

Calculation of R_i^G (Ground Plane Pathway Factor)

$$R_i^G (\text{Ground Plane}) = K^A K^B (SF)(DFG)_i (1 - e^{-\lambda t})/\lambda_i \text{ (m}^2 \times \text{mrem/yr per } \mu\text{Ci/sec)} \quad (15)$$

where:

- R_i^G = Ground plane pathway factor ($m^2 \times mrem/yr$ per $\mu Ci/sec$).
- K^A = A conversion constant of (10^6 pCi/ μCi).
- K^B = A conversion constant - (8760 hr/yr).
- λ_i = The decay constant for the i th radionuclide (sec^{-1}).
- t = Exposure time, 6.31×10^8 sec (20 years).
- DFG_i = The ground plane dose conversion factor for the i th radionuclide, as listed in Table E-6 of Regulatory Guide 1.109, Revision 1 and NUREG/CR-4013 ($mrem/hr$ per pCi/ m^2).
- SF = Shielding Factor (dimensionless)--0.7 if building is present, as suggested in Table E-15 of Regulatory Guide 1.109, Revision 1.

The values of R_i^G are listed in Table 3-5 of this manual.

Calculation of R_i^C (Grass-Cow/Goat-Milk Pathway Factor)

$$R_i^C \text{ (Grass-Cow/Goat-Milk Factor)} = K' \frac{Q_F(U_{ap})}{\lambda_i + \lambda_w} F_m(r)(DFL_i)_a \left[\frac{f f_p}{Y_p} + \frac{(1-f f_p)e^{-\lambda_i t}}{Y_s} \right] e^{-\lambda_i t} \quad (16)$$

($m^2 \times mrem/yr$ per $\mu Ci/sec$)

where:

- K' = A constant of unit conversion, 10^6 pCi/ μCi .
- Q_F = The cow/goat consumption rate, in kg/day (wet weight).
- U_{ap} = The receptor's milk consumption rate for age a , in liters/yr.
- Y_p = The agricultural productivity by unit area of pasture feed grass, in kg/ m^2 .

- Y_s = The agricultural productivity by unit area of stored feed, in kg/m².
- F_m = The stable element transfer coefficients, in days/liter.
- r = Fraction of deposited activity retained on feed grass.
- $(DFL_i)_a$ = The maximum organ ingestion dose factor for the i th radionuclide for the receptor in age group a , in mrem/pCi (Tables E-11 to E-14 of Regulatory Guide 1.109, Revision 1 and NUREG/CR-4013).
- λ_i = The decay constant for the i th radionuclide, in sec⁻¹.
- λ_w = The decay constant for removal of activity on leaf and plant surfaces by weathering, 5.73×10^{-7} sec⁻¹ (corresponding to a 14-day half-life).
- t_f = The transport time from pasture to animal, to milk, to receptor, in sec.
- t_h = The transport time from pasture, to harvest, to animal, to milk, to receptor, in sec.
- f_p = Fraction of the year that the cow/goat is on pasture (dimensionless).
- f_s = Fraction of the cow/goat feed that is pasture grass while the cow is on pasture (dimensionless).

NOTE: For radioiodines, multiply R_i^C value by 0.5 to account for the fraction of elemental iodine available for deposition.

The input parameters used for calculating R_i^C are listed in Table 3-6. The individual pathway dose parameters for R_i^C are tabulated in Tables 3-5a through 3-5d.

For Tritium:

In calculating R_T^C pertaining to tritium in milk, the airborne concentration rather than the deposition will be used:

$$R_T^C(\text{Grass-Cow/Goat-Milk Factor}) =$$

$$K^A K^C F_m Q_F U_{ap} (DFL_i)_a [0.75(0.5/H)] \text{ (mrem/yr per } \mu\text{Ci/m}^3\text{)} \quad (17)$$

where:

- K^A = A constant unit conversion, 10^6 pCi/ μ Ci.
 K^C = A constant of unit conversion, 10^3 gm/kg.
 H = Absolute humidity of the atmosphere, in gm/m³.
0.75 = The fraction of total feed that is water.
0.5 = The ratio of the specific activity of the feed grass water to the atmospheric water.

Calculation of R_i^M (Grass-Cow-Meat Pathway Factor)

$$R_i^M \text{ (Grass-Cow-Meat Factor)} = K' \frac{Q_F(U_{ap})}{\lambda_i + \lambda_w} F_f(r)(DFL_i)_a \left[\frac{f_p f_s}{Y_p} + \frac{(1-f_p f_s)e^{-\lambda_i t_h}}{Y_s} \right] e^{-\lambda_i t_f} \quad (18)$$

(m² x mrem/yr per μ Ci/sec)

where:

- K' = A constant unit conversion, 10^6 pCi/ μ Ci.
 F_f = The stable element transfer coefficients, in days/kg.
 U_{ap} = The receptor's meat consumption rate for age a, in kg/yr.
 t_f = The transport time from pasture to receptor, in sec.
 t_h = The transport time from crop field to receptor, in sec.

All other parameters are as defined in Equation 16.

NOTE: For radioiodines, multiply R_i^M value by 0.5 to account for the fraction of elemental iodine available for deposition.

The input parameters used for calculation R_i^M (18) are listed in Table 3-7. The individual pathway dose parameters for R_i^M are tabulated in Tables 3-5a through 3-5d.

For Tritium:

In calculating the R_T^M for tritium in meat, the airborne concentration is used rather than the deposition rate. The following equation is used to calculate the R_T^M values for tritium:

$$R_T^M \text{ (Grass-Cow-Meat Pathway)} = K^A K^C [F_f Q_f U_{ap} (DFL_i)_a] [0.75(0.5/H)] \text{ (mrem/yr per } \mu\text{Ci/m}^3 \text{)} \quad (19)$$

Where the terms are as defined in Equations (16) through (18), R_i^M values for tritium pertaining to the infant age group is zero since there is no meat consumption by this age group.

Calculation of R_i^V (Vegetation Pathway Factor)

$$R_i^V \text{ (Vegetation Pathway Factor)} = K' \left[\frac{(r)}{Y_v(\lambda_i + \lambda_w)} (DFL_i)_a \right] \left[U_a^L f_L e^{-\lambda_i t} + U_a^S f_g e^{-\lambda_i t} \right] \quad (20)$$

(m² x mrem/yr per $\mu\text{Ci/sec}$)

where:

- K' = A constant of unit conversion, $10^6 \text{pCi}/\mu\text{Ci}$.
- U_a^L = The consumption rate of fresh leafy vegetation by the receptor in age group a, in kg/yr.
- U_a^S = The consumption rate of stored vegetation by the receptor in age group a, in kg/yr.
- f_L = The fraction of the annual intake of fresh leafy vegetation grown locally.
- f_g = The fraction of the annual intake of stored vegetation grown locally.

t_L = The average time between harvest of leafy vegetation and its consumption, in seconds.

t_b = The average time between harvest of stored vegetation and its consumption, in seconds.

Y_v = The vegetation area density, in kg/m².

NOTE: For radioiodines, multiply R_i^V value by 0.5 to account for the fraction of elemental iodine available for deposition.

All other items are as defined in Equations (16) through (18).

The input parameters for calculation R_i^V are listed in Table 3-8. The individual pathway dose parameters for R_i^V are tabulated in Tables 3-5a through 3-5d.

For Tritium:

In calculating the R_T^V for tritium, the concentration of tritium in vegetation is based on airborne concentration rather than the deposition rate. The following equation is used to calculate R_T^V for tritium:

$$R_T^V \text{ (Vegetation Pathway Factor) = } K^A K^C [(U_a^L f_L + U_a^S f_g) (DFL_i)_a] [0.75(0.5/H)] \text{ (mrem/yr per } \mu\text{Ci/m}^3\text{)} \quad (21)$$

Where all terms have been defined above and in Equations (16) through (18), the R_T^V value for tritium is zero for the infant age group due to zero vegetation consumption rate by that age group. The input parameters needed for solving Equations (20) and (21) are listed in Table 3-8.

3.4.3 Annual Doses At Special Locations

The Radioactive Effluent Release Report submitted within 60 days after January 1 of each year shall include an assessment of the radiation doses from radioactive gaseous effluents to "Members of the Public," due to their activities inside the site boundary during the report period.

Annual doses within the site boundary have been determined for several locations using the NRC GASPARII computer code and source term data from Table 11.3-7 of the FSAR. These values are listed in Tables 3-16 and 3-17. Of the locations listed within the site boundary, only two, the DOE Train and WNP-2 Visitor Center are considered as being occupied by a "Member of the Public." Annual doses to the maximum exposed "Member of the Public" shall be determined for an individual at the WNP-2 Visitor Center based on occupancy of 8 hours per year due to it being the higher of the two locations.

3.5 Compliance with Requirement for Operability 6.2.2.4

Requirement for Operability 6.2.2.4 states:

"The GASEOUS RADWASTE TREATMENT SYSTEM shall be in operation in either the normal or charcoal bypass mode. The charcoal bypass mode shall not be used unless the offgas post-treatment radiation monitor is OPERABLE as specified in Table 6.1.2.1-1."

"RELEVANT CONDITIONS: Whenever the main condenser steam jet air ejector (evacuation) system is in operation."

Prior to placing the gaseous radwaste treatment system in the charcoal bypass mode, the alarm setpoints on the main plant vent release monitor shall be set to account for the increased percentages of short-lived noble gases. Noble gas percentages shall be based either on actual measured values or on primary coolant design base noble gas concentration percentages adjusted for 30-minute decay. Table 3-15 lists the percentage values for 30-minute decay.

3.5.1 Projection of Doses

The projected doses due to WNP-2 gaseous effluent releases will be determined at least once per 31 days as stated in Requirement for Operability 6.2.2.5. The projected dose when averaged over 31 days is not to exceed 0.3 mrem to any organ in a 31 day period to areas at and beyond the site boundary. Dose projection values will be determined by using a previous 31 day "GasparII Output" (NRC Computer Code) for the site boundary and/or an area beyond the site boundary. Based on operating data, the projected dose should be adjusted accordingly to compensate for those anticipated changes in operations and/or source term values.

3.6 Calculation of Gaseous Effluent Monitor Alarm Setpoints

3.6.1 Introduction

The following procedure is used to ensure that the dose rate in the unrestricted areas due to noble gases in the WNP-2 gaseous effluent do not exceed 500 mrem/yr to the whole body or 3000 mrem/yr to the skin. The initial setpoints determination was calculated using a conservative radionuclide mix obtained from the WNP-2 GALE code. While the plant is operating and sufficient measurable process fission gases are in the effluent, then the actual radionuclide mix will be used to calculate the alarm setpoint.

3.6.2 Setpoint Determination for all Gaseous Release Paths

The setpoints for gaseous effluent are based on instantaneous noble gas dose rates. Sampling and analysis of radioiodines and radionuclides in particulate form will be performed in accordance with Requirement for Operability to ensure compliance with 10 CFR 20 and 10 CFR 50 Appendix I limits. The three release points will be partitioned such that their sum does not exceed 100 percent of the limit. Originally, the setpoints will be set at 40 percent for the Reactor Building, 40 percent for the Turbine Building and 20 percent for the Radwaste Building. These percentages could vary at the plant discretion, should the operational conditions warrant such change. However, the combined releases due to variations in the setpoints will not result in doses which exceed the limit stated in Requirement for Operability. Both skin dose and whole body setpoints will be calculated and the lower limit will be used.

3.6.2.1 Setpoints Calculations Based on Whole Body Dose Limits

The fraction (π_i) of the total gaseous radioactivity in each gaseous effluent release path j for each noble gas radionuclide i will be determined by using the following equation:

$$\pi_{ij} = \frac{M_{ij}}{M_{Tj}} \quad (\text{dimensionless}) \quad (22)$$

where:

M_{ij} = The measured individual concentration of radionuclide i in the gaseous effluent release path j ($\mu\text{Ci/cc}$).

M_{Tj} = The measured total concentration of all noble gases identified in the gaseous effluent release path j ($\mu\text{Ci/cc}$).

Based on Requirement for Operability 6.2.2.1, the maximum acceptable release rate of all noble gases in the gaseous effluent release path j is calculated by using the following equation:

$$Q_{Tj} = \frac{F_j \cdot 500}{X/Q_j \sum_{i=1}^m (K_i)(\pi_{ij})} \quad (\mu\text{Ci}/\text{sec}) \quad (23)$$

where:

- Q_{Tj} = The maximum acceptable release rate ($\mu\text{Ci}/\text{sec}$) of all noble gases in the gaseous effluent release path j ($\mu\text{Ci}/\text{cc}$).
- F_j = Fraction of total dose allocated to release path j.
- 500 = Whole body dose rate limit of 500 mrem/yr as specified in Requirement for Operability 6.2.2.1.a.
- X/Q_j = Maximum normalized diffusion coefficient of effluent release path j at and beyond the site boundary (sec/m^3). Turbine Building and Radwaste Building values are based on average annual ground level values. Main plant vent release values are for mixed mode and may be either short term or average annual value dependent upon type of release.
- K_i = The total whole body dose factor due to gamma emission from noble gas nuclide i (mrem/yr per $\mu\text{Ci}/\text{m}^3$) (as listed in Table B-1 of Regulatory Guide 1.109, Revision 1).
- π_{ij} = As defined in Equation (22).
- m = Total number of radionuclides in the gaseous effluent.
- j = Different release pathways.

The total maximum acceptable concentration (C_{Tj}) of noble gas radionuclides in the gaseous effluent release path j ($\mu\text{Ci}/\text{cc}$) will be calculated by using the following equation:

$$C_{Tj} = \frac{Q_{Tj}}{R_j} \quad (\mu\text{Ci}/\text{cc}) \quad (24)$$

where:

- C_{Tj} = The total allowed concentration of all noble gas radionuclides in the gaseous effluent release path j ($\mu\text{Ci/cc}$).
- Q_{Tj} = The maximum acceptable release rate ($\mu\text{Ci/sec}$) of all noble gases in the gaseous effluent release path j.
- R_j = The effluent release rate (cc/sec) at the point of release.

To determine the maximum acceptable concentration (C_{ij}) of noble gas radionuclide i in the gaseous effluent for each individual noble gas in the gaseous effluent ($\mu\text{Ci/cc}$), the following equation will be used:

$$C_{ij} = \pi_{ij} C_{Tj} \quad (\mu\text{Ci/cc}) \quad (25)$$

where:

π_{ij} and C_{Tj} are as defined in Equations (22) and (24) respectively, the gaseous effluent monitor alarm setpoint will then be calculated as follows:

$$\text{C.R.}j = \sum_{i=1}^m C_{ij} E_{ij} (\text{cpm}) \quad (26)$$

where:

- $\text{C.R.}j$ = Count rate above background (cpm) for gaseous release path j.
- C_{ij} = The maximum acceptable concentration of noble gas nuclide i in the gaseous effluent release path j $\mu\text{Ci/cc}$.
- E_{ij} = Detection efficiency of the gaseous effluent monitor j for noble gas i ($\text{cpm}/\mu\text{Ci/cc}$).

3.6.2.2 Setpoints Calculations Based on Skin Dose Limits

The method for calculating the setpoints to ensure compliance with the skin dose limits specified in Requirement for Operability 6.2.2.1.a is similar to the one described for whole body dose limits (Section 3.6.2.1 of this manual), except Equation (27) will be used instead of Equation (23) for determining maximum acceptable release rate (Q_{Tj}).

$$Q_{Tj} = \frac{F_j \ 3000}{(X/Q_j) \sum_{i=1}^m (L_i + 1.1M_i)(\pi_{ij})} \quad (\mu\text{Ci/sec}) \quad (27)$$

where:

- Q_{Tj} = The maximum acceptable release rate of all noble gases in the gaseous effluent release path j in $\mu\text{Ci/sec}$.
- X/Q_j = The maximum annual normalized diffusion coefficient for release path j at and beyond the site boundary (sec/m^3).
- F_j = Fraction of total allowed dose.
- L_i = The skin dose factor due to beta emission for each identified noble gas radionuclide i in $\text{mrem/yr per } \mu\text{Ci/m}^3$ (L_i values are listed in Table 3-1).
- M_i = The air dose factor due to gamma emissions for each identified noble gas radionuclide, in $\text{mrad/yr per } \mu\text{Ci/m}^3$ (M_i values are listed in Table 3-1).
- 1.1 = A conversion factor to convert dose in mrad to dose equivalent in mrem.
- 3000 = Skin dose rate limit of 3000 mrem/yr as specified in Requirement for Operability 6.2.2.1.

Table 3-1

DOSE FACTORS FOR NOBLE GASES AND DAUGHTERS*

<u>Radionuclide</u>	<u>Total Body</u> Dose Factor $\frac{K_i}{(mrem/yr \text{ per } \mu Ci/m^3)}$	<u>Skin Dose Factor</u> $\frac{L_i}{(mrem/yr \text{ per } \mu Ci/m^3)}$	<u>Gamma Air</u> Dose Factor $\frac{M_i}{(mrad/yr \text{ per } \mu Ci/m^3)}$	<u>Beta Air</u> Dose Factor $\frac{N_i}{(mrad/yr \text{ per } \mu Ci/m^3)}$
Kr-85m	1.17E+03**	1.46E+03	1.23E+03	1.97E+03
Kr-85	1.61E+01	1.34E+03	1.72E+01	1.95E+03
Kr-87	5.92E+03	9.73E+03	6.17E+03	1.03E+04
Kr-88	1.47E+04	2.37E+03	1.52E+04	2.93E+03
Kr-89	1.66E+04	1.01E+04	1.73E+04	1.06E+04
Kr-90	1.56E+04	7.29E+03	1.63E+04	7.83E+03
Xe-131m	9.15E+01	4.76E+02	1.56E+02	1.11E+03
Xe-133m	2.51E+02	9.94E+02	3.27E+02	1.48E+03
Xe-133	2.94E+02	3.06E+02	3.53E+02	1.05E+03
Xe-135m	3.12E+03	7.11E+02	3.36E+03	7.39E+02
Xe-135	1.81E+03	1.86E+03	1.92E+03	2.46E+03
Xe-137	1.42E+03	1.22E+04	1.51E+03	1.27E+04
Xe-138	8.83E+03	4.13E+03	9.21E+03	4.75E+03
Ar-41	8.84E+03	2.69E+03	9.30E+03	3.28E+03

*The listed dose factors are for radionuclides that may be detected in gaseous effluents.

**7.56E-02 = 7.56×10^{-2} .

The values listed above were taken from Table B-1 of NRC Regulatory Guide 1.109, Revision 1. The values were multiplied by 10^6 to convert picocuries⁻¹ to microcuries⁻¹.

Table 3-2

DISTANCES (MILES) TO TYPICAL CONTROLLING LOCATIONS
 AS MEASURED FROM CENTER OF WNP-2 CONTAINMENT BUILDING*

<u>Location</u>	<u>Distance (miles)</u>	<u>Sector</u>	<u>Dose Pathways</u>
Site Boundary	1.2	SE	Air dose measurement
One	4.2	ESE	Ground, vegetables, and inhalation
Two	6.4	SE	Ground, meat, and inhalation
Three	4.5	ESE	Ground, vegetables, and inhalation
Four	4.1	ENE	Ground, vegetables, and inhalation
Five	4.3	NE	Ground and inhalation
Six	7.2	ESE	Ground, Cow milk, and inhalation

*Typical locations and pathways are based on the current Land Use Census (LUC).

Table 3-3
WNP-2 LONG-TERM AVERAGE DISPERSION (X/Q)
AND DEPOSITION (D/Q) VALUES FOR TYPICAL LOCATIONS

Location	Sector	Distance (miles)	Point of Release	X/Q		X/Q		D/Q (m ⁻²)
				No Decay No Depletion (sec/m ³)	2.3 Days Decay No Depletion (sec/m ³)	8.0 Days Decay Depleted (sec/m ³)		
Site Boundary	SE	1.2	Reactor Bldg.	2.7E-07	2.7E-07	2.6E-07	2.0E-09	
			Turbine Bldg.	1.4E-05	1.3E-05	1.2E-05	1.2E-08	
			Radwaste Bldg.	1.4E-05	1.3E-05	1.2E-05	1.2E-08	
One	ESE	4.2	Reactor Bldg.	1.5E-06	1.5E-06	1.2E-06	6.0E-10	
			Turbine Bldg.	1.1E-06	1.0E-06	8.1E-07	6.0E-10	
			Radwaste Bldg.	1.1E-06	1.0E-06	8.1E-07	6.0E-10	
Two	SE	6.4	Reactor Bldg.	3.7E-07	3.5E-07	3.4E-07	3.2E-10	
			Turbine Bldg.	7.2E-07	6.8E-07	5.1E-07	2.6E-10	
			Radwaste Bldg.	7.2E-07	6.8E-07	5.1E-07	2.6E-10	
Three	ESE	4.5	Reactor Bldg.	1.6E-06	1.5E-06	1.3E-06	5.1E-10	
			Turbine Bldg.	1.0E-06	9.8E-07	7.7E-07	5.1E-10	
			Radwaste Bldg.	1.0E-06	9.8E-07	7.7E-07	5.1E-10	
Four	ENE	4.1	Reactor Bldg.	9.8E-07	9.3E-07	7.7E-07	3.8E-10	
			Turbine Bldg.	6.9E-07	6.5E-07	5.2E-07	3.7E-10	
			Radwaste Bldg.	6.9E-07	6.5E-07	5.2E-07	3.7E-10	
Five	NE	4.3	Reactor Bldg.	6.8E-08	6.6E-08	6.6E-08	1.3E-10	
			Turbine Bldg.	6.7E-07	6.3E-07	5.0E-07	3.7E-10	
			Radwaste Bldg.	6.7E-07	6.3E-07	5.0E-07	3.7E-10	
Six	ESE	7.2	Reactor Bldg.	7.9E-07	7.1E-07	5.9E-07	1.9E-10	
			Turbine Bldg.	5.2E-07	4.7E-07	3.6E-07	1.9E-10	
			Radwaste Bldg.	5.2E-07	4.7E-07	3.6E-07	1.9E-10	

Table 3-4

DOSE RATE PARAMETERS
IMPLEMENTATION OF 10 CFR 20, AIRBORNE RELEASES

Nuclide	$\lambda(\text{sec}^{-1})$	<u>Child Dose Factor*</u>		P_i^I
		DFA _i mrem/pCi	DFG _i mrem/hr pCi/m ²	Inhalation mrem/yr $\mu\text{Ci}/\text{m}^3$
H-3	1.8E-09	1.7E-07	0.0	6.3E+02
Na-24	1.3E-05	4.4E-06	2.9E-08	1.6E+04
Cr-51	2.9E-07	4.6E-06	2.6E-10	1.7E+04
Mn-54	2.6E-08	4.3E-04	6.8E-09	1.6E+06
Mn-56	7.5E-05	3.3E-05	1.3E-08	1.2E+05
Fe-55	8.5E-09	3.0E-05	0.0	1.1E+05
Fe-59	1.8E-07	3.4E-04	9.4E-09	1.3E+06
Co-58	1.1E-07	3.0E-04	8.2E-09	1.1E+06
Co-60	4.2E-09	1.9E-03	2.0E-08	7.0E+06
Cu-64	1.5E-05	9.9E-06	1.7E-09	3.7E+04
Zn-65	3.3E-08	2.7E-04	4.6E-09	1.0E+06
Zn-69m	1.4E-05	2.7E-05	3.4E-09	1.0E+05
As-76	7.3E-06	1.9E-05	1.7E-07	7.0E+04
Br-82	5.5E-06	5.7E-06	2.2E-08	2.1E+04
Sr-89	1.5E-07	5.8E-04	6.5E-13	2.2E+06
Sr-90	7.9E-10	1.0E-02	2.6E-12**	3.7E+07
Zr-95	1.2E-07	6.0E-04	5.8E-09	2.2E+06
Nb-95	2.3E-07	1.7E-04	6.0E-09	6.3E+05
Zr-97	1.1E-05	9.5E-05	6.4E-09	3.5E+05
Nb-97	1.6E-04	7.5E-06	5.4E-09	2.8E+04
Mo-99	2.9E-06	3.7E-05	2.2E-09	1.4E+05
Tc-99m	3.2E-05	1.3E-06	1.1E-09	4.8E+03
Ru-106	2.2E-08	3.9E-03	1.8E-09	1.4E+07
Ag-110m	3.2E-08	1.5E-03	2.1E-08	5.6E+06
Sb-124	1.3E-07	8.8E-04	1.5E-08	3.3E+06
Sb-125	7.9E-09	6.3E-04	3.5E-09	2.3E+06
Sb-126	6.5E-07	2.9E-04	1.0E-08	1.1E+06
Sb-127	2.1E-06	6.2E-05	6.6E-09	2.3E+05
Te-127	2.1E-05	1.5E-05	1.1E-11	5.6E+04
Te-131m	6.4E-06	8.3E-05	9.9E-09	3.1E+05
I-131	1.0E-06	4.4E-03	3.4E-09	1.6E+07
I-132	8.4E-05	5.2E-05	2.0E-08	1.9E+05
I-133	9.2E-06	1.0E-03	4.5E-09	3.7E+06
I-135	2.9E-05	2.1E-04	1.4E-08	7.8E+05

Table 3-4

DOSE RATE PARAMETERS
IMPLEMENTATION OF 10 CFR 20, AIRBORNE RELEASES

<u>Nuclide</u>	<u>$\lambda(\text{sec}^{-1})$</u>	<u>Child Dose Factor*</u>		<u>P_1^I</u>
		<u>DFA_i</u> <u>mrem/pCi</u>	<u>DFG_i</u> <u>mrem/hr</u> <u>pCi/m²</u>	<u>Inhalation</u> <u>mrem/yr</u> <u>$\mu\text{Ci}/\text{m}^3$</u>
Cs-134	1.1E-08	2.7E-04	1.4E-08	1.0E+06
Cs-137	7.3E-10	2.5E-04	4.9E-09	9.3E+05
Cs-138	3.6E-04	2.3E-07	2.4E-08	8.5E+02
Ba-140	6.3E-07	4.7E-04	2.4E-09	1.7E+06
La-140	4.8E-06	6.1E-05	1.7E-08	2.3E+05
Ce-141	2.4E-07	1.5E-04	6.2E-10	5.6E+05
Ce-144	2.8E-08	3.2E-03	3.7E-10	1.2E+07
Nd-147	7.2E-07	8.9E-05	1.2E-09	3.3E+05
Hf-179m	3.7E-02	2.0E-05	NO DATA	7.4E+04
Hf-181	1.8E-07	6.0E-05	1.2E-08	2.2E+05
W-185	1.1E-07	1.9E-04	0.0	7.0E+05
Np-239	3.4E-06	1.7E-05	9.5E-10	6.4E+04

* Maximum Organ

**No data is listed for Sr-90 in Table E-6 of Regulatory Guide 1.109, Revision 1. Y-90 values were used for dose conversion factor Sr-90.

Table 3-5a

DOSE PARAMETERS FOR 10 CFR 50 EVALUATIONS, AIRBORNE RELEASES
AGE GROUP: ADULT ORGAN OF REFERENCE: MAXIMUM ORGAN
R(I), INDIVIDUAL PATHWAY DOSE PARAMETERS FOR RADIONUCLIDES OTHER THAN NOBLE GASES

Radionuclide	Inhalation (mrem/yr per $\mu\text{Ci}/\text{M}^3$)	Ground Plane ($\text{M}^2 \cdot \text{mrem}/\text{yr}$ per $\mu\text{Ci}/\text{sec}$)	Cow Milk ($\text{M}^2 \cdot \text{mrem}/\text{yr}$ per $\mu\text{Ci}/\text{sec}$)	Goat Milk ($\text{M}^2 \cdot \text{mrem}/\text{yr}$ per $\mu\text{Ci}/\text{sec}$)	Animal Meat ($\text{M}^2 \cdot \text{mrem}/\text{yr}$ per $\mu\text{Ci}/\text{sec}$)	Vegetables ($\text{M}^2 \cdot \text{mrem}/\text{yr}$ per $\mu\text{Ci}/\text{sec}$)
H 3	7.2E+02	0.0E-01	5.8E+02	1.2E+03	2.4E+02	1.6E+03
NA 24	1.0E+04	1.2E+07	1.2E+06	2.2E+05	7.2E-04	1.1E+05
CR 51	1.4E+04	4.7E+06	3.3E+06	5.9E+05	8.2E+05	2.3E+07
MN 54	1.4E+06	1.4E+09	1.4E+07	2.1E+06	1.5E+07	9.4E+08
MN 56	2.0E+04	9.0E+05	6.2E-02	1.1E-02	0.0E-01	2.0E+02
FE 55	7.2E+04	0.0E-01	1.4E+07	2.2E+06	1.6E+08	1.9E+08
FE 59	1.0E+06	2.7E+08	1.1E+08	2.0E+07	9.8E+08	1.5E+09
CO 58	9.3E+05	3.8E+08	4.7E+07	7.6E+06	1.8E+08	8.0E+08
CO 60	6.0E+06	2.3E+10	1.7E+08	2.5E+07	8.0E+08	2.9E+09
CU 64	4.9E+04	6.1E+05	1.0E+06	1.7E+05	1.1E-05	3.3E+05
ZN 65	8.6E+05	7.5E+08	2.7E+09	4.0E+08	7.0E+08	1.3E+09
ZN 69M	1.4E+05	1.3E+06	1.3E+07	2.4E+06	1.2E-03	1.4E+06
AS 76	1.5E+05	3.8E+06	2.1E+07	3.8E+06	2.9E+01	8.0E+06
BR 82	1.4E+04	2.1E+07	1.9E+07	3.4E+06	7.0E+02	7.7E+05
SR 89	1.4E+06	2.2E+04	6.9E+08	2.0E+09	1.4E+08	1.5E+10
SR 90	2.9E+07	6.7E+06	3.4E+10	8.3E+10	8.9E+09	7.4E+11
ZR 95	1.8E+06	2.5E+08	4.6E+05	7.6E+04	9.2E+08	1.6E+09
NB 95	5.1E+05	1.4E+08	1.3E+08	2.2E+07	3.6E+09	8.4E+08
ZR 97	5.2E+05	3.0E+06	1.4E+04	2.4E+03	6.4E-01	8.8E+06
NB 97	2.4E+03	1.8E+05	1.6E-09	2.9E-10	0.0E-01	8.1E-04
MO 99	2.5E+05	4.0E+06	2.9E+07	5.2E+06	1.2E+05	9.3E+06
TC 99M	4.2E+03	1.8E+05	2.8E+03	5.0E+02	3.6E-18	2.2E+03
RU106	9.4E+06	4.2E+08	7.3E+05	1.1E+05	1.0E+11	1.2E+10
AG110M	4.6E+06	3.5E+09	1.2E+10	1.8E+09	1.4E+09	4.4E+09
SB124	2.5E+06	6.0E+08	3.5E+08	5.8E+07	2.7E+08	4.0E+09
SB125	1.7E+06	2.4E+09	1.3E+08	1.8E+07	1.2E+08	1.4E+09
SB126	7.7E+05	8.4E+07	2.2E+08	4.0E+07	7.6E+07	1.6E+09
SB127	3.0E+05	1.7E+07	5.2E+07	9.3E+06	1.9E+06	1.2E+08
TE127	5.7E+04	3.0E+03	2.6E+04	4.7E+03	8.4E-09	2.0E+05
TE131M	5.6E+05	8.0E+06	8.9E+06	1.6E+06	1.1E+04	2.0E+07
I 131	1.2E+07	8.6E+06	3.4E+10	6.1E+10	1.2E+09	4.4E+10
I 132	1.1E+05	6.2E+05	3.9E+00	6.9E+00	0.0E-01	1.1E+03
I 133	2.2E+06	1.2E+06	2.5E+08	4.5E+08	2.4E+01	1.1E+08
I 135	4.5E+05	1.3E+06	5.5E+05	9.8E+05	1.7E-15	1.4E+06
CS134	8.5E+05	6.9E+09	7.4E+09	2.7E+10	8.6E+08	1.0E+10
CS136	1.5E+05	1.5E+08	5.0E+08	2.2E+09	2.3E+07	4.6E+08
CS137	6.2E+05	1.3E+10	6.0E+09	2.1E+10	7.1E+08	8.6E+09
CS138	6.2E+02	3.6E+05	1.0E-23	4.6E-23	0.0E-00	3.0E-11
BA140	1.3E+06	2.1E+07	2.7E+07	4.8E+06	2.8E+07	7.3E+08
LA140	4.6E+05	1.9E+07	8.4E+04	1.5E+04	7.0E+02	3.3E+07
CE141	3.6E+05	1.4E+07	5.8E+06	1.0E+06	1.7E+07	9.3E+08
CE144	7.8E+06	7.0E+07	6.4E+07	9.6E+06	2.6E+08	1.1E+10
ND147	2.2E+05	8.5E+06	2.5E+05	4.6E+04	1.9E+07	5.1E+08
HF179M	1.6E+05	0.0E-01	0.0E-01	0.0E-01	0.0E-01	0.0E-01
HF181	4.8E+05	2.1E+08	5.5E+05	9.3E+04	1.2E+10	1.8E+09
W 185	4.5E+05	1.8E+04	2.4E+07	3.9E+06	1.9E+07	8.4E+08
NP239	1.2E+05	1.7E+06	3.7E+04	6.7E+03	2.6E+03	1.6E+07

NOTE: The Y-90 ground plane dose factor was used for Sr-90.
The PARTS subroutine of GASPAR II was used to produce this table.

Table 3-5b

DOSE PARAMETERS FOR 10 CFR 50 EVALUATIONS, AIRBORNE RELEASES
AGE GROUP: TEEN ORGAN OF REFERENCE: MAXIMUM ORGAN
R(I), INDIVIDUAL PATHWAY DOSE PARAMETERS FOR RADIONUCLIDES OTHER THAN NOBLE GASES

Radionuclide	Inhalation (mrem/yr per $\mu\text{Ci}/\text{M}^3$)	Ground Plane ($\text{M}^2 \cdot \text{mrem}/\text{yr}$ per $\mu\text{Ci}/\text{sec}$)	Cow Milk ($\text{M}^2 \cdot \text{mrem}/\text{yr}$ per $\mu\text{Ci}/\text{sec}$)	Goat Milk ($\text{M}^2 \cdot \text{mrem}/\text{yr}$ per $\mu\text{Ci}/\text{sec}$)	Animal Meat ($\text{M}^2 \cdot \text{mrem}/\text{yr}$ per $\mu\text{Ci}/\text{sec}$)	Vegetables ($\text{M}^2 \cdot \text{mrem}/\text{yr}$ per $\mu\text{Ci}/\text{sec}$)
H 3	7.3E+02	0.0E-01	7.5E+02	1.5E+03	1.5E+02	1.9E+03
NA 24	1.4E+04	1.2E+07	2.1E+06	3.9E+05	5.8E-04	1.0E+05
CR 51	2.1E+04	4.7E+06	3.9E+06	6.8E+05	4.4E+05	2.5E+07
MN 54	2.0E+06	1.4E+09	1.6E+07	2.3E+06	7.8E+06	9.6E+08
MN 56	5.7E+04	9.0E+05	2.3E-01	4.1E-02	0.0E-00	3.7E+02
FE 55	1.2E+05	0.0E-01	2.4E+07	3.8E+06	1.3E+08	3.0E+08
FE 59	1.5E+06	2.7E+08	1.3E+08	2.5E+07	5.5E+08	1.7E+09
CO 58	1.3E+06	3.8E+08	5.3E+07	8.7E+06	9.4E+07	8.3E+08
CO 60	8.7E+06	2.3E+10	2.1E+08	3.0E+07	4.3E+08	3.1E+09
CU 64	6.1E+04	6.1E+05	1.6E+06	2.7E+05	8.0E-06	2.7E+05
ZN 65	1.2E+06	7.5E+08	4.5E+09	6.7E+08	5.4E+08	2.0E+09
ZN 69M	1.7E+05	1.3E+06	2.1E+07	3.8E+06	9.1E-04	1.1E+06
AS 76	1.5E+05	3.8E+06	2.7E+07	4.9E+06	1.7E+01	5.3E+06
BR 82	1.8E+04	2.1E+07	2.8E+07	5.1E+06	4.9E+02	6.1E+05
SR 89	2.4E+06	2.2E+04	1.3E+09	3.7E+09	1.2E+08	2.4E+10
SR 90	3.3E+07	6.7E+06	5.1E+10	1.3E+11	6.2E+09	1.0E+12
ZR 95	2.7E+06	2.5E+08	5.8E+05	9.5E+04	5.3E+08	1.8E+09
NB 95	7.5E+05	1.4E+08	1.6E+08	2.7E+07	2.0E+09	9.1E+08
ZR 97	6.3E+05	3.0E+06	2.1E+04	3.8E+03	4.6E-01	7.0E+06
NB 97	3.9E+03	1.8E+05	1.9E-08	3.3E-09	0.0E-01	4.8E-03
MO 99	2.7E+05	4.0E+06	5.1E+07	9.2E+06	9.4E+04	1.1E+07
TC 99M	6.1E+03	1.8E+05	5.3E+03	9.5E+02	3.2E-18	2.1E+03
RU106	1.6E+07	4.2E+08	9.9E+05	1.5E+05	6.2E+10	1.5E+10
AG110M	6.8E+06	3.5E+09	1.4E+10	2.1E+09	7.6E+08	4.6E+09
SB124	3.8E+06	6.0E+08	4.5E+08	7.3E+07	1.6E+08	4.6E+09
SB125	2.7E+06	2.4E+09	1.6E+08	2.3E+07	6.8E+07	1.6E+09
SB126	1.2E+06	8.4E+07	2.8E+08	5.1E+07	4.5E+07	1.8E+09
SB127	3.2E+05	1.7E+07	6.9E+07	1.2E+07	1.2E+06	1.2E+08
TE127	8.1E+04	3.0E+03	4.8E+04	8.6E+03	7.0E-09	1.8E+05
TE131M	6.2E+05	8.0E+06	1.3E+07	2.3E+06	7.4E+03	1.5E+07
I 131	1.5E+07	8.6E+06	5.4E+10	9.7E+10	9.0E+08	6.1E+10
I 132	1.5E+05	6.2E+05	6.4E+00	1.2E+01	0.0E-00	9.3E+02
I 133	2.9E+06	1.2E+06	4.2E+08	7.5E+08	1.8E+01	9.6E+07
I 135	6.2E+05	1.3E+06	9.3E+05	1.7E+06	1.3E-15	1.2E+06
CS134	1.1E+06	6.9E+09	1.3E+10	4.6E+10	6.8E+08	1.6E+10
CS136	1.9E+05	1.5E+08	8.4E+08	3.8E+09	1.8E+07	7.0E+08
CS137	8.5E+05	1.3E+10	1.1E+10	3.8E+10	5.7E+08	1.4E+10
CS138	8.6E+02	3.6E+05	1.8E-23	8.1E-23	0.0E-00	2.7E-11
BA140	2.0E+06	2.1E+07	3.6E+07	6.4E+06	1.8E+07	8.8E+08
LA140	4.9E+05	1.9E+07	1.1E+05	2.1E+04	4.4E+02	2.4E+07
CE141	6.1E+05	1.4E+07	7.9E+06	1.4E+06	1.0E+07	1.1E+09
CE144	1.3E+07	7.0E+07	8.8E+07	1.3E+07	1.6E+08	1.3E+10
ND147	3.7E+05	8.5E+06	3.5E+05	6.2E+04	1.2E+07	6.1E+08
HF179M	7.1E+04	0.0E-01	0.0E-01	0.0E-01	0.0E-01	0.0E-01
HF181	4.8E+05	2.1E+08	7.1E+05	1.2E+05	7.0E+09	2.1E+09
W 185	7.7E+05	1.8E+04	3.3E+07	5.4E+06	1.2E+07	1.0E+09
NP239	1.3E+05	1.7E+06	5.3E+04	9.6E+03	1.7E+03	1.4E+07

NOTE: The Y-90 ground plane dose factor was used for Sr-90.
The PARTS subroutine of GASPAR II was used to produce this table.

Table 3-5c

DOSE PARAMETERS FOR 10 CFR 50 EVALUATIONS, AIRBORNE RELEASES
AGE GROUP: CHILD ORGAN OF REFERENCE: MAXIMUM ORGAN
R(I), INDIVIDUAL PATHWAY DOSE PARAMETERS FOR RADIONUCLIDES OTHER THAN NOBLE GASES

Radionuclide	Inhalation (mrem/yr per $\mu\text{Ci}/\text{M}^3$)	Ground Plane ($\text{M}^2 \cdot \text{mrem}/\text{yr}$ per $\mu\text{Ci}/\text{sec}$)	Cow Milk ($\text{M}^2 \cdot \text{mrem}/\text{yr}$ per $\mu\text{Ci}/\text{sec}$)	Goat Milk ($\text{M}^2 \cdot \text{mrem}/\text{yr}$ per $\mu\text{Ci}/\text{sec}$)	Animal Meat ($\text{M}^2 \cdot \text{mrem}/\text{yr}$ per $\mu\text{Ci}/\text{sec}$)	Vegetables ($\text{M}^2 \cdot \text{mrem}/\text{yr}$ per $\mu\text{Ci}/\text{sec}$)
H 3	6.4E+02	0.0E-01	1.2E+03	2.4E+03	1.8E+02	2.9E+03
NA 24	1.6E+04	1.2E+07	4.5E+06	8.0E+05	9.2E-04	1.6E+05
CR 51	1.7E+04	4.7E+06	2.5E+06	4.4E+05	2.2E+05	1.6E+07
MN 54	1.6E+06	1.4E+09	1.1E+07	1.7E+06	4.3E+06	6.9E+08
MN 56	1.2E+05	9.0E+05	8.8E-01	1.6E-01	0.0E-00	1.1E+03
FE 55	1.1E+05	0.0E-01	6.1E+07	9.6E+06	2.5E+08	7.6E+08
FE 59	1.3E+06	2.7E+08	9.5E+07	1.7E+07	3.0E+08	1.2E+09
CO 58	1.1E+06	3.8E+08	3.4E+07	5.6E+06	4.7E+07	5.3E+08
CO 60	7.1E+06	2.3E+10	1.4E+08	2.0E+07	2.2E+08	2.1E+09
CU 64	3.7E+04	6.1E+05	1.7E+06	2.9E+05	6.5E-06	2.2E+05
ZN 65	1.0E+06	7.5E+08	6.8E+09	1.0E+09	6.2E+08	3.0E+09
ZN 69M	1.0E+05	1.3E+06	2.2E+07	4.0E+06	7.2E-04	9.0E+05
AS 76	7.0E+04	3.8E+06	2.2E+07	4.0E+06	1.1E+01	3.3E+06
BR 82	2.1E+04	2.1E+07	5.8E+07	1.0E+07	7.6E+02	9.5E+05
SR 89	2.2E+06	2.2E+04	3.1E+09	9.2E+09	2.3E+08	6.0E+10
SR 90	3.8E+07	6.7E+06	1.0E+11	2.6E+11	9.8E+09	2.1E+12
ZR 95	2.2E+06	2.5E+08	4.2E+05	7.0E+04	3.0E+08	1.3E+09
NB 95	6.1E+05	1.4E+08	1.1E+08	1.8E+07	1.0E+09	6.2E+08
ZR 97	3.5E+05	3.0E+06	2.1E+04	3.8E+03	3.5E-01	5.2E+06
NB 97	2.8E+04	1.8E+05	4.2E-07	7.6E-08	0.0E-01	8.2E-02
MO 99	1.3E+05	4.0E+06	8.7E+07	1.6E+07	1.2E+05	1.6E+07
TC 99M	4.8E+03	1.8E+05	7.4E+03	1.3E+03	3.4E-18	2.2E+03
RU106	1.4E+07	4.2E+08	7.9E+05	1.2E+05	3.8E+10	1.2E+10
AG110M	5.5E+06	3.5E+09	9.4E+09	1.4E+09	3.8E+08	3.0E+09
SB124	3.2E+06	6.0E+08	3.3E+08	5.4E+07	8.8E+07	3.3E+09
SB125	2.3E+06	2.4E+09	1.2E+08	1.7E+07	3.8E+07	1.2E+09
SB126	1.1E+06	8.4E+07	2.2E+08	4.0E+07	2.7E+07	1.4E+09
SB127	2.3E+05	1.7E+07	5.5E+07	1.0E+07	7.2E+05	9.2E+07
TE127	5.6E+04	3.0E+03	5.9E+04	1.1E+04	6.7E-09	1.7E+05
TE131M	3.1E+05	8.0E+06	1.1E+07	2.1E+06	5.0E+03	9.9E+06
I 131	1.6E+07	8.6E+06	1.1E+11	1.9E+11	1.4E+09	1.2E+11
I 132	1.9E+05	6.2E+05	1.5E+01	2.7E+01	0.0E-00	1.6E+03
I 133	3.8E+06	1.2E+06	9.9E+08	1.8E+09	3.3E+01	1.7E+08
I 135	7.9E+05	1.3E+06	2.1E+06	3.8E+06	2.3E-15	2.1E+06
CS134	1.0E+06	6.9E+09	2.0E+10	7.5E+10	8.3E+08	2.6E+10
CS136	1.7E+05	1.5E+08	1.3E+09	6.0E+09	2.1E+07	1.1E+09
CS137	9.1E+05	1.3E+10	1.9E+10	6.8E+10	7.9E+08	2.5E+10
CS138	8.4E+02	3.6E+05	3.2E-23	1.4E-22	0.0E-00	3.6E-11
BA140	1.7E+06	2.1E+07	5.6E+07	1.0E+07	2.1E+07	1.4E+09
LA140	2.3E+05	1.9E+07	9.5E+04	1.7E+04	2.8E+02	1.6E+07
CE141	5.4E+05	1.4E+07	6.3E+06	1.1E+06	6.4E+06	9.0E+08
CE144	1.2E+07	7.0E+07	7.0E+07	1.1E+07	1.0E+08	1.1E+10
ND147	3.3E+05	8.5E+06	2.8E+05	5.0E+04	7.4E+06	4.8E+08
HF179M	7.4E+04	0.0E-01	0.0E-01	0.0E-01	0.0E-01	0.0E-01
HF181	2.2E+05	2.1E+08	5.9E+05	9.9E+04	4.4E+09	1.8E+09
W 185	6.9E+05	1.8E+04	2.7E+07	4.3E+06	7.3E+06	8.3E+08
NP239	6.4E+04	1.7E+06	4.6E+04	8.3E+03	1.1E+03	1.0E+07

NOTE: The Y-90 ground plane dose factor was used for Sr-90.
The PARTS subroutine of GASPARI II was used to produce this table.

Table 3-5d

DOSE PARAMETERS FOR 10 CFR 50 EVALUATIONS, AIRBORNE RELEASES
AGE GROUP: INFANT ORGAN OF REFERENCE: MAXIMUM ORGAN
R(I), INDIVIDUAL PATHWAY DOSE PARAMETERS FOR RADIONUCLIDES OTHER THAN NOBLE GASES

Radionuclide	Inhalation (mrem/yr per $\mu\text{Ci}/\text{M}^3$)	Ground Plane ($\text{M}^2 \cdot \text{mrem}/\text{yr}$ per $\mu\text{Ci}/\text{sec}$)	Cow Milk ($\text{M}^2 \cdot \text{mrem}/\text{yr}$ per $\mu\text{Ci}/\text{sec}$)	Goat Milk ($\text{M}^2 \cdot \text{mrem}/\text{yr}$ per $\mu\text{Ci}/\text{sec}$)	Animal Meat ($\text{M}^2 \cdot \text{mrem}/\text{yr}$ per $\mu\text{Ci}/\text{sec}$)	Vegetables ($\text{M}^2 \cdot \text{mrem}/\text{yr}$ per $\mu\text{Ci}/\text{sec}$)
H 3	3.7E+02	0.0E-01	1.8E+03	3.7E+03	0.0E-01	0.0E-01
NA 24	1.1E+04	1.2E+07	7.8E+06	1.4E+06	0.0E-01	0.0E-01
CR 51	1.3E+04	4.7E+06	2.2E+06	3.8E+05	0.0E-01	0.0E-01
MN 54	1.0E+06	1.4E+09	2.1E+07	3.1E+06	0.0E-01	0.0E-01
MN 56	7.2E+04	9.0E+05	1.3E+00	2.4E-01	0.0E-01	0.0E-01
FE 55	8.7E+04	0.0E-01	7.4E+07	1.2E+07	0.0E-01	0.0E-01
FE 59	1.0E+06	2.7E+08	1.8E+08	3.4E+07	0.0E-01	0.0E-01
CO 58	7.8E+05	3.8E+08	2.9E+07	4.8E+06	0.0E-01	0.0E-01
CO 60	4.5E+06	2.3E+10	1.2E+08	1.7E+07	0.0E-01	0.0E-01
CU 64	1.5E+04	6.1E+05	1.9E+06	3.2E+05	0.0E-01	0.0E-01
ZN 65	6.5E+05	7.5E+08	1.2E+10	1.7E+09	0.0E-01	0.0E-01
ZN 69M	4.1E+04	1.3E+06	2.4E+07	4.3E+06	0.0E-01	0.0E-01
AS 76	2.7E+04	3.8E+06	2.2E+07	4.0E+06	0.0E-01	0.0E-01
BR 82	1.3E+04	2.1E+07	9.8E+07	1.8E+07	0.0E-01	0.0E-01
SR 89	2.0E+06	2.2E+04	6.0E+09	1.8E+10	0.0E-01	0.0E-01
SR 90	1.6E+07	6.7E+06	1.2E+11	2.9E+11	0.0E-01	0.0E-01
ZR 95	1.8E+06	2.5E+08	4.0E+05	6.5E+04	0.0E-01	0.0E-01
NB 95	4.8E+05	1.4E+08	9.6E+07	1.7E+07	0.0E-01	0.0E-01
ZR 97	1.4E+05	3.0E+06	2.2E+04	4.0E+03	0.0E-01	0.0E-01
NB 97	2.7E+04	1.8E+05	1.1E-06	1.9E-07	0.0E-01	0.0E-01
MO 99	1.3E+05	4.0E+06	1.6E+08	2.8E+07	0.0E-01	0.0E-01
TC 99M	2.0E+03	1.8E+05	8.2E+03	1.5E+03	0.0E-01	0.0E-01
RU106	1.2E+07	4.2E+08	8.0E+05	1.2E+05	0.0E-01	0.0E-01
AG110M	3.7E+06	3.5E+09	8.2E+09	1.2E+09	0.0E-01	0.0E-01
SB124	2.6E+06	6.0E+08	3.1E+08	5.1E+07	0.0E-01	0.0E-01
SB125	1.6E+06	2.4E+09	1.1E+08	1.6E+07	0.0E-01	0.0E-01
SB126	9.6E+05	8.4E+07	2.1E+08	3.7E+07	0.0E-01	0.0E-01
SB127	2.2E+05	1.7E+07	5.5E+07	9.9E+06	0.0E-01	0.0E-01
TE127	2.4E+04	3.0E+03	6.8E+04	1.2E+04	0.0E-01	0.0E-01
TE131M	2.0E+05	8.0E+06	1.2E+07	2.1E+06	0.0E-01	0.0E-01
I 131	1.5E+07	8.6E+06	2.6E+11	4.7E+11	0.0E-01	0.0E-01
I 132	1.7E+05	6.2E+05	3.4E+01	6.1E+01	0.0E-01	0.0E-01
I 133	3.6E+06	1.2E+06	2.4E+09	4.3E+09	0.0E-01	0.0E-01
I 135	7.0E+05	1.3E+06	4.9E+06	8.9E+06	0.0E-01	0.0E-01
CS134	7.0E+05	6.9E+09	3.7E+10	1.4E+11	0.0E-01	0.0E-01
CS136	1.3E+05	1.5E+08	2.8E+09	1.2E+10	0.0E-01	0.0E-01
CS137	6.1E+05	1.3E+10	3.6E+10	1.3E+11	0.0E-01	0.0E-01
CS138	8.8E+02	3.6E+05	1.2E-22	5.6E-22	0.0E-01	0.0E-01
BA140	1.6E+06	2.1E+07	1.2E+08	2.1E+07	0.0E-01	0.0E-01
LA140	1.7E+05	1.9E+07	9.4E+04	1.7E+04	0.0E-01	0.0E-01
CE141	5.2E+05	1.4E+07	6.4E+06	1.1E+06	0.0E-01	0.0E-01
CE144	9.8E+06	7.0E+07	7.1E+07	1.1E+07	0.0E-01	0.0E-01
ND147	3.2E+05	8.5E+06	2.8E+05	5.0E+04	0.0E-01	0.0E-01
HF179M	2.8E+04	0.0E-01	0.0E-01	0.0E-01	0.0E-01	0.0E-01
HF181	8.4E+04	2.1E+08	5.9E+05	9.9E+04	0.0E-01	0.0E-01
W 185	6.3E+05	1.8E+04	2.7E+07	4.4E+06	0.0E-01	0.0E-01
NP239	6.0E+04	1.7E+06	4.7E+04	8.5E+03	0.0E-01	0.0E-01

NOTE: The Y-90 ground plane dose factor was used for Sr-90.
The PARTS subroutine of GASPAR II was used to produce this table.

Table 3-6

INPUT PARAMETERS FOR CALCULATING R_i^c

<u>Parameter</u>	<u>Value</u>	<u>Table*</u>
r (dimensionless)	1.0 for radioiodine 0.2 for particulates	E-15 E-15
F_m (days/liter)	Each stable element	E-1
U_{sp} (liters/yr) --Infant	330	E-5
--Child	330	E-5
--Teen	400	E-5
--Adult	310	E-5
$(DFL_i)_a$ (mrem/pCi)	Each radionuclide	E-11 to E-14
Y_p (kg/m ²)	0.7	E-15
Y_s (kg/m ²)	2.0	E-15
t_f (seconds)	1.73×10^5 (2 days)	E-15
t_h (seconds)	7.78×10^6 (90 days)	E-15
Q_F (kg/day)	50 for cow 6 for goat	E-3 E-3
f_s (dimensionless)	1.0	NUREG-0133
f_p (dimensionless)	0.5 for cow 0.75 for goat	Site specific Site specific

*Of Regulatory Guide 1.109, Revision 1 unless stated otherwise.

Table 3-7

INPUT PARAMETERS FOR CALCULATING R_i^M		
<u>Parameter</u>	<u>Value</u>	<u>Table*</u>
r (dimensionless)	1.0 for radioiodine	E-15
	0.2 for particulates	E-15
F_f (days/kg)	Each stable element	E-1
U_{ap} (kg/yr)	--Infant	0
	--Child	41
	--Teen	65
	--Adult	110
$(DFL_i)_a$ (mrem/pCi)	Each radionuclide	E-11 to E-14
Y_p (kg/m ²)	0.7	E-15
Y_s (kg/m ²)	2.0	E-15
t_f (seconds)	1.73×10^6 (20 days)	E-15
t_h (seconds)	7.78×10^6 (90 days)	E-15
Q_F (kg/day)	50	E-3

*Of Regulatory Guide 1.109, Revision 1.

Table 3-8
INPUT PARAMETERS FOR CALCULATING R_i^V

<u>Parameter</u>	<u>Value</u>	<u>Table*</u>
r (dimensionless)	1.0 for radioiodine 0.2 for particulates	E-1 E-1
$(DFL_i)_a$ (mrem/pCi)	Each radionuclide	E-11 to E-14
U_a^L (kg/yr) --Infant	0	E-5
--Child	26	E-5
--Teen	42	E-5
--Adult	64	E-5
U_a^S (kg/yr) --Infant	0	E-5
--Child	520	E-5
--Teen	630	E-5
--Adult	520	E-5
f_L (dimensionless)	0.42	Ref 2**
f_g (dimensionless)	0.76	E-15
t_L (seconds)	8.6×10^4 (1 day)	E-15
t_h (seconds)	5.18×10^6 (60 days)	E-15
Y_v (kg/m ²)	2.0	E-15

*Of Regulatory Guide 1.109, Revision 1.

**Refer to Table 3-14.

Table 3-9

INPUT PARAMETERS NEEDED FOR CALCULATING DOSE SUMMARIES TO
THE MAXIMUM INDIVIDUAL AND THE POPULATION WITHIN 50 MILES FROM
WNP-2 GASEOUS EFFLUENT

<u>Input Parameter</u>	<u>Value</u>	<u>Reference*</u>
Distance to Maine (miles)	3000	Ref 1
Fraction of year leafy vegetables are grown	0.42	Ref 2
Fraction of year cows are on pasture	0.5	Ref 2
Fraction of crop from garden	0.76	Ref 3
Fraction of daily intake of cows derived from pasture while on pasture	1.0	Ref 2
Annual average relative humidity (%)	53.8	Ref 4
Annual average temperature (F°)	53.0	Ref 5
Fraction of year goats are on pasture	0.75	Ref 2
Fraction of daily intake of goats derived from pasture while on pasture	1.0	Ref 2
Fraction of year beef cattle are on pasture	0.5	Ref 2
Fraction of daily intake of beef cattle derived from pasture while on pasture	1.0	Ref 2
Population within 50 miles of plant by direction and radii interval in miles.	252,356	Ref 6
Annual 50-mile milk production (liters/yr)	2.8E+08	Refs 7 & 9
Annual 50-mile meat production (kg/yr)	2.3E+07	Refs 7 & 9
Annual 50-mile vegetable production (kg/yr)	3.5E+09	Refs 7 & 9
Source terms		Ref 8

Table 3-9 (contd.)

<u>Input Parameter</u>	<u>Value</u>	<u>Reference*</u>
X/Q values by sector for each distance (recirculation, no decay) (sec/m ³)	See Tables 3-10 and 3-11	Ref 10
X/Q values by sector for each distance (recirculation, 2.26 days decay, undepleted) (sec/m ³)	See Tables 3-10 and 3-11	Ref 10
X/Q values by sector for each distance (recirculation, 8.0 days decay, depleted) (sec/m ³)	See Tables 3-10 and 3-11	Ref 10
D/Q values by sector for each distance (1/m ²)	See Tables 3-10 and 3-11	Ref 10

*References are listed in Table 3-14.

TABLE 3-10

REACTOR BUILDING STACK X/Q AND D/Q VALUES

A) NO DECAY, UNDEPLETED
CHI/Q (SEC/METER CUBED) FOR EACH SEGMENT

DIRECTION FROM SITE	SEGMENT BOUNDARIES IN MILES FROM THE SITE									
	0-1	1-2	2-3	3-4	4-5	5-10	10-20	20-30	30-40	40-50
S	3.899E-07	1.486E-07	6.171E-08	3.982E-08	3.093E-08	2.000E-08	2.118E-07	1.769E-07	1.196E-07	8.944E-08
SSW	2.557E-07	9.471E-08	3.914E-08	2.553E-08	2.000E-08	1.411E-08	1.702E-07	1.431E-07	9.698E-08	7.264E-08
SW	1.635E-07	6.378E-08	3.299E-08	2.517E-08	1.999E-08	3.647E-08	1.045E-07	7.704E-08	5.209E-08	3.894E-08
WSW	6.676E-08	2.927E-08	1.506E-08	1.122E-08	8.872E-09	1.668E-08	5.532E-08	4.156E-08	2.808E-08	2.098E-08
W	6.588E-08	2.996E-08	1.509E-08	1.090E-08	8.368E-09	4.928E-09	2.837E-08	2.330E-08	1.569E-08	1.170E-08
WNW	1.279E-07	5.746E-08	3.018E-08	2.258E-08	1.781E-08	1.324E-08	5.160E-08	4.103E-08	2.750E-08	2.044E-08
NW	2.294E-07	8.625E-08	3.624E-08	2.423E-08	1.934E-08	1.543E-08	9.519E-08	7.785E-08	5.228E-08	3.891E-08
NNW	5.137E-07	1.770E-07	6.982E-08	4.507E-08	4.224E-08	2.976E-08	1.801E-07	1.479E-07	9.945E-08	7.407E-08
N	6.024E-07	2.016E-07	8.063E-08	5.264E-08	4.120E-08	2.146E-07	2.652E-07	1.430E-07	9.579E-08	7.115E-08
NNE	4.988E-07	1.690E-07	6.861E-08	4.526E-08	4.339E-08	2.904E-07	1.966E-07	1.057E-07	7.066E-08	5.243E-08
NE	3.347E-07	1.195E-07	4.965E-08	4.175E-08	1.400E-07	3.198E-07	1.723E-07	9.247E-08	6.174E-08	4.576E-08
ENE	4.184E-07	3.067E-07	4.347E-07	9.267E-07	8.436E-07	4.052E-07	1.641E-07	8.817E-08	5.893E-08	4.371E-08
E	4.207E-07	3.460E-07	4.968E-07	1.027E-06	8.714E-07	4.159E-07	1.669E-07	8.906E-08	5.928E-08	4.385E-08
ESE	6.224E-07	5.205E-07	7.813E-07	1.572E-06	1.364E-06	5.365E-07	2.045E-07	1.403E-07	9.350E-08	6.922E-08
SE	5.045E-07	2.156E-07	1.174E-07	3.944E-07	6.347E-07	3.083E-07	2.738E-07	1.923E-07	1.289E-07	9.576E-08
SSE	4.591E-07	1.855E-07	7.985E-08	5.319E-08	4.237E-08	3.085E-08	2.635E-07	2.188E-07	1.475E-07	1.100E-07

TABLE 3-10 (CONTD)

B) 2.260 DAY DECAY, UNDEPLETED
CHI/Q (SEC/METER CUBED) FOR EACH SEGMENT

DIRECTION FROM SITE	SEGMENT BOUNDARIES IN MILES FROM THE SITE									
	5-1	1-2	2-3	3-4	4-5	5-10	10-20	20-30	30-40	40-50
S	3.887E-07	1.477E-07	6.094E-08	3.904E-08	3.008E-08	1.898E-08	1.813E-07	1.424E-07	8.918E-08	6.201E-08
SSW	2.550E-07	9.411E-08	3.866E-08	2.504E-08	1.947E-08	1.341E-08	1.493E-07	1.190E-07	7.530E-08	5.275E-08
SW	1.630E-07	6.338E-08	3.255E-08	2.463E-08	1.939E-08	3.438E-08	9.132E-08	6.300E-08	3.969E-08	2.776E-08
WSW	6.657E-08	2.909E-08	1.484E-08	1.093E-08	8.533E-09	1.521E-08	4.618E-08	3.210E-08	1.995E-08	1.381E-08
W	6.563E-08	2.972E-08	1.488E-08	1.069E-08	8.157E-09	4.721E-09	2.319E-08	1.757E-08	1.077E-08	7.365E-09
WNW	1.275E-07	5.702E-08	2.970E-08	2.201E-08	1.717E-08	1.226E-08	4.063E-08	2.933E-08	1.765E-08	1.194E-08
NW	2.287E-07	8.575E-08	3.584E-08	2.381E-08	1.888E-08	1.470E-08	8.026E-08	6.139E-08	3.811E-08	2.642E-08
NNW	5.125E-07	1.760E-07	6.913E-08	4.439E-08	4.130E-08	2.853E-08	1.614E-07	1.269E-07	8.077E-08	5.711E-08
N	6.011E-07	2.006E-07	7.988E-08	5.189E-08	4.040E-08	2.000E-07	2.381E-07	1.202E-07	7.574E-08	5.313E-08
NNE	4.978E-07	1.682E-07	6.795E-08	4.456E-08	4.236E-08	2.707E-07	1.714E-07	8.475E-08	5.256E-08	3.639E-08
NE	3.339E-07	1.188E-07	4.909E-08	4.089E-08	1.348E-07	2.908E-07	1.447E-07	7.008E-08	4.277E-08	2.924E-08
ENE	4.172E-07	3.040E-07	4.272E-07	8.948E-07	7.996E-07	3.720E-07	1.390E-07	6.706E-08	4.134E-08	2.827E-08
E	4.194E-07	3.430E-07	4.885E-07	9.909E-07	8.315E-07	3.861E-07	1.445E-07	7.067E-08	4.346E-08	2.986E-08
ESE	6.207E-07	5.158E-07	7.670E-07	1.523E-06	1.306E-06	5.046E-07	1.776E-07	1.132E-07	7.012E-08	4.846E-08
SE	5.030E-07	2.142E-07	1.159E-07	3.850E-07	6.171E-07	2.946E-07	2.383E-07	1.554E-07	9.668E-08	6.701E-08
SSE	4.577E-07	1.843E-07	7.887E-08	5.214E-08	4.117E-08	2.911E-08	2.219E-07	1.724E-07	1.072E-07	7.416E-08

TABLE 3-10 (CONTD)

C) 8,000 DAY DECAY, UNDEPLETED
CHI/Q (SEC/METER CUBED) FOR EACH SEGMENT

DIRECTION FROM SITE	SEGMENT BOUNDARIES IN MILES FROM THE SITE									
	5-1	1-2	2-3	3-4	4-5	5-10	10-20	20-30	30-40	40-50
S	3.793E-07	1.434E-07	5.872E-08	3.765E-08	2.919E-08	1.879E-08	1.925E-07	1.497E-07	9.326E-08	6.496E-08
SSW	2.479E-07	9.089E-08	3.705E-08	2.403E-08	1.880E-08	1.325E-08	1.561E-07	1.226E-07	7.691E-08	5.388E-08
SW	1.572E-07	6.070E-08	3.115E-08	2.387E-08	1.896E-08	3.473E-08	9.189E-08	6.223E-08	3.871E-08	2.694E-08
WSW	6.375E-08	2.776E-08	1.416E-08	1.057E-08	8.356E-09	1.572E-08	4.792E-08	3.295E-08	2.035E-08	1.407E-08
W	6.471E-08	2.914E-08	1.449E-08	1.047E-08	8.037E-09	4.713E-09	2.534E-08	1.922E-08	1.182E-08	8.138E-09
WNW	1.255E-07	5.587E-08	2.901E-08	2.171E-08	1.709E-08	1.261E-08	4.452E-08	3.233E-08	1.960E-08	1.335E-08
NW	2.228E-07	8.309E-08	3.451E-08	2.300E-08	1.837E-08	1.471E-08	8.579E-08	6.505E-08	4.009E-08	2.769E-08
NNW	4.947E-07	1.686E-07	6.558E-08	4.219E-08	3.996E-08	2.820E-08	1.654E-07	1.272E-07	7.938E-08	5.547E-08
N	5.785E-07	1.917E-07	7.566E-08	4.927E-08	3.863E-08	2.032E-07	2.372E-07	1.154E-07	7.127E-08	4.939E-08
NNE	4.769E-07	1.602E-07	6.423E-08	4.232E-08	4.105E-08	2.728E-07	1.696E-07	8.150E-08	4.985E-08	3.425E-08
NE	3.220E-07	1.141E-07	4.688E-08	3.977E-08	1.366E-07	2.947E-07	1.433E-07	6.805E-08	4.121E-08	2.806E-08
ENE	4.056E-07	2.988E-07	3.849E-07	7.340E-07	6.588E-07	2.951E-07	1.033E-07	4.759E-08	2.806E-08	1.864E-08
E	4.072E-07	3.375E-07	4.406E-07	8.152E-07	6.738E-07	3.000E-07	1.042E-07	4.785E-08	2.822E-08	1.877E-08
ESE	5.997E-07	5.068E-07	6.926E-07	1.240E-06	1.053E-06	3.916E-07	1.247E-07	7.545E-08	4.463E-08	2.978E-08
SE	4.883E-07	2.075E-07	1.122E-07	3.874E-07	6.185E-07	2.852E-07	2.217E-07	1.413E-07	8.648E-08	5.940E-08
SSE	4.476E-07	1.796E-07	7.640E-08	5.064E-08	4.029E-08	2.929E-08	2.179E-07	1.669E-07	1.027E-07	7.085E-08

TABLE 3-10 (CONTD)
RELATIVE DEPOSITION PER UNIT AREA (M**2) BY DOWNWIND SECTORS

D) REACTOR BUILDING D/Q

DIRECTION FROM SITE	SEGMENT BOUNDARIES IN MILES									
	.5-1	1-2	2-3	3-4	4-5	5-10	10-20	20-30	30-40	40-50
S	4.044E-09	1.146E-09	3.717E-10	1.874E-10	1.127E-10	4.635E-11	3.868E-11	2.283E-11	1.219E-11	7.548E-12
SSW	2.643E-09	7.296E-10	2.324E-10	1.165E-10	7.000E-11	2.916E-11	2.663E-11	1.596E-11	8.526E-12	5.278E-12
SW	1.429E-09	4.068E-10	1.407E-10	6.799E-11	4.016E-11	3.192E-11	2.386E-11	9.555E-12	5.104E-12	3.160E-12
WSW	4.407E-10	1.347E-10	4.908E-11	2.400E-11	1.423E-11	1.224E-11	9.617E-12	3.865E-12	2.064E-12	1.278E-12
W	5.587E-10	1.780E-10	6.665E-11	3.253E-11	1.929E-11	7.707E-12	6.116E-12	3.617E-12	1.932E-12	1.196E-12
WNW	1.110E-09	3.459E-10	1.262E-10	6.186E-11	3.674E-11	2.357E-11	1.640E-11	6.963E-12	3.719E-12	2.302E-12
NW	2.199E-09	6.289E-10	2.051E-10	1.036E-10	6.242E-11	2.625E-11	2.528E-11	1.520E-11	8.117E-12	5.025E-12
NNW	5.161E-09	1.411E-09	4.463E-10	2.231E-10	1.382E-10	5.828E-11	5.329E-11	3.186E-11	1.702E-11	1.053E-11
N	7.312E-09	1.932E-09	6.001E-10	2.970E-10	1.774E-10	1.307E-10	8.654E-11	3.430E-11	1.832E-11	1.134E-11
NNE	6.688E-09	1.751E-09	5.437E-10	2.675E-10	1.637E-10	1.566E-10	6.754E-11	2.677E-11	4.430E-11	8.851E-12
NE	4.654E-09	1.223E-09	3.808E-10	1.931E-10	2.225E-10	1.592E-10	4.683E-11	1.873E-11	1.000E-11	6.191E-12
ENE	4.842E-09	1.277E-09	6.137E-10	5.265E-10	3.056E-10	1.189E-10	3.440E-11	1.364E-11	7.286E-12	4.511E-12
E	4.004E-09	1.121E-09	6.044E-10	5.617E-10	3.268E-10	1.248E-10	3.590E-11	1.441E-11	7.695E-12	4.763E-12
ESE	6.270E-09	1.764E-09	9.704E-10	9.016E-10	5.207E-10	2.008E-10	5.788E-11	2.316E-11	1.237E-11	7.659E-12
SE	5.027E-09	1.477E-09	5.218E-10	5.481E-10	6.894E-10	2.662E-10	7.839E-11	3.142E-11	1.678E-11	1.039E-11
SSE	4.426E-09	1.321E-09	4.452E-10	2.267E-10	1.366E-10	5.692E-11	4.873E-11	2.896E-11	1.547E-11	9.573E-12

TABLE 3-11

TURBINE OR RADWASTE BUILDING X/Q AND D/Q VALUES

A) NO DECAY, UNDEPLETED
CHI/Q (SEC/METER CUBED) FOR EACH SEGMENT

DIRECTION FROM SITE	SEGMENT BOUNDARIES IN MILES FROM THE SITE									
	5-1	1-2	2-3	3-4	4-5	5-10	10-20	20-30	30-40	40-50
S	2.782E-05	7.806E-06	2.832E-06	1.567E-06	1.037E-06	5.081E-07	2.113E-07	1.153E-07	7.771E-08	5.794E-08
SSW	2.117E-05	6.000E-06	2.195E-06	1.220E-06	8.099E-07	3.989E-07	1.671E-07	9.172E-08	6.199E-08	4.631E-08
SW	1.211E-05	3.404E-06	1.236E-06	6.834E-07	4.521E-07	2.214E-07	9.199E-08	5.019E-08	3.381E-08	2.520E-08
WSW	6.468E-06	1.831E-06	6.680E-07	3.702E-07	2.451E-07	1.202E-07	5.001E-08	2.729E-08	1.837E-08	1.369E-08
W	4.034E-06	1.113E-06	3.982E-07	2.186E-07	1.439E-07	6.994E-08	2.873E-08	1.555E-08	1.043E-08	7.751E-09
WNW	7.812E-06	2.127E-06	7.518E-07	4.096E-07	2.682E-07	1.292E-07	5.239E-08	2.809E-08	1.873E-08	1.387E-08
NW	1.386E-05	3.830E-06	1.370E-06	7.517E-07	4.944E-07	2.397E-07	9.809E-08	5.290E-08	3.538E-08	2.624E-08
NNW	2.549E-05	7.081E-06	2.548E-06	1.402E-06	9.242E-07	4.498E-07	1.849E-07	1.001E-07	6.703E-08	4.976E-08
N	2.640E-05	7.275E-06	2.599E-06	1.424E-06	9.356E-07	4.528E-07	1.845E-07	9.915E-08	6.615E-08	4.897E-08
NNE	2.061E-05	5.617E-06	1.986E-06	1.082E-06	7.085E-07	3.410E-07	1.379E-07	7.372E-08	4.906E-08	3.626E-08
NE	1.800E-05	4.929E-06	1.749E-06	9.543E-07	6.251E-07	3.009E-07	1.217E-07	6.502E-08	4.323E-08	3.193E-08
ENE	1.715E-05	4.677E-06	1.656E-06	9.030E-07	5.914E-07	2.848E-07	1.152E-07	6.164E-08	4.103E-08	3.032E-08
E	1.821E-05	4.961E-06	1.751E-06	9.521E-07	6.221E-07	2.982E-07	1.198E-07	6.368E-08	4.221E-08	3.111E-08
ESE	2.834E-05	7.730E-06	2.730E-06	1.484E-06	9.699E-07	4.651E-07	1.870E-07	9.951E-08	6.602E-08	4.868E-08
SE	3.509E-05	9.697E-06	3.466E-06	1.899E-06	1.247E-06	6.035E-07	2.459E-07	1.322E-07	8.823E-08	6.534E-08
SSE	3.628E-05	1.013E-05	3.656E-06	2.015E-06	1.330E-06	6.485E-07	2.677E-07	1.453E-07	9.755E-08	7.255E-08

TABLE 3-11 (CONTD)

B) 2.260 DAY DECAY, UNDEPLETED
CHI/Q (SEC/METER CUBED) FOR EACH SEGMENT

DIRECTION FROM SITE	SEGMENT BOUNDARIES IN MILES FROM THE SITE									
	0-1	1-2	2-3	3-4	4-5	5-10	10-20	20-30	30-40	40-50
S	2.763E-05	7.701E-06	2.766E-06	1.515E-06	9.933E-07	4.745E-07	1.848E-07	9.291E-08	5.799E-08	4.022E-08
SSW	2.104E-05	5.933E-06	2.152E-06	1.186E-06	7.812E-07	3.766E-07	1.492E-07	7.615E-08	4.802E-08	3.355E-08
SW	1.203E-05	3.361E-06	1.208E-06	6.623E-07	4.343E-07	2.077E-07	8.127E-08	4.111E-08	2.581E-08	1.801E-08
WSW	6.405E-06	1.797E-06	6.466E-07	3.537E-07	2.313E-07	1.098E-07	4.210E-08	2.083E-08	1.286E-08	8.865E-09
W	4.001E-06	1.095E-06	3.867E-07	2.097E-07	1.363E-07	6.412E-08	2.424E-08	1.183E-08	7.228E-09	4.937E-09
WNW	7.732E-06	2.084E-06	7.250E-07	3.891E-07	2.510E-07	1.163E-07	4.274E-08	2.033E-08	1.222E-08	8.256E-09
NW	1.376E-05	3.776E-06	1.337E-06	7.256E-07	4.724E-07	2.229E-07	8.513E-08	4.216E-08	2.614E-08	1.810E-08
NNW	2.537E-05	7.013E-06	2.506E-06	1.369E-06	8.966E-07	4.286E-07	1.683E-07	8.590E-08	5.449E-08	3.842E-08
N	2.626E-05	7.199E-06	2.551E-06	1.387E-06	9.044E-07	4.289E-07	1.659E-07	8.349E-08	5.244E-08	3.668E-08
NNE	2.047E-05	5.544E-06	1.941E-06	1.047E-06	6.792E-07	3.187E-07	1.208E-07	5.960E-08	3.687E-08	2.548E-08
NE	1.784E-05	4.844E-06	1.696E-06	9.137E-07	5.910E-07	2.753E-07	1.025E-07	4.952E-08	3.013E-08	2.055E-08
ENE	1.701E-05	4.603E-06	1.610E-06	8.673E-07	5.613E-07	2.621E-07	9.803E-08	4.756E-08	2.901E-08	1.980E-08
E	1.808E-05	4.891E-06	1.707E-06	9.184E-07	5.938E-07	2.769E-07	1.037E-07	5.047E-08	3.090E-08	2.115E-08
ESE	2.813E-05	7.623E-06	2.663E-06	1.434E-06	9.278E-07	4.336E-07	1.634E-07	8.016E-08	4.941E-08	3.402E-08
SE	3.486E-05	9.574E-06	3.389E-06	1.840E-06	1.197E-06	5.654E-07	2.165E-07	1.075E-07	6.672E-08	4.615E-08
SSE	3.600E-05	9.979E-06	3.562E-06	1.942E-06	1.268E-06	6.016E-07	2.313E-07	1.150E-07	7.125E-08	4.919E-08

TABLE 3-11 (CONTD)

C) 8,000 DAY DECAY, DEPLETED
CHI/Q (SEC/METER CUBED) FOR EACH SEGMENT

DIRECTION FROM SITE	SEGMENT BOUNDARIES IN MILES FROM THE SITE									
	.5-1	1-2	2-3	3-4	4-5	5-10	10-20	20-30	30-40	40-50
S	2.487E-05	6.658E-06	2.286E-06	1.213E-06	7.751E-07	3.540E-07	1.275E-07	5.998E-08	3.588E-08	2.411E-08
SSW	1.892E-05	5.121E-06	1.774E-06	9.460E-07	6.067E-07	2.788E-07	1.015E-07	4.823E-08	2.906E-08	1.964E-08
SW	1.082E-05	2.904E-06	9.977E-07	5.294E-07	3.382E-07	1.545E-07	5.566E-08	2.623E-08	1.571E-08	1.058E-08
WSW	5.777E-06	1.559E-06	5.378E-07	2.856E-07	1.824E-07	8.320E-08	2.980E-08	1.391E-08	8.267E-09	5.523E-09
W	3.605E-06	9.486E-07	3.209E-07	1.688E-07	1.072E-07	4.847E-08	1.714E-08	7.924E-09	4.679E-09	3.111E-09
WNW	6.978E-06	1.811E-06	6.046E-07	3.155E-07	1.992E-07	8.908E-08	3.092E-08	1.406E-08	8.205E-09	5.403E-09
NW	1.239E-05	3.267E-06	1.106E-06	5.816E-07	3.693E-07	1.668E-07	5.900E-08	2.734E-08	1.619E-08	1.080E-08
NNW	2.280E-05	6.047E-06	2.061E-06	1.089E-06	6.935E-07	3.153E-07	1.129E-07	5.307E-08	3.181E-08	2.145E-08
N	2.362E-05	6.211E-06	2.101E-06	1.105E-06	7.013E-07	3.169E-07	1.123E-07	5.225E-08	3.110E-08	2.086E-08
NNE	1.843E-05	4.793E-06	1.604E-06	8.381E-07	5.298E-07	2.377E-07	8.323E-08	3.832E-08	2.263E-08	1.507E-08
NE	1.608E-05	4.201E-06	1.409E-06	7.367E-07	4.655E-07	2.085E-07	7.255E-08	3.311E-08	1.939E-08	1.282E-08
ENE	1.532E-05	3.988E-06	1.335E-06	6.977E-07	4.409E-07	1.976E-07	6.893E-08	3.155E-08	1.853E-08	1.227E-08
E	1.628E-05	4.232E-06	1.413E-06	7.366E-07	4.646E-07	2.075E-07	7.206E-08	3.291E-08	1.932E-08	1.281E-08
ESE	2.534E-05	6.595E-06	2.203E-06	1.149E-06	7.248E-07	3.241E-07	1.128E-07	5.170E-08	3.045E-08	2.024E-08
SE	3.137E-05	8.274E-06	2.799E-06	1.471E-06	9.331E-07	4.210E-07	1.487E-07	6.892E-08	4.086E-08	2.729E-08
SSE	3.242E-05	8.636E-06	2.949E-06	1.558E-06	9.928E-07	4.510E-07	1.609E-07	7.503E-08	4.461E-08	2.984E-08

TABLE 3-11 (CONTD)

D) TURBINE OR RADWASTE DEPOSITION, D/Q.
RELATIVE DEPOSITION PER UNIT AREA (M**2) BY DOWNWIND SECTORS

DIRECTION FROM SITE	SEGMENT BOUNDARIES IN MILES									
	5-1	1-2	2-3	3-4	4-5	5-10	10-20	20-30	30-40	40-50
S	2.664E-08	5.457E-09	1.425E-09	6.398E-10	3.620E-10	1.392E-10	4.027E-11	1.596E-11	8.523E-12	5.275E-12
SSW	1.853E-08	3.796E-09	9.909E-10	4.450E-10	2.518E-10	9.682E-11	2.801E-11	1.110E-11	5.928E-12	3.669E-12
SW	1.160E-08	2.375E-09	6.201E-10	2.785E-10	1.575E-10	6.058E-11	1.753E-11	6.947E-12	3.710E-12	2.296E-12
WSW	4.652E-09	9.529E-10	2.488E-10	1.117E-10	6.321E-11	2.431E-11	7.032E-12	2.787E-12	1.488E-12	9.212E-13
W	4.254E-09	8.714E-10	2.275E-10	1.022E-10	5.780E-11	2.223E-11	6.430E-12	2.549E-12	1.361E-12	8.424E-13
WNW	8.379E-09	1.716E-09	4.481E-10	2.012E-10	1.138E-10	4.378E-11	1.266E-11	5.020E-12	2.681E-12	1.659E-12
NW	1.761E-08	3.608E-09	9.419E-10	4.230E-10	2.393E-10	9.203E-11	2.662E-11	1.055E-11	5.635E-12	3.488E-12
NNW	3.707E-08	7.593E-09	1.982E-09	8.903E-10	5.036E-10	1.937E-10	5.603E-11	2.221E-11	1.186E-11	7.340E-12
N	4.270E-08	8.746E-09	2.283E-09	1.025E-09	5.801E-10	2.231E-10	6.454E-11	2.558E-11	1.366E-11	8.455E-12
NNE	3.448E-08	7.062E-09	1.844E-09	8.280E-10	4.684E-10	1.801E-10	5.211E-11	2.065E-11	1.103E-11	6.827E-12
NE	2.465E-08	5.050E-09	1.318E-09	5.921E-10	3.349E-10	1.288E-10	3.726E-11	1.477E-11	7.887E-12	4.881E-12
ENE	2.235E-08	4.579E-09	1.195E-09	5.368E-10	3.037E-10	1.168E-10	3.379E-11	1.339E-11	7.151E-12	4.426E-12
E	2.363E-08	4.841E-09	1.264E-09	5.676E-10	3.211E-10	1.235E-10	3.572E-11	1.416E-11	7.560E-12	4.679E-12
ESE	3.810E-08	7.804E-09	2.037E-09	9.150E-10	5.176E-10	1.991E-10	5.759E-11	2.282E-11	1.219E-11	7.544E-12
SE	4.168E-08	8.537E-09	2.229E-09	1.001E-09	5.663E-10	2.178E-10	6.300E-11	2.497E-11	1.333E-11	8.253E-12
SSE	3.672E-08	7.521E-09	1.963E-09	8.818E-10	4.988E-10	1.918E-10	5.550E-11	2.200E-11	1.175E-11	7.270E-12

Table 3-13

CHARACTERISTICS OF WNP-2 GASEOUS EFFLUENT RELEASE POINTS

	<u>Reactor Building</u>	<u>Radwaste Building</u>	<u>Turbine Building</u>
Height of release point above ground level (m)	70.3	20.4	36.3
Annual average rate of air flow from release point (m ³ /sec)	37.8	39.2	169.9
Annual average heat flow from release point (cal/sec)	1.06 x 10 ⁶	2.9 x 10 ⁶	9.1 x 10 ⁵
Type and size of release point (m)	Duct 1.14 x 3.05	3 Louver houses, Each 1.37 x 2.44 x 0.75	4 Exhaust fans, Each 1.45 x 2.01
Effective vent area (m ²)	3.48	11.58**	8.74***
Vent velocity (m/sec)*	10.9	3.4	19.5
Effective diameter (m) ($\pi r^2 = \text{area}$)	2.1	3.8	3.3
Building height (m)	70.1	31.8****	42.4

*Reactor Building exhaust in vertical direction. Radwaste and Turbine Building exhaust in horizontal plane.

**Equivalent to two vents (as per FSAR Section 9.4.3.2, 2 of 3 will normally be in operation).

***Equivalent to three vents (as per FSAR Section 9.4.6.2.2, 3 of 4 will normally be in operation).

****Height of the Radwaste and Control Building.

Table 3-14

REFERENCES FOR VALUES LISTED IN TABLES 3-8 and 3-9

- | | |
|--------------|--|
| Reference 1 | U.S. Map |
| Reference 2 | Site Specific |
| Reference 3 | Regulatory Guide 1.109, Revision 1, Table E-15 |
| Reference 4 | Section 2.3, WNP-2 FSAR, Table 2.3-1 |
| Reference 5 | Section 2.3, WNP-2 FSAR, page 2.3-3 |
| Reference 6 | WNP-1 & WNP-2 Emergency Preparedness Plan Table 12.1, Permanent Population Distribution, Rev 5, Feb. 88 |
| Reference 7 | 1986 50-Mile Land Use Census, WPPSS REMP |
| Reference 8 | WNP-2 Effluent Analysis for Applicable Time Period |
| Reference 9 | Health Physics Calculation Log No. 93-2 |
| Reference 10 | NUREG/CR-2919 XOQDOQ: Computer Program For The Meteorological Evaluation of Routine Effluent Releases at Nuclear Power Stations, September 1982. |

Table 3-15
DESIGN BASE PERCENT NOBLE GAS (30-MINUTE DECAY)*

<u>Isotope</u>	<u>Percent of Total Activity</u>
Kr-83M	2.9
Kr-85M	5.6
Kr-85	0
Kr-87	15
Kr-88	18
Kr-89	0.2
Xe-131M	0.02
Xe-133M	0.3
Xe-133	8.2
Xe-135M	6.9
Xe-135	22
Xe-137	0.7
Xe-138	21

*From Table 11.3-1 WNP-2 FSAR

TABLE 3-16

ANNUAL DOSES AT TYPICAL LOCATIONS

Source: WNP-2 Gaseous Effluent

Location	Distance (Miles)	Occupancy (hrs/yr)	Whole Body Dose (mrem/yr)	Thyroid Dose (mrem/yr)
BPA Ashe Substation	0.5 N	2080	1.1E+00	1.7E+00
DOE Train	0.5 SE*	78	6.7E-02	1.0E-01
Wye Burial Site	0.5 WNW	8	4.1E-03	6.5E-03
WNP-1	1.2 ESE	2080	3.8E-02	1.3E-01
WNP-4	1.0 ENE	2080	7.0E-02	1.1E-01
WNP-2 Visitor Center	0.08 ESE	8	8.6E-02	1.3E-01
Taylor Flats**	4.2 ESE	8760	3.1E-02	5.2E+00
Site Boundary***	1.2 SE	8760	1.1E+00	1.7E+00

* The sector with the highest X/Q values (within 0-0.5 mile radius) was used.

** Closest residential area representative of maximum individual dose from plume, ground, ingestion, and inhalation exposure pathways. Included for comparison.

*** Assumed continuously occupied. Actual occupancy is very low. Doses from Inhalation and Ground Exposure pathways. No food crops.

TABLE 3-17

ANNUAL OCCUPIED AIR DOSE AT TYPICAL LOCATIONS

<u>Location</u>	<u>Annual Beta Air dose (mrad)</u>	<u>Annual Gamma Air Dose</u>
BPA Ashe Substation	8.9E-01	1.5E+00
DOE Train	5.3E-02	9.2E-02
Wye Burial Site	3.2E-03	5.7E-03
WNP-1	3.3E-02	2.8E-02
WNP-4	5.3E-02	8.5E-02
WNP-2 Visitor Center	7.0E-02	1.2E-01
Taylor Flats*	2.3E-02	1.4E-02
Site Boundary	8.7E-01	1.5E+00

*Closest residential area.

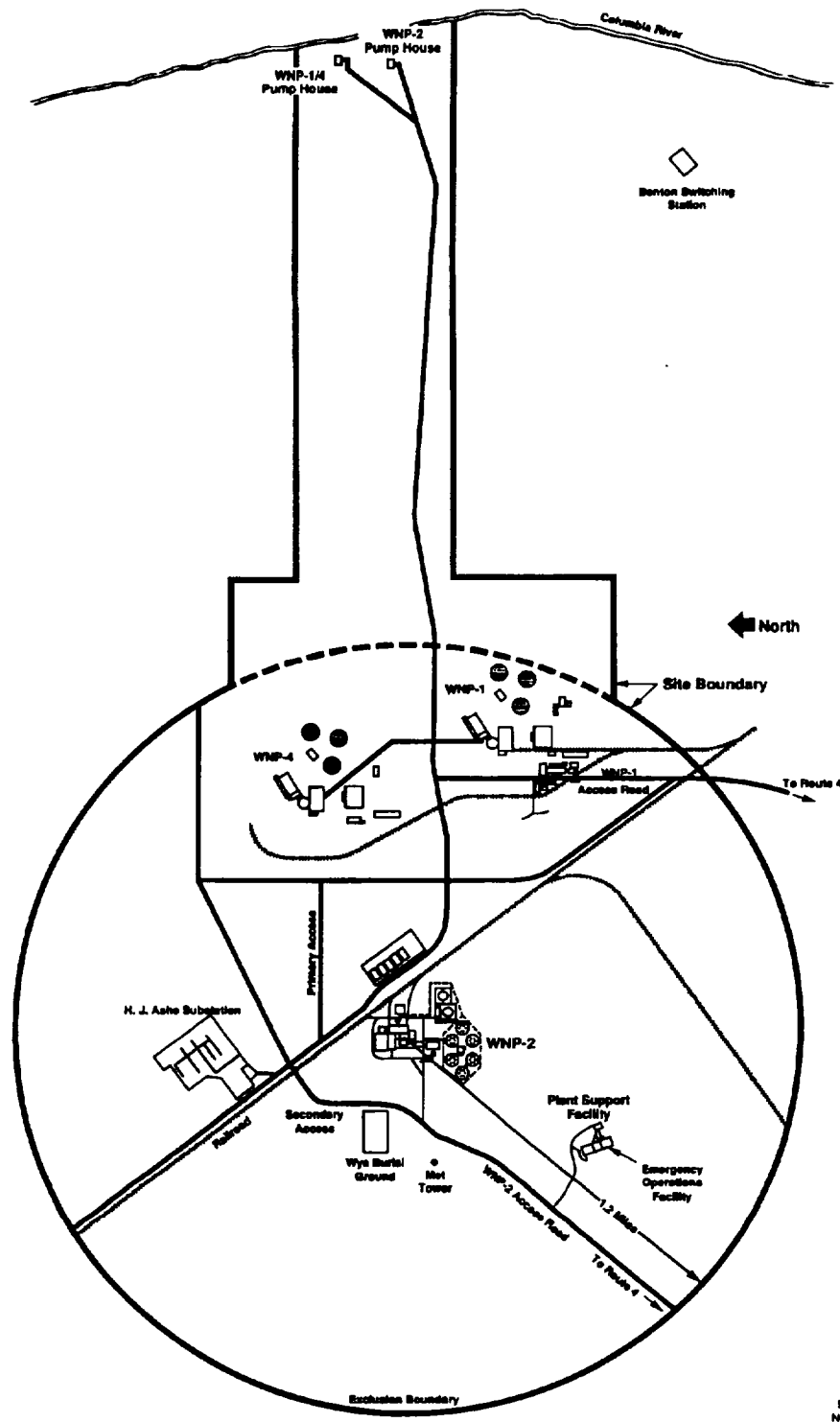

SITE BOUNDARY FOR RADIOACTIVE GASEOUS
AND LIQUID EFFLUENTS

Figure 3-1

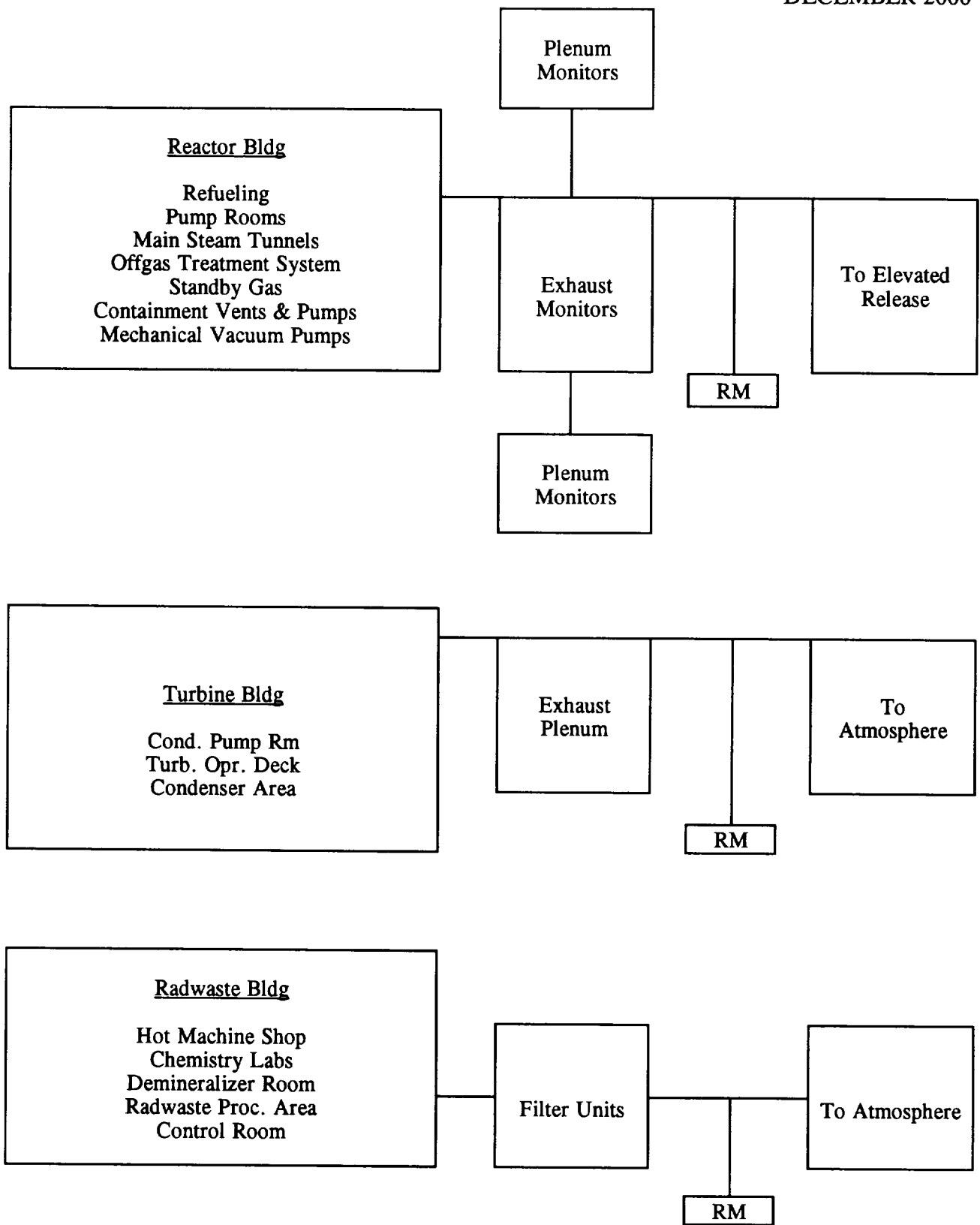

SIMPLIFIED BLOCK DIAGRAM OF
GASEOUS WASTE SYSTEM
Figure 3-2

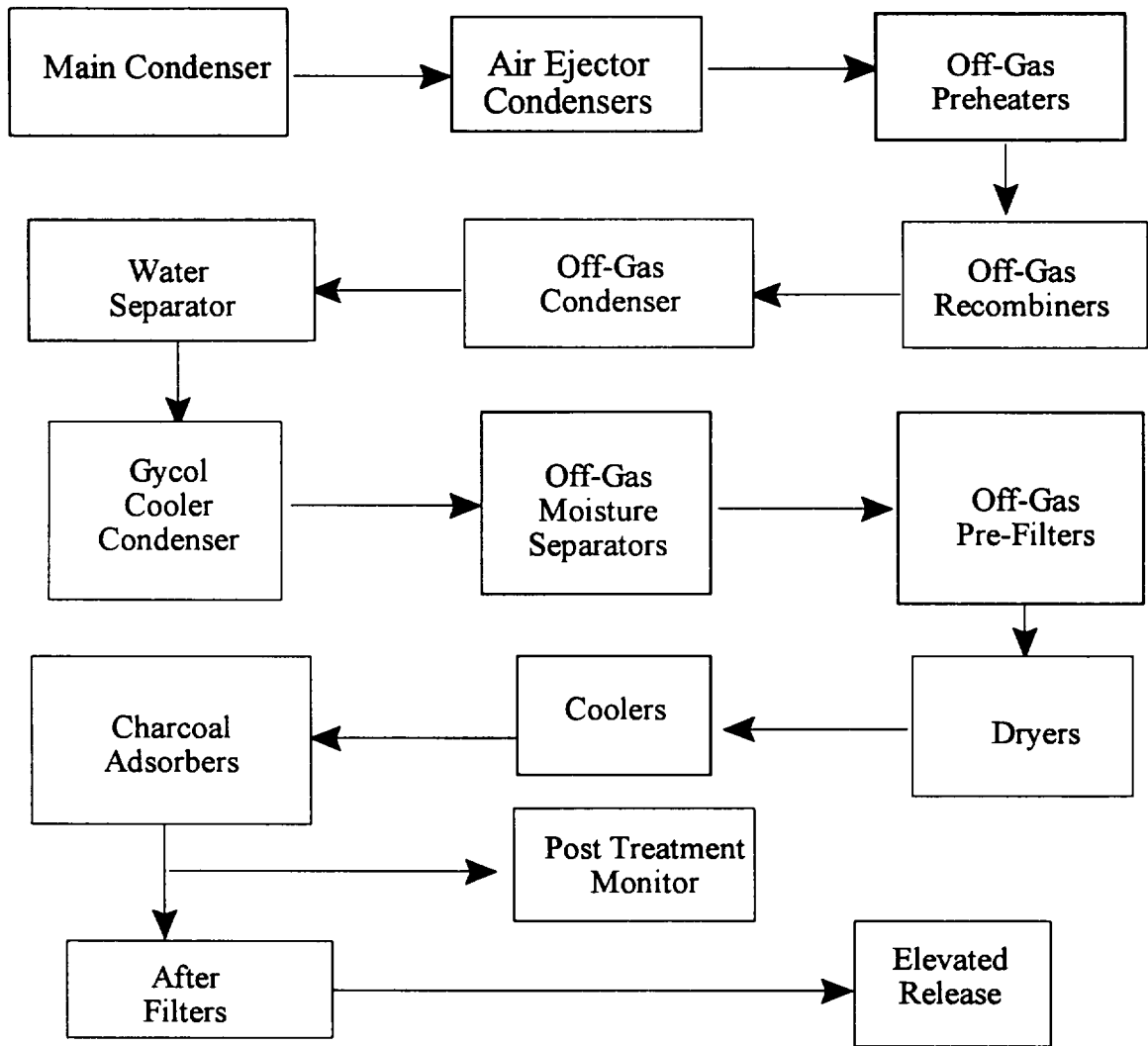

SIMPLIFIED BLOCK DIAGRAM
OF
OFF-GAS TREATMENT SYSTEM

Figure 3-3

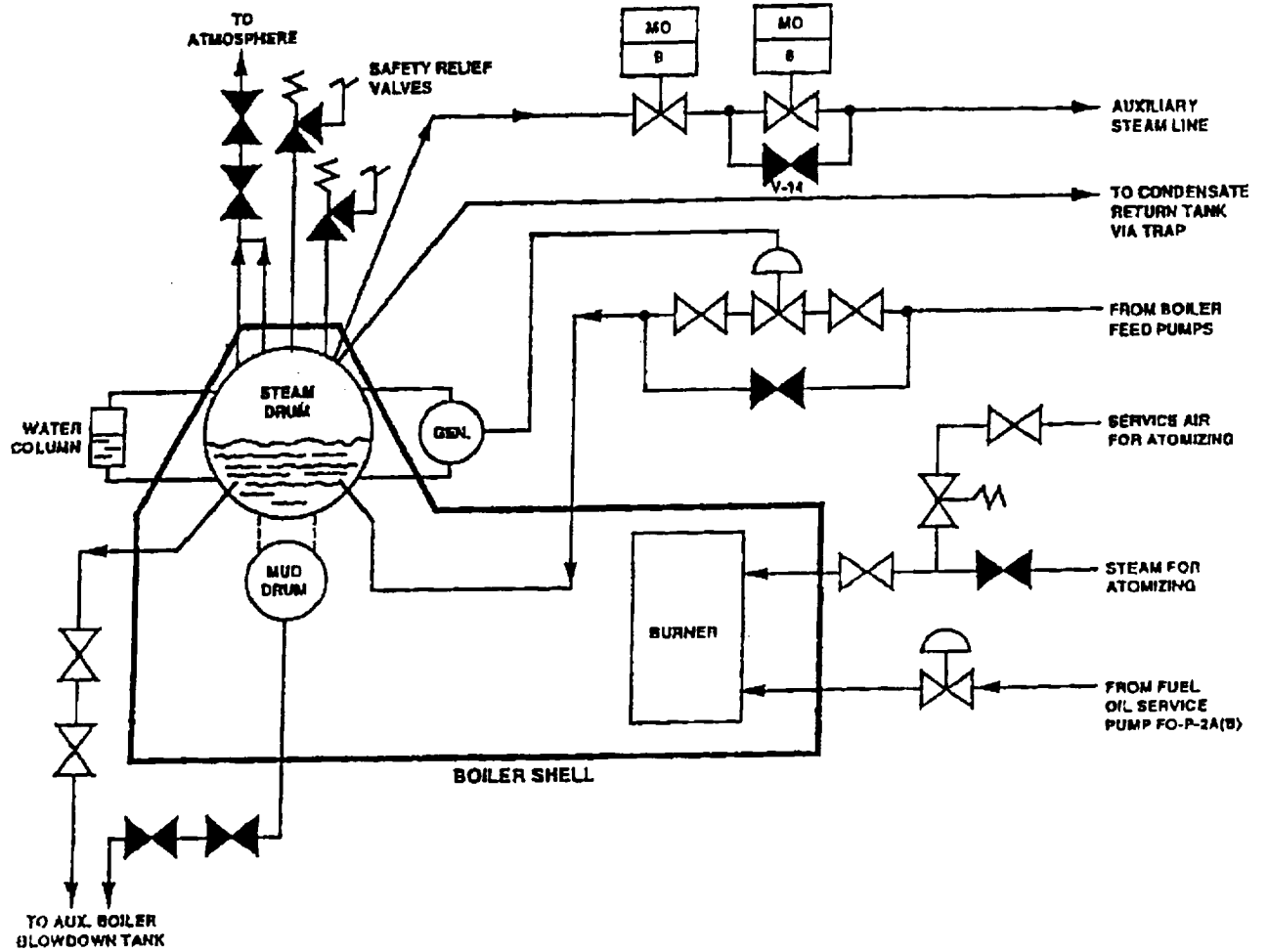

AUXILIARY BOILER
Figure 3-4

4.0 COMPLIANCE WITH 40 CFR 190

4.1 Requirement For Operability

Requirement for Operability 6.2.4.1 states, "The annual (calendar year) dose or dose commitment to any Member of the Public, due to releases of radioactivity and radiation, from uranium fuel cycle sources shall be limited to less than or equal to 25 mrems to the total body or any organ, except the thyroid, which shall be limited to less than or equal to 75 mrems."

4.2 ODCM Methodology for Determining Dose and Dose Commitment from Uranium Fuel Cycle Sources

The annual dose or dose commitment to a Member of the Public for the uranium fuel cycle sources is determined as:

- a) Dose to the total body due to the release of radioactive materials in liquid effluents.
- b) Dose to any organ due to the release of radioactive materials in liquid effluents.
- c) Air doses due to noble gases released in gaseous effluents.
- d) Dose to any organ due to the release of radioiodines, tritium and radionuclides in particulate form with half-lives greater than 8 days in gaseous effluents.
- e) Dose due to direct radiation from the plant.

The annual dose or dose commitment to a Member of the Public from the uranium fuel cycle sources is determined whenever the calculated doses from the release of radioactive materials in liquid or gaseous effluents exceed twice the limits in Requirement for Operability 6.2.1.2.a, 6.2.1.2.b, 6.2.2.2.a, 6.2.2.2.b, 6.2.2.3.a, or 6.2.2.3.b. Direct radiation measurements will also be made to determine if the limits of Requirement for Operability 6.2.4.1 have been exceeded.

4.2.1 Total Dose from Liquid Effluents

The annual dose to a Member of the Public from liquid effluents will be determined using NRC LADTAP II computer code, and methodology presented by Equation (5) in Section 2.4. It is assumed that dose contribution pathways to a Member of the Public do not exist for areas within the site boundary.

4.2.2 Total Dose from Gaseous Effluents

The annual dose to a Member of the Public from gaseous effluents will be determined using NRC GASPARI computer code, and methodology presented by Equations (10), (11) and (13) in Section 3.4. Appropriate atmospheric dispersion parameters will be used.

4.2.3 Direct Radiation Contribution

The dose to a Member of the Public due to direct radiation from the reactor plant will be determined using thermoluminescent dosimeters (TLDs) or may be calculated. TLDs are placed at sample locations and analyzed as per Table 5-1. The direct radiation contribution will be documented in the Radioactive Effluent Release Report submitted 60 days after January 1 of each year.

5.0 RADIOLOGICAL ENVIRONMENTAL MONITORING

Radiological environmental monitoring is intended to supplement radiological effluent monitoring by verifying that measurable concentrations of radioactive materials and levels of radiation in the environment are not greater than expected based on effluent measurement and dose modeling of environmental exposure pathways. The Radiological Environmental Monitoring Program (REMP) for WNP-2 provides for measurements of radiation and radioactive materials in those exposure pathways and for those radionuclides for which the highest potential dose commitment to a Member of the Public would result due to plant operations.

The WNP-2 REMP is designed to conform to regulatory guidance provided by Regulatory Guide 4.1, 4.8, 4.15 and the Radiological Assessment Branch Technical Position (BTP), taking into consideration certain site specific characteristics. The unique nature of the WNP-2 site on Federally owned and administered land (Hanford Reservation) dedicated to energy facilities, research, waste management and as a natural reserve, forms the basis for many of the site specific parameters. Amongst the many site specific parameters considered is demographic data such as:

- 1) No significant clusters of population including schools, hospitals, business facilities or primary public transportation routes are located within 8 km (5 mile) radius of the plant.
- 2) No private residences are located on the Hanford Reservation.
- 3) The closest resident is east of the Columbia River at a distance of approximately 4 miles.

Radiological environmental monitoring activities implemented by PPM 1.11.1 "Radiological Environmental Monitoring Program (REMP) Implementation Procedure", as detailed in the following sections, meet or exceed the criteria of the REMP plan as specified by Requirement for Operability, 6.3.1.1.

5.1 Radiological Environmental Monitoring Program (REMP)

Environmental samples for the REMP are collected in accordance with Table 5-1. This table provides a detailed outline of the Requirement for Operability environmental sampling plan items by sample type, sample location code, sampling and collection frequency, and type and frequency of analysis of samples collected within exposure pathway. Deviations from the sampling frequency detailed in Table 5-1 may occur due to circumstances such as hazardous conditions, malfunction of automatic sampling equipment, seasonal unavailability, or other legitimate reasons. When sample media is unobtainable due to equipment malfunction, special actions per program instruction shall be taken to ensure that corrective action is implemented prior to the end of the next sampling period. In some cases, alternate sample collection may be substituted for the missing specimen. All deviations from the sampling plan Requirement for Operability items detailed in the sampling plan, Table 5-1, shall be documented and reported in the Annual Radiological Environmental Operating Report in accordance with PPM 1.10.2, "Routine or Periodic Reports Required by Regulatory Agencies", Regulatory Guide 4.8 and BTP.

In the event that it becomes impossible or impractical to continue sampling a media of choice at currently established location(s) or time, an evaluation shall be made to determine a suitable alternative media and/or location to provide appropriate exposure pathway evaluations. The evaluation and any substitution made shall be implemented in the sampling program within 30 days of identification of the problem. All changes implemented in the sampling program due to unavailability of samples shall be fully documented in the next Radioactive Effluent Release Report and ODCM per PPM 1.10.1, "Reportable Events and Occurrences Required by Regulatory Agencies". Revised sampling plan table(s) and figure(s) reflecting the new locations and/or media shall be included with the documentation.

WNP-2 sampling stations are described in Table 5-2. Each station is identified by an assigned number or alphanumeric designation, meteorological sector (16 different, 22-1/2° compass sections) in which the station is located, and radial distance from WNP-2 containment as estimated from map positions. Also included in Table 5-2 is information identifying the type(s) of samples collected at each station and whether or not the specific sample type satisfies a Requirement for Operability criteria. Figures 5-1 and 5-2 depict the geographical locations of each of the sample stations listed in Table 5-2.

5.2 Land Use Census

A Land Use Census shall be conducted in accordance with the requirements of Requirement for Operability 6.3.2.1. It shall identify within a distance of 8 km (5 miles) in each of the 16 meteorological sectors, the location of the nearest milk animal, the nearest residence and the nearest garden of greater than 50m² (500 ft²) producing broad leaf vegetation. Field activities pertaining to the Land Use Census will be initiated during the growing season and completed no later than September 30 each year. The information obtained during the field survey is used along with other demographic data to assess population changes in the unrestricted area that might require modifications in the sampling plan to ensure adequate evaluation of dose or dose commitment.

The results of the Land Use Census will be submitted no later than October 31 of each year for evaluation of maximum individual doses or dose commitment. All changes, such as a location yielding a greater estimated dose or dose commitment or different location with a 20 percent greater estimated dose or dose commitment than a currently sampled location, will be reported in the next Radioactive Effluent Release Report in accordance with PPM 1.10.2 and Requirement for Operability 6.3.2.1. The REMP plan, ODCM, will be changed to reflect new sampling location(s). The new sampling location(s) will be added to the REMP within 30 days.

The best available census information, whether obtained by aerial survey, door-to-door survey, or consultation with local authorities, shall be used to complete the Land Use Census and the census results shall be reported in the Annual Radiological Environmental Operating Report, in accordance with PPM 1.10.2 and Technical Specification requirements.

5.3 Laboratory Intercomparison Program

Analysis of REMP samples is contracted to a provider of radiological analytical services. By contract, this analytical service vendor is required to conduct all activities in accordance with Regulatory Guides 4.1, 4.8, and 4.15 and to include in each quarterly report, actions pertinent to their participation in the Interlaboratory Comparison Program. A precontract award survey and periodic audit at the contractor's facility ensure that the contractor is participating in the Crosscheck Program, as reported.

The results of the contractor's analysis of Crosscheck samples shall be included in the Annual Radiological Environmental Operating Report in accordance with PPM 1.10.2 and Requirement for Operability 6.3.3.1.

Besides the vendor's required participation in the Interlaboratory Comparison Program, the Department of Health (DOH) of the State of Washington oversees an analytical program for the Energy Facility Site Evaluation Council (EFSEC) to provide an independent test of WNP-2 REMP sample analyses. The WNP-2/DOH split samples are analyzed by Washington State's Office of Public Health Laboratories and Epidemiology, Environmental Radiation Laboratory (ERL). The results of the ERL analysis and Interlaboratory Comparison Program data are included in an annual report, "Environmental Radiation Program, Environmental Health Surveillance, State of Washington" and is available for comparison with the WNP-2 data.

Energy Northwest participates in the International Intercomparison of Environmental Dosimeter Program. Results of this intercomparison program are reported in the REMP Annual Report, when available.

5.4 Reporting Requirements

WNP-2 radiological environmental monitoring program activities are presented annually per PPM 1.10.2 in the Annual Radiological Environmental Operating Report (AREOR). The approved report is submitted to the Administrator, Region IV Office of Inspection and Enforcement, with copies to the Director, Office of Nuclear Reactor Regulation, and the State of Washington Energy Facility Site Evaluation Council (EFSEC) and Radiation Control Section, DOH, by May 15 of each year for program activities conducted the previous calendar year. The period of the first operational report begins with the date of initial criticality.

The annual report is to include the following types of information: a tabulated summary; interpretations and analyses of trends for results of radiological environmental surveillance activities for the report period, including comparisons with operational controls, preoperational studies, and previous environmental surveillance reports as appropriate; an assessment of the observed impacts of plant operation on the environment; a brief description of the radiological environmental monitoring program; maps representing sampling station locations, keyed to tables of distance and direction from reactor containment; results of the Land Use Census; and the results of analytical laboratory participation in the Interlaboratory Comparison Program. The tabulated summary shall be presented in a format represented in Table 5-3. A supplementary report is required if all analytical results are not available for inclusion in the annual report within the specified time frame. The missing data shall be submitted as soon as possible upon receipt of the results. Along with the missing data, the supplementary report shall include an explanation as to the cause for the delay in completion of the analysis within the report period.

A nonroutine radiological environmental operating report is required to be submitted within 30 days from the end of any quarter in which a confirmed measured radionuclide concentration in an environmental sample averaged over the quarter sampling period exceeds a reporting level. Table 5-4 specifies the reporting level (RL) for most radionuclides of environmental importance due to potential impact from plant operations. When more than one of the nuclides listed in Table 5-4 is detected in a sample, the reporting level is considered to be exceeded and a nonroutine report required if the following conditions are satisfied:

$$\frac{\text{Concentration (1)}}{\text{Reporting Level (1)}} + \frac{\text{Concentration (2)}}{\text{Reporting Level (2)}} + \dots \geq 1$$

For radionuclides other than those listed in Table 5-4, the reporting level is considered to have been exceeded if the potential annual dose to an individual is greater than or equal to the design objective doses of Appendix I, 10 CFR 50. When a nonroutine report on an unlisted (Table 5-4) radionuclide must be issued, it shall include an evaluation of any release conditions, environmental factors, or other aspects necessary to explain the anomalous sample results.

When it can be demonstrated that the anomalous sample result(s) exceeding reporting levels is not the result of plant effluents, a nonroutine report does not have to be submitted. A full discussion of the sample result and subsequent evaluation or investigation of the anomalous result will be included in the Annual Radiological Environmental Operational Report.

TABLE 5-1
RADIOLOGICAL ENVIRONMENTAL MONITORING PROGRAM PLAN

<u>Sample Type</u>	<u>Sample Location Code*</u>	<u>Sampling and Collection Frequency¹</u>	<u>Type and Frequency of Analysis¹</u>
1. AIRBORNE			
a. Particulates and radioiodine	4, 8, 9A, 40, 48, 57	Continuous sampling Weekly collection	<u>Particulate</u> : Gross beta ² , weekly; gamma isotopic ³ , quarterly composite (by location) <u>Radioiodine</u> : I-131 analysis, weekly
2. DIRECT RADIATION			
TLD ⁴	1, 2, 4-9A, 10, 13-20, 22, 24, 25, 40-46, 49-51, 53-56	Quarterly, annually	TLD converted to exposure quarterly and annually
3. WATERBORNE			
a. Surface/Drinking ⁶	26, 27, and 29	Composite aliquots ⁵ , monthly	Gamma isotopic ³ , gross beta, monthly; tritium, quarterly composite strontium-90, iodine-131, when requested ⁶
b. Ground water	31 and 52	Quarterly	Gamma isotopic ³ and tritium, quarterly
c. Sediment from shoreline	34	Semiannually	Gamma isotopic ³ , semiannually
4. INGESTION			
a. Milk ⁷	9B, 36, 64	Semimonthly during grazing season, monthly at other times	Gamma isotopic ³ and iodine-131, monthly/ semimonthly strontium-90, when requested ⁷
b. Fish ⁸	30, 38	Annually, unless an impact is indicated, then semiannually ⁸	Gamma isotopic ³ , when sampled

TABLE 5-1
RADIOLOGICAL ENVIRONMENTAL MONITORING PROGRAM PLAN

<u>Sample Type</u>	<u>Sample Location Code*</u>	<u>Sampling and Collection Frequency¹</u>	<u>Type and Frequency of Analysis¹</u>
c. Garden produce ⁹	9C, 37	Monthly during growing season in the Riverview area of Pasco and a control near Grandview.	Gamma isotopic ³ , when sampled

*Sample locations are graphically depicted in Figures 5-1 and 5-2.

¹Deviations are permitted if samples are unobtainable due to hazardous conditions, seasonal availability, malfunction of automatic sampling equipment, or other legitimate reasons. All deviations will be documented in the Annual Radiological Environmental Monitoring Report.

²Particulate sample filters will be analyzed for gross beta after at least 24-hour decay. If gross beta activity is greater than 10 times the yearly mean of the control sample, gamma isotopic analysis shall be performed on the individual sample.

³Gamma isotopic means identification and quantification of gamma-emitting radionuclides that may be attributable to the effluents of the facility.

⁴TLD refers to thermoluminescent dosimeter. For purposes of WNP-2 REMP, a TLD is a phosphor card with multiple read-out areas in each badge case. TLDs used in REMP meet the requirements of Regulatory Guide 4.13 (ANSI N545-1975), except for specified energy-dependence response. Correction factors are available for energy ranges with response outside of the specified tolerances.

⁵Composite samples will be collected with equipment which is capable of collecting an aliquot at time intervals which are short relative to the compositing period and in which the method of sampling employed results in a specimen that is representative of the liquid flow.

⁶Station 26, WNP-2 makeup water intake from the Columbia River, satisfies the Requirement for Operability criteria for upstream surface water and drinking water control samples. The discharge water (Station 27) samples are used to fulfill the Requirement for Operability criteria for a downstream sample. However, they provide very conservative estimates of downstream concentrations. Drinking water samples are not routinely analyzed for I-131 from two week composite, but I-131 analysis will be performed when the calculated dose for the consumption of water is greater than 1 mrem per year to the maximum organ. When the gross beta result in drinking water is greater than ten times the mean of the previous month's data for the control location or greater than 8 pCi/liter, Sr-90 analysis shall be performed.

TABLE 5-1 (contd.)

⁷Milk samples will be obtained from farms or individual milk animals which are located in sectors with high calculated annual average ground-level D/Qs and high dose potential. There are no milk animals located within 5 km of WNP-2. If cesium-134 or cesium-137 is measured in an individual milk sample in excess of 30 pCi/l, then strontium-90 analysis shall be performed.

⁸There are no commercially important species in the Hanford reach of the Columbia River. Most recreationally important species in the area are anadromous, primarily salmonids. Three species will normally be collected by electroshock technique in the vicinity of the plant discharge (Station 30). If electroshocking produces insufficient fish samples, anadromous species may be obtained from Ringold Fish Hatchery. Control samples are normally collected from the Snake River, in the vicinity of Ice Harbor Dam (salmonids may be obtained through the National Marine Fisheries Service at Lower Granite Dam). Three species (same ones obtained from the Columbia River) will be collected from the control location. If any of the analytical results of the Columbia River fish samples are significantly higher than the results of the Snake River samples or the results of previous fish samples, sampling will be conducted semiannually.

⁹Garden produce will routinely be obtained from farms or gardens using Columbia River water for irrigation. One sample of a root crop, leafy vegetable, and a fruit should be collected each sample period if available. The variety of the produce sample will be dependent on seasonal availability.

TABLE 5-2
WNP-2 REMP LOCATIONS

<u>Station</u>	<u>Sector</u>	<u>Radial Miles*</u>	<u>TLD</u>	<u>AP/AI</u>	<u>SW</u>	<u>DW</u>	<u>GW</u>	<u>SE</u>	<u>MI</u>	<u>FI</u>	<u>GP</u>
1	S	1.3	0								
2	NNE	1.8	0								
4	SSE	9.3	0	0							
5	ESE	7.7	0								
6	S	7.7	0								
7	WNW	2.7	0								
8	ESE	4.5	0	0							
9A*	WSW	30.0	0	0							
9C	WSW	33.0									0
10	E	3.1	0								
13	SW	1.4	0								
14	WSW	1.4	0								
15	W	1.4	0								
16	WNW	1.4	0								
17	NNW	1.2	0								

TABLE 5-2 (Continued)

<u>Station</u>	<u>Sector</u>	<u>Radial Miles^a</u>	<u>TLD</u>	<u>AP/AI</u>	<u>SW</u>	<u>DW</u>	<u>GW</u>	<u>SE</u>	<u>MI</u>	<u>FI</u>	<u>GP</u>
18	N	1.1	0								
19	NE	1.8	0								
20	ENE	1.9	0								
22	E	2.1	0								
24	SE	1.9	0								
25	SSE	1.6	0								
26*	E	3.2			0	0					
27	E	3.2			0						
29	SSE	11.0				0					
30	E	3.3								0	
31	ESE	1.1					0				
34	ESE	3.5						0			
36	ESE	7.2							0		
37	SSE	17.0									0
38*	E	26.5								0	

TABLE 5-2 (Continued)

<u>Station</u>	<u>Sector</u>	<u>Radial Miles*</u>	<u>TLD</u>	<u>AP/AI</u>	<u>SW</u>	<u>DW</u>	<u>GW</u>	<u>SE</u>	<u>MI</u>	<u>FI</u>	<u>GP</u>
40	SE	6.4	0	0							
41	SE	5.8	0								
42	ESE	5.6	0								
43	E	5.8	0								
44	ENE	5.8	0								
45	ENE	4.3	0								
46	NE	5.0	0								
48	NE	4.5		0							
49	NW	1.2	0								
50	SSW	1.2	0								
51	ESE	2.1	0								
52	N	0.1					0				
53	N	7.5	0								
54	NNE	6.5	0								
55	SSE	6.2	0								
56	SSW	7.0	0								
57	N	0.8		0							
64	ESE	9.9									0
96*	WSW	36.0									0

TABLE 5-2 (Continued)

<u>Station</u>	<u>Sector</u>	<u>Radial Miles'</u>	<u>TLD</u>	<u>AP/AI</u>	<u>SW</u>	<u>DW</u>	<u>GW</u>	<u>SE</u>	<u>MI</u>	<u>FI</u>	<u>GP</u>
*Control location.											
O	-										
a	-										
TLD	=										
AP/AI	=										
SW	=										
DW	=										
GW	=										
SE	=										
MI	=										
FI	=										
GP	=										

Radiological Environmental Requirement for Operability sample collected at station.
Estimated from center of WNP-2 Containment from map positions.

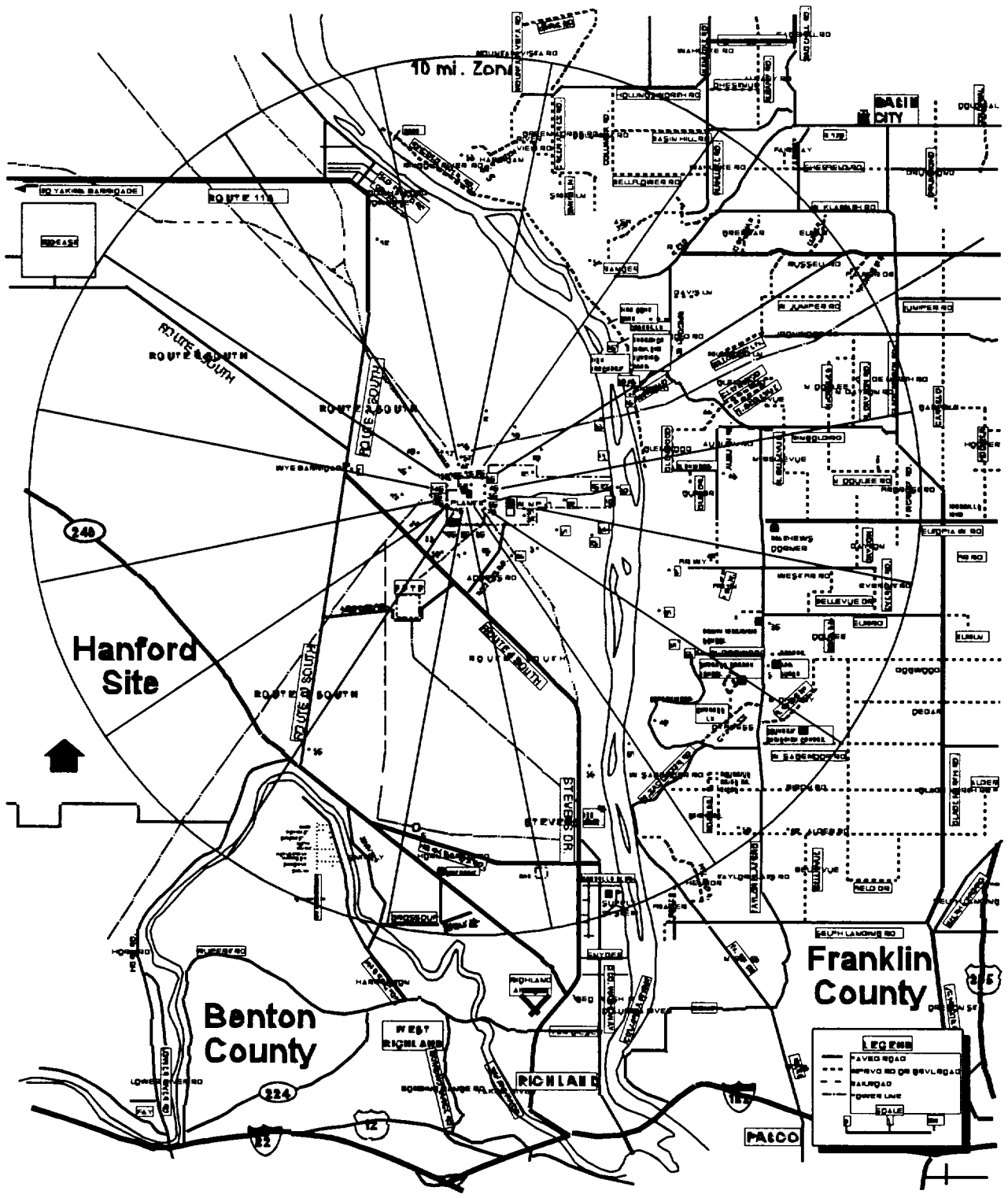

0005 15. 11
Oct 1999

RADIOLOGICAL ENVIRONMENTAL MONITORING SAMPLE LOCATIONS
INSIDE OF 10 MILE RADIUS

Figure 5-1

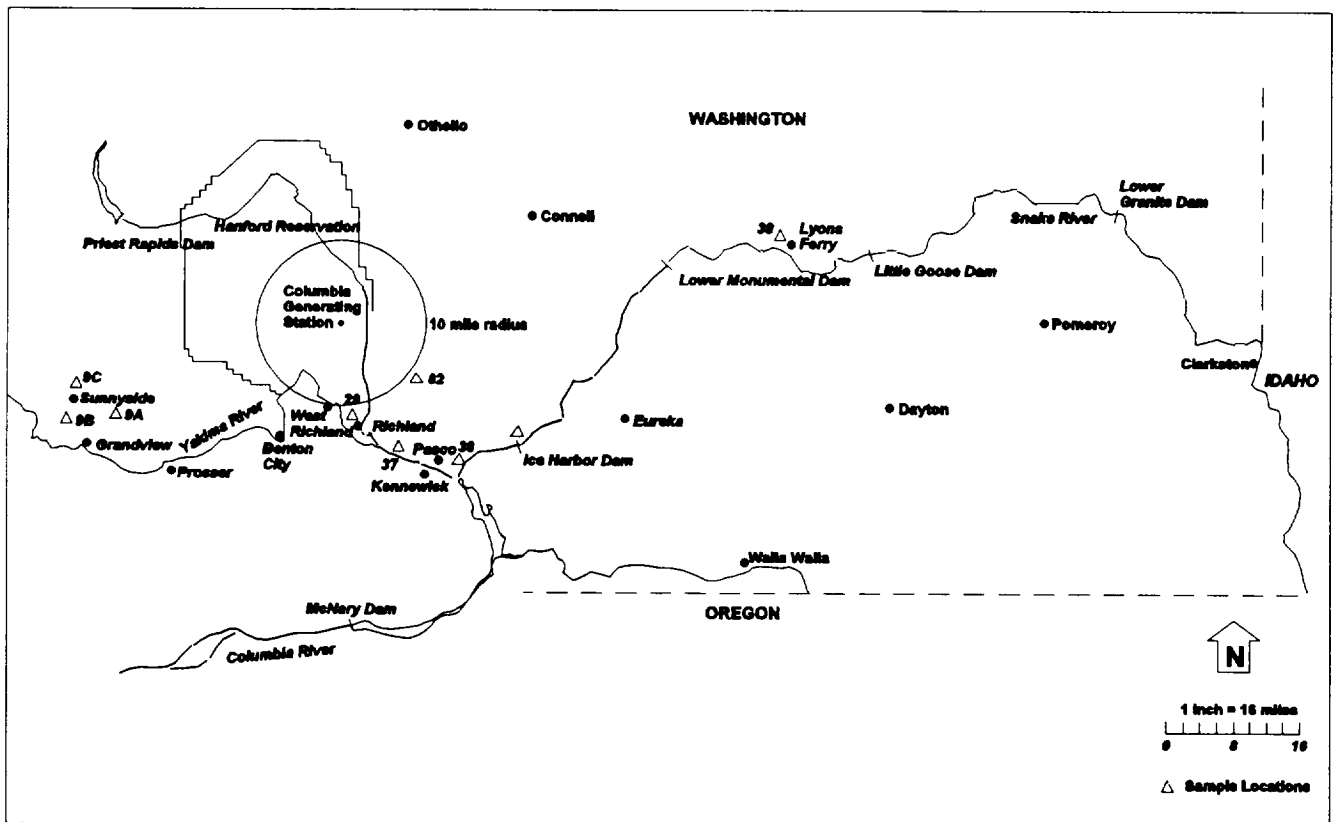

900296A1
OCT 2000

Radiological Environmental Monitoring Sample Locations Outside of 10-Mile Radius

Figure 5-2

Radiological Environmental Monitoring Sample Locations Near Plant 2

Figure 5-3

TABLE 5-3
ENVIRONMENTAL RADIOLOGICAL MONITORING PROGRAM ANNUAL SUMMARY*

Name of Facility _____ Docket No. _____
Location of Facility _____ Reporting Period _____
(County, State)

Medium or Pathway Sampled (Unit of Measurement)	Location with Highest				Location with Highest Annual Mean			Number of Nonroutine Reported Measurements
	Type and Total Number of Analysis Performed	Lower Limit of Detection (LLD)	All Indicator Locations Mean (f) Range	Name	Mean (f) Range	Control Locations Mean (f) Range		
							Distance and Direction	
Air particulates (pCi/m ³)	Gross γ 416	0.01	0.08 (200/312) (0.05-2.0)	Middletown	0.10 (5/52) (0.08-2.0)	0.08 (8/104) (1.05-1.40)	1	
	γ -Spec 32							
	137 _{Ca}	0.01	0.05 (4/24) (0.03-0.13)	Smithville	0.08 (2/4) (0.03-2.0)	LLD	4	
	131 _I	0.07	0.12 (2/24) (0.09-0.18)	Podunk	0.20 (2/4) (0.10-0.31)	0.02 (2/4)	1	
Fish (pCi/kg) (wet weight)	γ -Spec. 8							
	137 _{Ca}	130	LLD		LLD	90 (1/4)	0	
	134 _{Ca}	130	LLD		LLD	LLD	0	
	60 _{Co}	130	180 (3/4) (150-225)	River Mile 35	See Column 4	LLD	0	

*Summary Table is taken from the NRC's Branch Technical Position, Rev. 1, Nov. 1979, and provided for illustrative purposes only.

†Mean and range based upon detectable measurements only. Fraction of detectable measurements at specified locations is indicated in parentheses (f).

TABLE 5-4
REPORTING LEVELS FOR NONROUTINE OPERATING REPORTS

Analysis	Reporting Level (RL)				
	Water (pCi/l)	Airborne Particulate or Gases (pCi/M ³)	Fish (pCi/kg, wet)	Milk (pCi/l)	Broad Leaf Vegetation (pCi/Kg, wet)
H-3	2 x 10 ⁴ *				
Mn-54	1 x 10 ³		3 x 10 ⁴		
Fe-59	4 x 10 ²		1 x 10 ⁴		
Co-58	1 x 10 ³		3 x 10 ⁴		
Co-60	3 x 10 ²		1 x 10 ⁴		
Zn-65	3 x 10 ²		2 x 10 ⁴		
Zr-Nb-95	4 x 10 ²				
I-131	2	0.9		3	1 x 10 ²
Cs-134	30	10	1 x 10 ³	60	1 x 10 ³
Cs-137	50	20	2 x 10 ³	70	2 x 10 ³
Ba-La-140	2 x 10 ²			3 x 10 ²	

*For drinking water samples. This is 40 CFR Part 141 value.

6.0 CONDUCT OF TESTS AND INSPECTIONS
IN SUPPORT OF
WNP-2
RADIOACTIVE EFFLUENT AND RADIOLOGICAL
ENVIRONMENTAL MONITORING PROGRAMS

6.0 INTRODUCTION

NOTE: Technical Specification Amendment 98, in accordance with Generic Letter 89-01, relocated the following Limiting Conditions for Operations (LCO) from the WNP-2 Technical Specifications to the ODCM. To differentiate between Technical Specifications and ODCM programs, the following title changes were made:

Limiting Condition for Operation	-	Requirement for Operability
Applicability	-	Relevant Conditions
Action	-	Compensatory Measures
Surveillance, Surveillance Requirements	-	Periodic Tests and Inspections

Notations of periodic tests and inspections frequencies are defined in the requirements for operability frequency notation table (Table 6.0-1).

Applicable definitions of the ODCM, Licensee Controlled Specifications, and Technical Specifications (Section 1.0) shall be followed with respect to ODCM requirements for operability. Further, Section 3.0 of the Technical Specifications shall be followed in conforming to this section and LCO applicability statements 3.0.1, 3.0.2, 3.0.3, and 3.0.4 of the Technical Specifications are to be followed as applied in the text of the requirements for operability.

In cases where compensatory measures refer to Technical Specifications 3.0.3 and 3.0.4 as not being applicable, they refer to LCO applicability.

6.0.1 DEFINITIONS

The following definitions and definitions of Technical Specifications and Licensee Controlled Specifications apply to Chapter 6 of the ODCM. They are defined so that uniform interpretation of these requirements for operability may be achieved. The defined terms appear in capitalized type and shall be applicable throughout the ODCM.

6.0.1.1 MEMBER(S) OF THE PUBLIC

MEMBERS OF THE PUBLIC shall include all persons who are not occupationally associated with the plant. This category does not include employees of the utility, its contractors or vendors. Also excluded from this category are persons who enter the site to service equipment or to make deliveries. This category does include persons who use portions of the site for recreational, occupational or other purposes not associated with the plant.

6.0.1.2 OPERATIONAL CONDITION - CONDITION

See Technical Specification definition of MODE.

6.0.1.3 PURGE - PURGING

PURGE - PURGING shall be the controlled process of discharging air or gas from a confinement to maintain temperature, pressure, humidity, concentration or other operating condition, in such a manner that replacement air or gas is required to purify the confinement.

6.0.1.4 SITE BOUNDARY

The SITE BOUNDARY shall be as generally depicted in ODCM, Figure 3-1.

6.0.1.5 SOURCE CHECK

A SOURCE CHECK shall be the qualitative assessment of channel response when the channel sensor is exposed to a radioactive source.

6.0.1.6 UNRESTRICTED AREA

An UNRESTRICTED AREA shall be any area at or beyond the SITE BOUNDARY access to which is not controlled by the licensee for purposes of protection of individuals from exposure to radiation and radioactive materials, or any area within the site boundary used for residential quarters or for industrial, commercial, institutional, and/or recreational purposes.

6.0.1.7 VENTILATION EXHAUST TREATMENT SYSTEM

A VENTILATION EXHAUST TREATMENT SYSTEM shall be any system designed and installed to reduce gaseous radioiodine or radioactive material in particulate form in effluents by passing ventilation or vent exhaust gases through charcoal adsorbers and/or HEPA filters for the purpose of removing iodines or particulates from the gaseous exhaust stream prior to the release to the environment (such a system is not considered to have any effect on noble gas effluents). Engineered Safety Features (ESF) atmospheric cleanup systems are not considered to be VENTILATION EXHAUST TREATMENT SYSTEM components.

6.0.1.8 VENTING

VENTING shall be the controlled process of discharging air or gas from a confinement to maintain temperature, pressure, humidity, concentration, or other operating condition, in such a manner that replacement air or gas is not provided or required during VENTING. Vent, used in system names, does not imply a VENTING process.

TABLE 6.0-1

RFO FREQUENCY NOTATION

<u>NOTATION</u>	<u>FREQUENCY</u>
S	At least once per 12 hours.
D	At least once per 24 hours.
W	At least once per 7 days.
M	At least once per 31 days.
Q	At least once per 92 days.
SA	At least once per 184 days.
A	At least once per 366 days.
R	At least once per 18 months (550 days).
S/U	Prior to each reactor startup.
P	Prior to each radioactive release.
N.A.	Not applicable.

6.1 INSTRUMENTATION
IN SUPPORT OF
WNP-2
RADIOACTIVE EFFLUENT MONITORING
REQUIREMENT FOR OPERABILITY

6.1 INSTRUMENTATION

6.1.1 RADIOACTIVE LIQUID EFFLUENT MONITORING INSTRUMENTATION

CONTROLS

6.1.1.1 The radioactive liquid effluent monitoring instrumentation channels shown in Table 6.1.1.1-1 shall be OPERABLE with their alarm/trip setpoints set to ensure that the limits of Requirement for Operability 6.2.1.1 are not exceeded. The alarm/trip setpoints of these channels shall be determined and adjusted in accordance with the methodology and parameters described in the OFFSITE DOSE CALCULATION MANUAL (ODCM).

RELEVANT CONDITIONS: As shown in Table 6.1.1.1-1.

COMPENSATORY MEASURES:

- a. With a radioactive liquid effluent monitoring instrumentation channel alarm/trip setpoint less conservative than required by the above specification, immediately suspend the release of radioactive liquid effluents monitored by the affected channel or declare the channel inoperable.
- b. With less than the minimum number of radioactive liquid effluent monitoring instrumentation channels OPERABLE, take the COMPENSATORY MEASURES shown in Table 6.1.1.1-1. Restore the inoperable instrumentation to OPERABLE status within 30 days or, in lieu of a Licensee Event Report, explain why this inoperability was not corrected within the time specified in the next Radioactive Effluent Release Report.
- c. The provisions of Technical Specifications 3.0.3 and 3.0.4 are not applicable.

PERIODIC TESTS and INSPECTIONS

6.1.1.1.1 Each radioactive liquid effluent monitoring instrumentation channel shall be demonstrated OPERABLE by performance of the CHANNEL CHECK, SOURCE CHECK, CHANNEL CALIBRATION, and CHANNEL FUNCTIONAL TEST operations at the frequencies shown in Table 6.1.1.1.1-1.

TABLE 6.1.1.1-1

RADIOACTIVE LIQUID EFFLUENT MONITORING INSTRUMENTATION

<u>INSTRUMENT</u>	<u>MINIMUM CHANNELS OPERABLE</u>	<u>RELEVANT CONDITIONS</u>	<u>COMPENSATORY MEASURES</u>
1. GROSS RADIOACTIVITY MONITORS PROVIDING ALARM AND AUTOMATIC TERMINATION OF RELEASE			
a. Liquid Radwaste Effluent Line	1	(1)	100
b. Turbine Building Sump	1/Sump	(1)	101
2. GROSS RADIOACTIVITY MONITORS PROVIDING ALARM BUT NOT PROVIDING AUTOMATIC TERMINATION OF RELEASE			
a. Service Water System Effluent Line	1	At all times	101
b. RHR Service Water System Effluent Line	1/Loop	At all times	101
3. FLOW RATE MEASUREMENT DEVICES			
b. Liquid Radwaste Effluent Line	1	(1)	102
c. Plant Discharge-Blowdown Line	1	At all times	102
(1) When effluents are being discharged via this pathway.			

TABLE 6.1.1.1-1 (Continued)

COMPENSATORY MEASURES

- COMPENSATORY - With the number of channels OPERABLE less than required by the
MEASURE 100 Minimum Channels OPERABLE requirements, effluent releases
via this pathway may continue provided that prior to initiating a
release:
- a. At least two independent samples of the batch are analyzed
in accordance with Periodic Tests and Inspections 6.2.1.1.1
and 6.2.1.1.2 and
 - b. At least two technically qualified members of the facility
staff independently verify the release rate calculations and
the discharge valve lineup;
- COMPENSATORY - With the number of channels OPERABLE less than required by the
MEASURE 101 Minimum Channel OPERABLE requirement, effluent releases via
this pathway may continue for up to 30 days provided that, at least
once per 12 hours, grab samples are collected and are analyzed for
radioactivity (beta or gamma) at a limit of detection of at least 10^{-7}
microcurie/mL.
- COMPENSATORY - With the number of channels OPERABLE less than required by the
MEASURE 102 Minimum Channels OPERABLE requirement, effluent releases via
this pathway may continue for up to 30 days provided that the flow
rate is estimated at least once per 4 hours during actual releases.
Pump performance curves generated in place may be used to
estimate flow.

TABLE 6.1.1.1.1-1

RADIOACTIVE LIQUID EFFLUENT MONITORING INSTRUMENTATION PERIODIC TESTS AND INSPECTIONS

<u>INSTRUMENT</u>	<u>CHANNEL CHECK</u>	<u>SOURCE CHECK</u>	<u>CHANNEL CALIBRATION</u>	<u>CHANNEL FUNCTIONAL TEST</u>
1. GROSS RADIOACTIVITY MONITORS PROVIDING ALARM AND AUTOMATIC TERMINATION OF RELEASE				
a. Liquid Radwaste Effluent Line	D	P	R(3)	Q(1,2)
b. Turbine Building Sump	D	M	R(3)	Q(1,5)
2. GROSS RADIOACTIVITY MONITORS PROVIDING ALARM BUT NOT PROVIDING AUTOMATIC TERMINATION OF RELEASE				
a. Service Water System Effluent Line	D	M	R(3)	(5)
b. RHR Service Water System Effluent Line	D	M	R(3)	Q(2)
3. FLOW RATE MEASUREMENT DEVICES				
a. Liquid Radwaste Effluent Line	D(4)	N.A.	R	Q
b. Plant Discharge-Blowdown Line	D(4)	N.A.	R	Q

TABLE 6.1.1.1.1-1 (Continued)

TABLE NOTATIONS

- (1) The CHANNEL FUNCTIONAL TEST shall also demonstrate that automatic isolation of this pathway occurs if the:

Instrument indicates measured levels above the alarm setpoint.
- (2) The CHANNEL FUNCTIONAL TEST shall also demonstrate that control room alarm annunciation occurs if any of the following conditions exists:
 1. Instrument indicates measured levels above the alarm setpoint.
 2. High voltage abnormally low.
 3. Instrument indicates a downscale failure.
 4. Instrument controls not set in operate mode.
- (3) The initial CHANNEL CALIBRATION shall be performed using one or more reference standards certified by the National Institute of Science and Technology (NIST) or using standards that have been obtained from suppliers that participate in measurement assurance activities with NIST. These standards shall permit calibrating the system. For subsequent CHANNEL CALIBRATION, sources that have been related to the initial calibration shall be used.
- (4) CHANNEL CHECK shall consist of verifying indication of flow during periods of release. CHANNEL CHECK shall be made at least once per 24 hours when continuous, periodic, or batch releases are made.
- (5) The CHANNEL FUNCTIONAL TEST shall also demonstrate that control room alarm annunciation occurs if any of the following conditions exists:
 1. Instrument indicates measured levels above the alarm setpoint.
 2. High voltage abnormally low.
 3. Instrument indicates a downscale failure.

6.1 INSTRUMENTATION

6.1.2 RADIOACTIVE GASEOUS EFFLUENT MONITORING INSTRUMENTATION

CONTROLS

6.1.2 The radioactive gaseous effluent monitoring instrumentation channels shown in Table 6.1.2.1-1 shall be OPERABLE with their alarm/trip setpoints set to ensure that the limits of Requirements for Operability 6.2.2.1 are not exceeded. The alarm/trip setpoint of these channels shall be determined in accordance with the methodology and parameters described in the ODCM.

RELEVANT CONDITION: As shown in Table 6.1.2.1-1.

COMPENSATORY MEASURES:

- a. With a radioactive gaseous effluent monitoring instrumentation channel alarm/trip setpoint less conservative than required by the above specification, immediately initiate action to suspend the release of radioactive gaseous effluents monitored by the affected channel or change the setpoint so it is acceptably conservative or declare the channel inoperable.
- b. With less than the minimum number of radioactive gaseous effluent monitoring instrumentation channels OPERABLE, take the COMPENSATORY MEASURES shown in Table 6.1.2.1-1. If the inoperable instrumentation is not restored to OPERABLE status within 30 days, in lieu of a Licensee Event Report, explain why this inoperability was not corrected within the time specified in the next Radioactive Effluent Release Report.
- c. The provisions of Technical Specifications 3.0.3 and 3.0.4 are not applicable.

PERIODIC TESTS AND INSPECTIONS

6.1.2.1.1 Each radioactive gaseous effluent monitoring instrumentation channel shall be demonstrated OPERABLE by performance of the CHANNEL CHECK, SOURCE CHECK, CHANNEL CALIBRATION, and CHANNEL FUNCTIONAL TEST operations at the frequencies shown in Table 6.1.2.1.1-1.

TABLE 6.1.2.1.1-1

RADIOACTIVE GASEOUS EFFLUENT MONITORING INSTRUMENTATION

<u>INSTRUMENT</u>	<u>MINIMUM CHANNELS OPERABLE</u>	<u>RELEVANT CONDITIONS</u>	<u>COMPENSATORY MEASURES</u>
1. Main Condenser Offgas Post-Treatment Radiation Monitor			
a. Gross Gamma Detection Alarm and Automatic Isolation of the Offgas System Outlet and Drain Valves	1	(2)	110
2. Main Condenser Offgas Pre-Treatment Radiation Monitor	1	(2)	114
a. Gamma Sensitive Ion-Chamber Located Upstream of Holdup Line			
3. Main Plant Vent Release Monitor			
a. Low Range Noble Gas Monitor	1	(1)	110
b. Iodine Sampler	1	(1)	112
c. Particulate Sampler	1	(1)	112
d. Effluent System Flow Rate Monitor	1	(3)	113
e. Sampler Flow Rate Monitor	1	(3)	113

TABLE 6.1.2.1-1 (Continued)

RADIOACTIVE GASEOUS EFFLUENT MONITORING INSTRUMENTATION

<u>INSTRUMENT</u>	<u>MINIMUM CHANNELS OPERABLE</u>	<u>RELEVANT CONDITIONS</u>	<u>COMPENSATORY MEASURES</u>
4. Turbine Building Ventilation Exhaust Monitor			
a. Noble Gas Activity Monitor	1	(1)	110
1) Low Range			
2) Intermediate Range	1	(1)	111
b. Iodine Sampler	1	(1)	112
c. Particulate Sampler	1	(1)	112
d. Effluent System Flow Rate Monitor	1	(3)	113
e. Sampler Flow Rate Monitor	1	(3)	113
5. Radwaste Building Ventilation Exhaust			
a. Noble Gas Activity Monitor	1	(1)	110
1) Low Range			
2) Intermediate Range	1	(1)	111
b. Iodine Sampler	1	(1)	112
c. Particulate Sampler	1	(1)	112
d. Effluent System Flow Rate Measurement Device #	1	(3)	113
e. Sampler Flow Rate Monitor	1	(3)	113

TABLE 6.1.2.1-1 (Continued)
TABLE NOTATIONS

- (1) At all times.
- (2) During main condenser offgas treatment system operation.
- (3) During building exhaust system operation.
- # The System Flow Rate Measurement Device for the Radwaste Building ventilation is the exhaust fan. There are 3 fans; WEA-FN-1A, WEA-FN-1B and WEA-FN-1C. The system flow rate is based on fan motor current and the number of operating fans, and is displayed on the plant process computer.

COMPENSATORY MEASURES

- COMPENSATORY MEASURE 110 - With the number of channels OPERABLE less than required by the Minimum Channels OPERABLE requirement, collect grab samples^(a) at least once per 8 hours and analyze for noble gas gamma emitters within 24 hours.
- COMPENSATORY MEASURE 111 - With the number of channels OPERABLE less than required by the Minimum Channels OPERABLE requirement, collect grab samples at least once per 8 hours and analyze for noble gas gamma emitters within 24 hours. This sampling is not required if the Low Range Activity Monitor is OPERABLE and is not in ALARM.
- COMPENSATORY MEASURE 112 - With the number of channels OPERABLE less than required by the Minimum Channels OPERABLE requirement, within 4 hours after the channel has been declared inoperable establish auxiliary sampling equipment as required in Table 6.2.2.1.2-1^(a). In the event of inoperable auxiliary sampling equipment, sampling must be restored within 4 hours. If auxiliary sampling can not be performed, collect relevant information to provide an estimate of effluent releases, and report this event in the next Radioactive Effluent Release Report.
- COMPENSATORY MEASURE 113 - With the number of channels OPERABLE less than required by the Minimum Channels OPERABLE requirement, estimate the flow rate at least once per 4 hours.
- COMPENSATORY MEASURE 114 - With the number of channels operable less than required by the Minimum Channels OPERABLE requirement, gases from the main condenser offgas treatment system may be released to the environment for up to 72 hours provided:
 - a. The offgas treatment system is not bypassed, and
 - b. The offgas post-treatment monitor used in a pretreatment function shall be OPERABLE, or install a temporary replacement ionization chamber for the pre-treatment monitor.If the conditions of a. and b. can not be met, be in HOT STANDBY within the following 12 hours.

- (a) When building exhaust is secured, collect building ambient air samples.

TABLE 6.1.2.1.1-1

RADIOACTIVE GASEOUS EFFLUENT MONITORING INSTRUMENTATION PERIODIC TESTS AND INSPECTIONS REQUIREMENTS

<u>INSTRUMENT</u>	<u>CHANNEL CHECK</u>	<u>SOURCE CHECK</u>	<u>CHANNEL CALIBRATION</u>	<u>CHANNEL FUNCTIONAL TEST</u>	<u>MODES IN WHICH PERIODIC TESTS AND INSPECTIONS ARE REQUIRED</u>
1. Main Condenser Offgas Post-Treatment Radiation Monitor	D	D	R(2)	Q(1)	**
a. Gross gamma detector alarm and automatic isolation of the offgas system outlet and drain valves					
2. Main Condenser Offgas Pre-Treatment Radiation Monitor	D	M	R(2)	Q(1)	**
a. Gamma sensitive ion chamber located upstream of holdup line					
3. Main Plant Release Monitor	D	M	R(2)	Q(1)	*
a. Low Range Activity Monitor					
b. Iodine Sampler	W	N.A.	N.A.	N.A.	*
c. Particulate Sampler	W	N.A.	N.A.	N.A.	*
d. Effluent System Flow Rate Monitor	D	N.A.	R	Q	*
e. Sampler Flow Rate Monitor	D	N.A.	R	Q	*

TABLE 6.1.2.1.1-1 (Continued)

RADIOACTIVE GASEOUS EFFLUENT MONITORING INSTRUMENTATION PERIODIC TESTS AND INSPECTIONS REQUIREMENTS

<u>INSTRUMENT</u>	<u>CHANNEL CHECK</u>	<u>SOURCE CHECK</u>	<u>CHANNEL CALIBRATION</u>	<u>CHANNEL FUNCTIONAL TEST</u>	<u>MODES IN WHICH PERIODIC TESTS AND INSPECTIONS ARE REQUIRED</u>
4. Turbine Building Ventilation Exhaust Monitor					
a. Noble Gas Activity Monitor					
1) Low Range	D	M	R(2)	Q(1)	*
2) Intermediate Range	D	M	R(2)	Q(6)	*
b. Iodine Sampler	W	N.A.	N.A.	N.A.	*
c. Particulate Sampler	W	N.A.	N.A.	N.A.	*
d. Effluent System Flow Rate Monitor	D	N.A.	R	Q	*
e. Sampler Flow Rate Monitor	D	N.A.	R	Q	*
5. Radwaste Building Ventilation Exhaust					
a. Noble Gas Activity Monitor					
1) Low Range	D	M	R(2)	Q(1)	*
2) Intermediate Range	D	M	R(2)	Q(6)	*
b. Iodine Sampler	W	N.A.	N.A.	N.A.	*
c. Particulate Sampler	W	N.A.	N.A.	N.A.	*
d. Effluent System Flow Rate Monitor	D(3)	N.A.	R(5)	Q(4)	*
e. Sampler Flow Rate Monitor	D	N.A.	R	Q	*

TABLE 6.1.2.1.1-1 (Continued)

TABLE NOTATIONS

* At all times.

** During main condenser offgas treatment system operation

- (1) The CHANNEL FUNCTIONAL TEST shall also demonstrate that control room alarm annunciation occurs if any of the following conditions exist:
 - a. Instrument indicates measured levels above the alarm setpoint.
 - b. Circuit failure.
- (2) The initial CHANNEL CALIBRATION shall be performed using one or more reference radioactive standards traceable to the NATIONAL INSTITUTE OF SCIENCE AND TECHNOLOGY (NIST) or using standards that have been obtained from suppliers that participate in measurement assurance activities with NIST. These standards shall permit calibrating the system over its intended range of energy and measurement range. Subsequent CHANNEL CALIBRATION shall be performed using the initial radioactive standards or other standards of equivalent quality or radioactive sources that have been related to the initial calibration.
- (3) The CHANNEL CHECK shall be performed by comparing a computer reading or power signal comparing each fan's local amperage reading with preestablished baseline values.
- (4) The CHANNEL FUNCTIONAL TEST shall be performed by measurement of the phase currents for each fan.
- (5) The CHANNEL CALIBRATION shall be performed by using a flow measurement device to determine the fan current to flow relationship.
- (6) For the CHANNEL FUNCTIONAL TEST on the intermediate range noble gas activity monitors, demonstrate that circuit failures or instrument controls when set in the OFF position produce control room alarm annunciation.

6.2 REQUIREMENT FOR OPERABILITY
IN
SUPPORT
OF
RADIOACTIVE EFFLUENT MONITORING
PROGRAMS

6.2 RADIOACTIVE EFFLUENTS

6.2.1 LIQUID EFFLUENTS

6.2.1.1 CONCENTRATION

REQUIREMENTS FOR OPERABILITY

6.2.1.1 The concentration of radioactive material released in liquid effluents to UNRESTRICTED AREAS (see ODCM Figure 3-1) shall be limited to the concentrations specified in 10 CFR Part 20, Appendix B, Table II, Column 2 for radionuclides other than dissolved or entrained noble gases. For dissolved or entrained noble gases, the concentration shall be limited to 2×10^{-4} microcurie/ml total activity.

RELEVANT CONDITIONS: At all times.

COMPENSATORY MEASURES:

With the concentration of radioactive material released in liquid effluents to UNRESTRICTED AREAS exceeding the above limits, immediately restore the concentration to the above limits.

PERIODIC TESTS AND INSPECTIONS

6.2.1.1.1 Radioactive liquid wastes shall be sampled and analyzed according to the sampling and analysis program of Table 6.2.1.1.1-1.

6.2.1.1.2 The results of the radioactivity analyses shall be used in accordance with the methodology and parameters in the ODCM to assure that the concentrations at the point of release are maintained within the limits of Requirement for Operability 6.2.1.1.

TABLE 6.2.1.1.1-1

RADIOACTIVE LIQUID WASTE SAMPLING AND ANALYSIS PROGRAM

LIQUID RELEASE TYPE	SAMPLING FREQUENCY	MINIMUM ANALYSIS FREQUENCY	TYPE OF ACTIVITY ANALYSIS	LOWER LIMIT OF DETECTION (LLD) ^a (μ Ci/ml)
A. Batch Waste Release Tanks	P Each Batch	P Each Batch	Principal Gamma Emitters ^c	5×10^{-7}
			I-131	1×10^{-6}
	P One Batch/M	M	Dissolved and Entrained Gases (Gamma Emitters)	1×10^{-5}
			P Each Batch	M Composite ^d
	Gross Alpha	1×10^{-7}		
	P Each Batch	Q Composite ^d	Sr-89, Sr-90	5×10^{-8}
Fe-55			1×10^{-6}	

TABLE 6.2.1.1.1-1 (Continued)

TABLE NOTATIONS

* The LLD is defined, for purposes of these specifications, as the smallest concentration of radioactive material in a sample that will yield a net count, above system background, that will be detected with 95% probability with only 5% probability of falsely concluding that a blank observation represents a "real" signal.

For a particular measurement system, which may include radiochemical separation:

$$LLD = \frac{4.66s_b}{E \cdot V \cdot 2.22 \times 10^6 \cdot Y \cdot \exp(-\lambda \Delta t)}$$

Where:

LLD is the "a priori" lower limit of detection as defined above, as microcuries per unit mass or volume,

s_b is the standard deviation of the background counting rate or of the counting rate of a blank sample as appropriate, as counts per minute,

E is the counting efficiency as counts per disintegration,

V is the sample size in units of mass or volume,

2.22×10^6 is the number of disintegrations per minute per microcurie,

Y is the fractional radiochemical yield, when applicable,

λ is the radioactive decay constant for the particular radionuclide, and

Δt for plant effluents is the elapsed time between the midpoint of sample collection and time of counting.

Typical values of E, V, Y, and Δt should be used in the calculation.

It should be recognized that the LLD is defined as an a priori (before the fact) limit representing the capability of a measurement system and not as an a posteriori (after the fact) limit for a particular measurement.

TABLE 6.2.1.1.1-1 (Continued)

TABLE NOTATIONS

^b A batch release is the discharge of liquid wastes of a discrete volume.

Prior to sampling for analyses, each batch shall be isolated, and then thoroughly mixed by a method described in the ODCM to assure representative sampling.

^c The principal gamma emitters for which the LLD specification applies include the following radionuclides: Mn-54, Fe-59, Co-58, Co-60, Zn-65, Mo-99, Cs-134, Cs-137, Ce-141, and Ce-144. This list does not mean that only these nuclides are to be considered. Other gamma peaks that are identifiable, together with those of the above nuclides, shall also be analyzed and reported in the Radioactive Effluent Release Report, ODCM 6.4.2.

^d A composite sample is one in which the quantity of liquid sampled is proportional to the quantity of liquid waste discharged and in which the method of sampling employed results in a specimen that is representative of the liquids released. This may be accomplished through composites of grab samples obtained prior to discharge after the tanks have been recirculated.

6.2 RADIOACTIVE EFFLUENTS

6.2.1 LIQUID EFFLUENTS

6.2.1.2 DOSE

REQUIREMENT FOR OPERABILITY

6.2.1.2 The dose or dose commitment to a MEMBER OF THE PUBLIC from radioactive materials in liquid effluents released to UNRESTRICTED AREAS (see ODCM Figure 3-1) shall be limited:

- a. During any calendar quarter to less than or equal to 1.5 mrem to the total body and to less than or equal to 5 mrem to any organ, and
- b. During any calendar year to less than or equal to 3 mrem to the total body and to less than or equal to 10 mrem to any organ.

RELEVANT CONDITIONS: At all times.

COMPENSATORY MEASURES:

- a. With the calculated dose from the release of radioactive materials in liquid effluents exceeding any of the above limits, in lieu of a Licensee Event Report, prepare and submit to the Commission within 30 days, pursuant to 10 CFR 50, Appendix I, Section IV.A, a Special Report that identifies the cause(s) for exceeding the limit(s) and defines the corrective actions that have been taken to reduce the releases and the proposed corrective action to be taken to assure that subsequent releases will be in compliance with the above limits. This Special Report shall also include (1) the results of radiological analyses of the drinking water source and (2) the radiological impact on finished drinking water supplies with regard to the requirements of 40 CFR Part 141.
- b. The provisions of Technical Specifications 3.0.3 and 3.0.4 are not applicable.

PERIODIC TESTS AND INSPECTIONS

6.2.1.2.1 Cumulative dose contributions from liquid effluents for the current calendar quarter and the current calendar year shall be determined in accordance with the methodology and parameters in the ODCM at least once per 31 days.

6.2 RADIOACTIVE EFFLUENTS

6.2.1 LIQUID EFFLUENTS

6.2.1.3 LIQUID RADWASTE TREATMENT SYSTEM

REQUIREMENT FOR OPERABILITY

6.2.1.3 The liquid radwaste treatment system shall be OPERABLE. The appropriate portions of the system shall be used to reduce the releases of radioactivity when the projected doses due to the liquid effluent, from each reactor unit, to UNRESTRICTED AREAS (see ODCM Figure 3-1) would exceed 0.06 mrem to the total body or 0.2 mrem to any organ in a 31-day period.

RELEVANT CONDITIONS: At all times.

COMPENSATORY MEASURES:

- a. With radioactive liquid waste being discharged without treatment and in excess of the above limits and any portion of the liquid radwaste treatment system not in operation, in lieu of a Licensee Event Report, prepare and submit to the Commission within 30 days pursuant to 10 CFR 50, Appendix I, Section IV.A, a Special Report that includes the following information:
 1. Explanation of why liquid radwaste was being discharged without treatment, identification of any inoperable equipment or subsystems, and the reason for the inoperability,
 2. Action(s) taken to restore the inoperable equipment to OPERABLE status, and
 3. Summary description of actions(s) taken to prevent a recurrence.
- b. The provisions of Technical Specifications 3.0.3 and 3.0.4 are not applicable.

PERIODIC TESTS AND INSPECTIONS

6.2.1.3.1 Doses due to liquid releases from each reactor unit to UNRESTRICTED AREAS shall be projected at least once per 31 days in accordance with the methodology and parameters in the ODCM.

6.2.1.3.2 The installed liquid radwaste treatment system shall be demonstrated OPERABLE by meeting Requirement for Operability 6.2.1.1 and 6.2.1.2.

6.2 RADIOACTIVE EFFLUENTS

6.2.2 GASEOUS EFFLUENTS

6.2.2.1 DOSE RATE

REQUIREMENT FOR OPERABILITY

6.2.2.1 The dose rate due to radioactive materials released in gaseous effluents from the site to areas at and beyond the SITE BOUNDARY (see ODCM Figure 3-1) shall be limited to the following:

- a. For noble gases: Less than or equal to 500 mrem/yr to the total body and less than or equal to 3000 mrem/yr to the skin, and
- b. For iodine-131, for iodine-133, for tritium, and for all radionuclides in particulate form with half-lives greater than 8 days: Less than or equal to 1500 mrem/yr to any organ.

RELEVANT CONDITIONS: At all times.

COMPENSATORY MEASURES:

With the dose rate exceeding the above limits, immediately restore the release rate to within the above limit(s).

PERIODIC TESTS AND INSPECTIONS

6.2.2.1.1 The dose rate due to noble gases in gaseous effluents shall be determined to be within the above limits in accordance with the methodology and parameters in the ODCM.

6.2.2.1.2 The dose rate due to iodine-131, iodine-133, tritium, and all radionuclides in particulate form with half-lives greater than 8 days in gaseous effluents shall be determined to be within the above limits in accordance with the methodology and parameters in the ODCM by obtaining representative samples and performing analyses in accordance with the sampling and analysis program specified in Table 6.2.2.1.2-1.

TABLE 6.2.2.1.2-1
RADIOACTIVE GASEOUS WASTE SAMPLING AND ANALYSIS PROGRAM

GASEOUS RELEASE TYPE	SAMPLING FREQUENCY	MINIMUM ANALYSIS FREQUENCY	TYPE OF ACTIVITY ANALYSIS	LOWER LIMIT OF DETECTION (LLD) ^a ($\mu\text{Ci}/\text{ml}$)
A. Primary Containment PURGE and VENT	p ^{b,h} Each PURGE and VENT	p ^{b,h,l} Each PURGE and VENT	Principal Gamma Emitters ^f	1×10^{-4}
	Grab Sample	M	H-3	1×10^{-6}
B. Main Plant Vent	M ^{b,d} Grab Sample	M ^{b,l}	Principal Gamma Emitters ^f	1×10^{-4}
		W	H-3	1×10^{-6}
C. Turbine Building Vents and Radwaste Building Vents	M Grab Sample	M	Principal Gamma Emitters ^f	1×10^{-4}
			H-3	1×10^{-6}
D. All Release Types as listed in A, B, and C above	Continuous ^a	W ^{c,g,l} Charcoal Sample	I-131 I-131	1×10^{-12} 1×10^{-10}
	Continuous ^a	W ^{c,g,l} Particulate Sample	Principal Gamma Emitters ^f	1×10^{-11}
	Continuous ^a M	Composite Particulate Sample	Gross Alpha	1×10^{-11}
	Continuous ^a Q	Composite Particulate Sample	Gross Alpha	1×10^{-11}
	Continuous ^a	Noble Gas Monitor	Noble Gases Gross Beta or Gamma	1×10^{-6} (Xe-133 equivalent)

TABLE 6.2.2.1.2-1 (Continued)

TABLE NOTATIONS

^aThe LLD is defined, for purposes of these specifications, as the smallest concentration of radioactive material in a sample that will yield a net count, above system background, that will be detected with 95% probability with only 5% probability of falsely concluding that a blank observation represents a "real" signal.

For a particular measurement system, which may include radiochemical separation:

$$LLD = \frac{4.66s_b}{E \cdot V \cdot 2.22 \times 10^6 \cdot Y \cdot \exp(-\lambda \Delta t)}$$

Where:

LLD is the "a priori" lower limit of detection as defined above, as microcuries per unit mass or volume,

s_b is the standard deviation of the background counting rate or of the counting rate of a blank sample as appropriate, as counts per minute,

E is the counting efficiency, as counts per disintegration,

V is the sample size in units of mass or volume,

2.22×10^6 is the number of disintegrations per minute per microcurie,

Y is the fractional radiochemical yield, when applicable,

λ is the radioactive decay constant for the particular radionuclide, and

Δt for plant effluents is the elapsed time between the midpoint of sample collection and time of counting.

Typical values of E, V, Y, and Δt should be used in the calculation.

It should be recognized that the LLD is defined as an a priori (before the fact) limit representing the capability of a measurement system and not as an a posteriori (after the fact) limit for a particular measurement.

TABLE 6.2.2.1.2-1 (Continued)

TABLE NOTATIONS

- b. Sampling and analysis shall also be performed following startup or shutdown.
- c. Sampling shall also be performed at least once per 24 hours for at least 7 days following each shutdown or startup, and analyses shall be completed within 48 hours of changing. When samples collected for 24 hours are analyzed, the corresponding LLDs may be increased by a factor of 10.

This requirement does not apply if:

- (1) a. Analysis shows that the DOSE EQUIVALENT 1-131 concentration in the primary coolant is less than or equal to $1.0E-03 \mu\text{i}/\text{cc}$.
or
b. When the DOSE EQUIVALENT 1-131 concentration in the primary coolant is greater than $1.0E-03 \mu\text{Ci}/\text{cc}$, it has not increased more than a factor of 3;
and
- (2) a. When the noble gas monitor is less than or equal to 2.0% of the setpoint determined in accordance with ODCM Section 3.6.
or
b. When the noble gas monitor is greater than 2.0% of its setpoint, it shows that effluent activity has not increased more than a factor of 3.
- d. Tritium grab samples shall be taken at least once per 7 days from the main plant vent stack to determine tritium releases in the ventilation exhaust from the spent fuel pool area whenever spent fuel is in the spent fuel pool.
- e. The ratio of the sample flow rate to the sampled stream flow rate shall be known for the time period covered by each dose or dose rate calculation made in accordance with Requirement for Operability 6.2.2.1, 6.2.2.2 and 6.2.2.3.
- f. The principal gamma emitters for which the LLD specification applies include the following radionuclides: Kr-87, Kr-88, Xe-133, Xe-133m, Xe-135, and Xe-138 in noble gas releases and Mn-54, Fe-59, Co-58, Co-60, Zn-65, Mo-99, I-131, Cs-134, Cs-137, Ce-141 and Ce-144 in iodine and particulate releases. This list does not mean that only these nuclides are to be considered. Other gamma peaks that are identifiable, together with those of the above nuclides, shall also be analyzed and reported in the Radioactive Effluent Release Report.

TABLE 6.2.2.1.2-1 (Continued)

TABLE NOTATIONS

- g. Analyses shall be completed within 48 hours after changing, or after removal from sampler.
- h. Sampling and analysis is not required for primary containment VENTING or PURGING when the path is through the 2-inch exhaust valves and the standby gas treatment system, and the containment noble gas monitoring instrumentation indicates less than the alarm setpoint.
- i. Sampling and analysis shall also be performed following a THERMAL POWER change exceeding 15% of RATED THERMAL POWER within a 1-hour period, when the noble gas release rate, as indicated by the main condenser offgas pretreatment monitor, is greater than 15,000 $\mu\text{Ci}/\text{sec}$.
- j. Sampling shall also be performed at least once per 24 hours for at least seven days following each THERMAL POWER change exceeding 15% of RATED THERMAL POWER in one hour when the noble gas release rate, as indicated by the main condenser offgas pretreatment monitor, is greater than 15,000 $\mu\text{Ci}/\text{sec}$. Analyses shall be completed within 48 hours of changing. When samples collected for 24 hours are analyzed, the corresponding LLDs may be increased by a factor of 10.

This requirement does not apply if:

- (1) a. Analysis shows that the DOSE EQUIVALENT 1-131 concentration in the primary coolant is less than or equal to $1.0\text{E}-03 \mu\text{i}/\text{cc}$.
or
b. When the DOSE EQUIVALENT 1-131 concentration in the primary coolant is greater than $1.0\text{E}-03 \mu\text{Ci}/\text{cc}$, it has not increased more than a factor of 3;
and
- (2) a. When the noble gas monitor is less than or equal to 2.0% of the setpoint determined in accordance with ODCM Section 3.6.
or
b. When the noble gas monitor is greater than 2.0% of its setpoint, it shows that effluent activity has not increased more than a factor of 3.

6.2 RADIOACTIVE EFFLUENTS

6.2.2 GASEOUS EFFLUENTS

6.2.2.2 DOSE - NOBLE GASES

REQUIREMENT FOR OPERABILITY

6.2.2.2 The air dose due to noble gases released in gaseous effluents, from each reactor unit, to areas at and beyond the SITE BOUNDARY (see ODCM Figure 3-1) shall be limited to the following:

- a. During any calendar quarter: Less than or equal to 5 mrad for gamma radiation and less than or equal to 10 mrad for beta radiation and,
- b. During any calendar year: Less than or equal to 10 mrad for gamma radiation and less than or equal to 20 mrad for beta radiation.

RELEVANT CONDITIONS: At all times.

COMPENSATORY MEASURES:

- a. With the calculated air dose from radioactive noble gases in gaseous effluents exceeding any of the above limits, in lieu of a Licensee Event Report, prepare and submit to the Commission within 30 days, pursuant to 10 CFR 50, Appendix I, Section IV.A, a Special Report that identifies the cause(s) for exceeding the limit(s) and defines the corrective actions that have been taken to reduce the releases and the proposed corrective actions to be taken to assure that subsequent releases will be in compliance with the above limits.
- b. The provisions of Technical Specifications 3.0.3 and 3.0.4 are not applicable.

PERIODIC TESTS AND INSPECTIONS

6.2.2.2.1 Cumulative dose contributions for the current calendar quarter and current calendar year for noble gases shall be determined in accordance with the methodology and parameters in the ODCM at least once per 31 days.

6.2 RADIOACTIVE EFFLUENTS

6.2.2 GASEOUS EFFLUENTS

6.2.2.3 DOSE - IODINE-131, IODINE-133, TRITIUM, AND RADIONUCLIDES IN PARTICULATE FORM

REQUIREMENT FOR OPERABILITY

6.2.2.3 The dose to a MEMBER OF THE PUBLIC from iodine-131, iodine-133, tritium, and all radionuclides in particulate form with half-lives greater than 8 days in gaseous effluents released, from each reactor unit, to areas at and beyond the SITE BOUNDARY (see ODCM Figure 3-1) shall be limited to the following:

- a. During any calendar quarter: Less than or equal to 7.5 mrem to any organ and,
- b. During any calendar year: Less than or equal to 15 mrem to any organ.

RELEVANT CONDITIONS: At all times.

COMPENSATORY MEASURES:

- a. With the calculated dose from the release of iodine-131, iodine-133, tritium, and radionuclides in particulate form with half-lives greater than 8 days, in gaseous effluents exceeding any of the above limits, in lieu of a Licensee Event Report, prepare and submit to the Commission within 30 days, pursuant to 10 CFR 50, Appendix I, Section IV.A, a Special Report that identifies the cause(s) for exceeding the limit and defines the corrective actions that have been taken to reduce the releases and the proposed corrective actions to be taken to assure that subsequent releases will be in compliance with the above limits.
- b. The provisions of Technical Specifications 3.0.3 and 3.0.4 are not applicable.

PERIODIC TESTS AND INSPECTIONS

6.2.2.3.1 Cumulative dose contributions for the current calendar quarter and current calendar year for iodine-131, iodine-133, tritium, and radionuclides in particulate form with half-lives greater than 8 days shall be determined in accordance with the methodology and parameters in the ODCM at least once per 31 days.

6.2 RADIOACTIVE EFFLUENTS

6.2.2 GASEOUS EFFLUENT

6.2.2.4 GASEOUS OFFGAS RADWASTE TREATMENT SYSTEM

REQUIREMENT FOR OPERABILITY

6.2.2.4 The GASEOUS OFFGAS RADWASTE TREATMENT SYSTEM* shall be in operation in either the normal or charcoal bypass mode. The charcoal bypass mode shall not be used unless the offgas post-treatment radiation monitor is OPERABLE as specified in Table 6.1.2.1-1.

RELEVANT CONDITIONS: Whenever the main condenser steam jet air ejector (evacuation) system is in operation.

COMPENSATORY MEASURES:

- a. With the GASEOUS OFFGAS RADWASTE TREATMENT SYSTEM not used in the normal mode for more than 7 days, in lieu of a Licensee Event Report, prepare and submit to the Commission within 30 days, pursuant to 10 CFR 50, Appendix I, Section IV.A, a Special Report which includes the following information:
 1. Identification of the inoperable equipment or subsystems and the reason for inoperability,
 2. Action(s) taken to restore the inoperable equipment to OPERABLE status, and
 3. Summary description of action(s) taken to prevent a recurrence.
- b. The provisions of Technical Specifications 3.0.3 and 3.0.4 are not applicable.

PERIODIC TESTS AND INSPECTIONS

6.2.2.4.1 The GASEOUS OFFGAS RADWASTE TREATMENT SYSTEM shall be verified to be in operation in either the normal or charcoal bypass mode at least once per 7 days whenever the main condenser steam jet air ejector (evacuation) system is in operation.

* A GASEOUS OFFGAS RADWASTE TREATMENT SYSTEM shall be any system designed and installed to reduce radioactive gaseous effluents by collecting primary coolant system offgases from the primary system and providing for delay or holdup for the purpose of reducing the total radioactivity prior to release to the environment.

6.2 RADIOACTIVE EFFLUENTS

6.2.2 GASEOUS EFFLUENTS

6.2.2.5 VENTILATION EXHAUST TREATMENT SYSTEM

REQUIREMENT FOR OPERABILITY

6.2.2.5 The appropriate portions of the VENTILATION EXHAUST TREATMENT SYSTEM shall be OPERABLE and shall be used to reduce radioactive materials in gaseous waste prior to their discharge when the projected doses due to gaseous effluent releases from each reactor unit to areas at and beyond the SITE BOUNDARY (see ODCM Figure 3-1) when averaged over 31 days would exceed 0.3 mrem to any organ in a 31-day period.

RELEVANT CONDITIONS: At all times.

COMPENSATORY MEASURES:

- a. With the VENTILATION EXHAUST TREATMENT SYSTEM inoperable for more than 31 days, or with gaseous waste being discharged without treatment and in excess of the above limits, in lieu of a Licensee Event Report, prepare and submit to the Commission within 10 days, pursuant to 10 CFR 50, Appendix I, Section IV.A, a Special Report which includes the following information:
 1. Identification of the inoperable equipment or subsystems, and the reason for the inoperability,
 2. Action(s) taken to restore the inoperable equipment to OPERABLE status, and
 3. Summary description of action(s) taken to prevent a recurrence.
- b. The provisions of Technical Specifications 3.0.3 and 3.0.4 are not applicable.

PERIODIC TESTS AND INSPECTIONS

6.2.2.5.1 Doses due to gaseous release to areas at and beyond the SITE BOUNDARY shall be projected at least once per 31 days in accordance with the methodology and parameters in the ODCM.

6.2.2.5.2 The VENTILATION EXHAUST TREATMENT SYSTEM shall be demonstrated OPERABLE by operating the VENTILATION EXHAUST TREATMENT SYSTEM equipment for at least 10 minutes, at least once per 92 days unless the appropriate system has been utilized to process radioactive gaseous effluents during the previous 92 days.

6.2.2 RADIOACTIVE EFFLUENTS

6.2.2 GASEOUS EFFLUENTS

6.2.2.6 VENTING OR PURGING

REQUIREMENT FOR OPERABILITY

6.2.2.6 VENTING or PURGING of the Mark II containment shall be through the standby gas treatment system or the primary containment vent and purge system. The first 24 hours of any vent or purge operation shall be through one standby gas treatment system.

RELEVANT CONDITIONS: All containment vents and purges in Mode 1, 2, or 3, and when de-inerting.

COMPENSATORY MEASURES:

- a. With the requirements of the above specification not satisfied, suspend all VENTING and PURGING of the containment.
- b. The provisions of Technical Specifications 3.0.3 and 3.0.4 are not applicable.

PERIODIC TESTS AND INSPECTIONS

6.2.2.6.1 The containment shall be determined to be aligned for VENTING or PURGING through the standby gas treatment system or the primary containment vent and purge system within 4 hours prior to start of and at least once per 12 hours during VENTING or PURGING of the drywell.

6.2.2.6.2 When VENTING or PURGING through the 2-inch exhaust lines through the standby gas treatment system, the standby gas treatment system train used for VENTING or PURGING shall be functional for filtration of the primary containment effluent.

6.2.2.6.3 In Modes 1, 2, or 3, when VENTING or PURGING through the 24-inch or 30-inch exhaust lines through the standby gas treatment system, the standby gas treatment system train NOT used for PURGING or VENTING shall be OPERABLE, and the standby gas treatment system train used for VENTING or PURGING shall be functional for filtration of the primary containment effluent.

6.2.2.6.4 In Mode 4 when de-inerting through the 24-inch or 30-inch exhaust lines through the standby gas treatment system, the standby gas treatment system train used for VENTING or PURGING shall be functional for filtration of the primary containment effluent.

PERIODIC TESTS AND INSPECTIONS (Continued)

6.2.2.6.5 When VENTING or PURGING in Modes 1, 2, or 3, only one of the standby gas treatment system trains may be used.

6.2.2.6.6 When VENTING or PURGING, the containment atmosphere shall be sampled and analyzed per Table 6.2.2.1.2-1 of Requirements for Operability 6.2.2.1 within 8 hours prior to the start of the VENT or PURGE. If the Main Plant Vent effluent monitor is not operable, sampling and analysis shall be completed at least once per 12 hours during the VENT or PURGE.

6.2 RADIOACTIVE EFFLUENTS

6.2.3 SOLID RADIOACTIVE WASTE

6.2.3.1 SOLID RADIOACTIVE WASTE

REQUIREMENT FOR OPERABILITY

6.2.3.1 Radioactive wastes shall be SOLIDIFIED or dewatered in accordance with the PROCESS CONTROL PROGRAM to meet shipping and transportation requirements during transit, and disposal site requirements when received at the disposal site.

RELEVANT CONDITIONS: At all times.

COMPENSATORY MEASURES:

- a. With SOLIDIFICATION* or dewatering not meeting disposal site and shipping and transportation requirements, suspend shipment of the inadequately processed wastes and correct the PROCESS CONTROL PROGRAM, the procedures and/or the solid waste system as necessary to prevent recurrence.
- b. With SOLIDIFICATION or dewatering not performed in accordance with the PROCESS CONTROL PROGRAM, (1) test the improperly processed waste in each container to ensure that it meets burial ground and shipping requirements and (2) take appropriate administrative action to prevent recurrence.
- c. The provisions of Technical Specifications 3.0.3 and 3.0.4 are not applicable.

PERIODIC TESTS AND INSPECTIONS

6.2.3.1.1 SOLIDIFICATION of at least one representative test specimen from at least every tenth batch of each type of wet radioactive wastes (e.g., filter sludges, spent resins, evaporator bottoms, boric acid solutions, and sodium sulfate solutions) shall be verified in accordance with the PROCESS CONTROL PROGRAM.

- a. If any test specimen fails to verify SOLIDIFICATION, the SOLIDIFICATION of the batch under test shall be suspended until such time as additional test specimens can be obtained, alternative SOLIDIFICATION parameters can be determined in accordance with the PROCESS CONTROL PROGRAM, and a subsequent test verifies SOLIDIFICATION. SOLIDIFICATION of the batch may then be resumed using the alternative SOLIDIFICATION parameters determined by the PROCESS CONTROL PROGRAM.

PERIODIC TESTS AND INSPECTIONS (Continued)

- * **SOLIDIFICATION** shall be the conversion of radioactive wastes from liquid systems to a homogeneous (uniformly distributed), monolithic, immobilized solid with definite volume and shape, bounded by a stable surface of distinct outline on all sides (free-standing).
- b. If the initial test specimen from a batch of waste fails to verify **SOLIDIFICATION**, the **PROCESS CONTROL PROGRAM** shall provide for the collection and testing of representative test specimens from each consecutive batch of the same type of wet waste until at least three consecutive initial test specimens demonstrate **SOLIDIFICATION**. The **PROCESS CONTROL PROGRAM** shall be modified as required, as provided in FSAR 11.4.3, to assure **SOLIDIFICATION** of subsequent batches of waste.
- c. With the installed equipment incapable of meeting Requirement for Operability 6.2.3.1 or declared inoperable, restore the equipment to **OPERABLE** status or provide for contract capability to process wastes as necessary to satisfy all applicable transportation and disposal requirements.

6.2 RADIOACTIVE EFFLUENTS

6.2.4 TOTAL DOSE

REQUIREMENT FOR OPERABILITY

6.2.4.1 The annual (calendar year) dose or dose commitment to any MEMBER OF THE PUBLIC, due to releases of radioactivity and radiation, from uranium fuel cycle sources shall be limited to less than or equal to 25 mremS to the total body or any organ, except the thyroid, which shall be limited to less than or equal to 75 mremS.

RELEVANT CONDITIONS: At all times.

COMPENSATORY MEASURES:

- a. With the calculated doses from the release of radioactive materials in liquid or gaseous effluents exceeding twice the limits of Requirement for Operability 6.2.1.2.a, 6.2.1.2.b, 6.2.2.2.a, 6.2.2.2.b, 6.2.2.3.a, or 6.2.2.3.b, calculations shall be made including direct radiation contributions from the reactor units and from outside storage tanks to determine whether the above limits of Requirement for Operability 6.2.4.1 have been exceeded. If such is the case, in lieu of a Licensee Event Report, prepare and submit to the Commission within 30 days, pursuant to 10 CFR 50, Appendix I, Section IV.A, a Special Report that defines the corrective action to be taken to reduce subsequent releases to prevent recurrence of exceeding the above limits and includes the schedule for achieving conformance with the above limits. This Special Report, as defined in 10 CFR 20.2203.A, shall include an analysis that estimates the radiation exposure (dose) to a MEMBER OF THE PUBLIC from uranium fuel cycle sources, including all effluent pathways and direct radiation, for the calendar year that includes the release(s) covered by this report. It shall also describe levels of radiation and concentrations of radioactive material involved, and the cause of the exposure levels or concentrations. If the estimated dose(s) exceeds the above limits, and if the release condition resulting in violation of 40 CFR Part 190 has not already been corrected, the Special Report shall include a request for a variance in accordance with the provisions of 40 CFR Part 190. Submittal of the report is considered a timely request, and a variance is granted until staff action on the request is complete.
- b. The provisions of Technical Specifications 3.0.3 and 3.0.4 are not applicable.

6.2 RADIOACTIVE EFFLUENTS

6.2.4 TOTAL DOSE (Continued)

PERIODIC TESTS AND INSPECTIONS

6.2.4.1.1 Cumulative dose contributions from liquid and gaseous effluents shall be determined in accordance with PERIODIC TESTS AND INSPECTIONS 6.2.1.2.1, 6.2.2.2.1, and 6.2.2.3.1, and in accordance with the methodology and parameters in the ODCM.

6.2.4.1.2 Cumulative dose contributions from direct radiation from unit operation shall be determined in accordance with the methodology and parameters in the ODCM.

6.3 REQUIREMENT FOR OPERABILITY
IN
SUPPORT
OF THE
RADIOLOGICAL ENVIRONMENTAL MONITORING PROGRAM

6.3 RADIOLOGICAL ENVIRONMENTAL MONITORING

6.3.1 MONITORING PROGRAM

REQUIREMENT FOR OPERABILITY

6.3.1.1 The radiological environmental monitoring program shall be conducted as specified in Table 6.3.1.1-1.

RELEVANT CONDITIONS: At all times.

COMPENSATORY MEASURES:

- a. With the radiological environmental monitoring program not being conducted as specified in Table 6.3.1.1-1, in lieu of a Licensee Event Report, prepare and submit to the Commission, in the Annual Radiological Environmental Operating Report, a description of the reasons for not conducting the program as required and the plans for preventing a recurrence.
- b. With the level of radioactivity as the result of plant effluents in an environmental sampling medium at a specified location exceeding the reporting levels of Table 6.3.1.1-2 when averaged over any calendar quarter, in lieu of a Licensee Event Report, prepare and submit to the Commission within 30 days, pursuant to 10 CFR 50, Appendix I, Section IV.A, a Special Report that identifies the cause(s) for exceeding the limit(s) and defines the corrective actions to be taken to reduce radioactive effluents so that the potential annual dose* to A MEMBER OF THE PUBLIC is less than the calendar year limits of Requirement for Operability 6.2.1.2, 6.2.2.2 and 6.2.2.3. When more than one of the radionuclides in Table 6.3.1.1-2 are detected in the sampling medium, this report shall be submitted if:

$$\frac{\text{concentration (1)}}{\text{reporting level (1)}} + \frac{\text{concentration (2)}}{\text{reporting level (2)}} + \dots \geq 1.0$$

When radionuclides other than those in Table 6.3.1.1-2 are detected and are the result of plant effluents, this report shall be submitted if the potential annual dose* to A MEMBER OF THE PUBLIC is equal to or greater than the calendar year limits of Requirement for Operability 6.2.1.2, 6.2.2.2 and 6.2.2.3. This report is not required if the measured level of radioactivity was not the result of plant effluents; however, in such an event, the condition shall be reported and described in the Annual Radiological Environmental Operating Report.

*The methodology and parameters used to estimate the potential annual dose to a MEMBER OF THE PUBLIC shall be indicated in this report.

RADIOLOGICAL ENVIRONMENTAL MONITORING

REQUIREMENT FOR OPERABILITY

COMPENSATORY MEASURES: (Continued)

- c. With milk or fresh leafy vegetable samples unavailable from one or more of the sample locations required by Table 6.3.1.1-1, identify locations for obtaining replacement samples and add them to the radiological environmental monitoring program within 30 days.

The specific locations from which samples were unavailable may then be deleted from the monitoring program. In lieu of a Licensee Event Report and in accordance with ODCM 6.4.1, identify the cause of the unavailability of samples and identify the new location(s) for obtaining replacement samples in the next Radioactive Effluent Release Report and also include in the report a revised figure(s) and table for the ODCM reflecting the new location(s).

- d. The provisions of Technical Specifications 3.0.3 and 3.0.4 are not applicable.

PERIODIC TESTS AND INSPECTIONS

6.3.1.1.1 The radiological environmental monitoring samples shall be collected pursuant to Table 6.3.1.1-1 from the specific locations given in the table and figure(s) in the ODCM, and shall be analyzed pursuant to the requirements of Table 6.3.1.1-1 and the detection capabilities required by Table 6.3.1.1.1-1.

TABLE 6.3.1.1-1

RADIOLOGICAL ENVIRONMENTAL MONITORING PROGRAM*

EXPOSURE PATHWAY AND/OR SAMPLE	NUMBER OF REPRESENTATIVE SAMPLES AND SAMPLE LOCATIONS ^a	SAMPLING AND COLLECTION FREQUENCY	TYPE AND FREQUENCY OF ANALYSIS
1. DIRECT RADIATION ^b	<p>34 routine monitoring stations either with two or more dosimeters or with one instrument for measuring and recording dose rate continuously, placed as follows:</p> <p>An inner ring of stations, one in each meteorological sector in the general area of the SITE BOUNDARY.</p> <p>An outer ring of stations, one in each of the meteorological sectors of NE, ENE, E, ESE, SE in the 6- to 9-km range from the site, and one in each of the meteorological sectors of N, NNE, SSE, S, SSW in the 9- to 12-km range from the site.</p> <p>The balance of the stations to be placed in special interest areas such as population centers, nearby residences, schools, and 1 or 2 areas to serve as control stations.</p>	Quarterly.	Gamma dose quarterly.

* The number, media, frequency, and location of samples may vary from site to site. This table presents an acceptable minimum program for a site at which each entry is applicable. Local site characteristics must be examined to determine if pathways not covered by this table may significantly contribute to an individual's dose and should be included in the sampling program.

TABLE 6.3.1.1.1-1 (Continued)

RADIOLOGICAL ENVIRONMENTAL MONITORING PROGRAM*

EXPOSURE PATHWAY AND/OR SAMPLE	NUMBER OF REPRESENTATIVE SAMPLES AND SAMPLE LOCATIONS*	SAMPLING AND COLLECTION FREQUENCY	TYPE AND FREQUENCY OF ANALYSIS
2. AIRBORNE			
Radioiodine and Particulates	Samples from 5 locations: 1 sample from close to the 1 SITE BOUNDARY location, having a high calculated annual average ground-level D/Q. Three samples from close to the 3 Columbia River locations having the highest calculated D/Q. One sample from the vicinity of a community having the highest calculated annual average ground-level D/Q. One sample from a control location, as for example 30-50 km distant and in the least prevalent wind direction.	Continuous sampler operation with sample collection weekly, or more frequently if required by dust loading.	<u>Radioiodine Canister:</u> I-131 analysis weekly. <u>Particulate Sampler:</u> Gross beta radioactivity analysis following filter change; ^c Gamma isotopic analysis ^d of composite (by location) quarterly.
3. WATERBORNE			
a. Surface ^e	1 sample upstream 1 sample downstream	Composite sample over 1-month period. ^f	Gamma isotopic analysis ^d monthly. Composite for tritium analysis quarterly.
b. Ground	Samples from 1 or 2 sources only if likely to be affected. ^g	Quarterly.	Gamma isotopic ^d and tritium analysis quarterly.

TABLE 6.3.1.1.1-1 (Continued)

RADIOLOGICAL ENVIRONMENTAL MONITORING PROGRAM*

EXPOSURE PATHWAY AND/OR SAMPLE	NUMBER OF REPRESENTATIVE SAMPLES AND SAMPLE LOCATIONS ^a	SAMPLING AND COLLECTION FREQUENCY	TYPE AND FREQUENCY OF ANALYSIS
3. WATERBORNE (Continued)			
c. Drinking	One sample of each of 1 to 3 of the nearest water supplies that could be affected by its discharge.	Composite sample over 2-week period ^c when I-131 analysis is performed, monthly composite otherwise.	I-131 analysis on each composite when the dose calculated for the consumption of the water is greater than 1 mrem per year. ^b
	One sample from a control location.		Composite for gross beta and gamma isotopic analysis ^d monthly. Composite for tritium analysis quarterly.
d. Sediment from shoreline	One sample from downstream area with existing or potential recreational value.	Semiannually.	Gamma isotopic analysis ^d semiannually.
4. INGESTION			
a. Milk	Samples from milking animals in 3 locations within 5 km distance having the highest dose potential. If there are none, then 1 sample from milking animals in each of 3 areas between 5-16 km distant where doses are calculated to be greater than 1 mrem per year. ^b	Semimonthly when animals are on pasture, monthly at other times.	Gamma isotopic ^d and I-131 analysis semi-monthly when animals are on pasture; monthly at other times.
	1 sample from milking animals at a control location, 30-50 km distant and in the least prevalent wind direction.		

TABLE 6.3.1.1.-1 (Continued)

RADIOLOGICAL ENVIRONMENTAL MONITORING PROGRAM*

EXPOSURE PATHWAY AND/OR SAMPLE	NUMBER OF REPRESENTATIVE SAMPLES AND SAMPLE LOCATIONS ^a	SAMPLING AND COLLECTION FREQUENCY	TYPE AND FREQUENCY OF ANALYSIS
4. INGESTION (Continued)			
b. Fish and Invertebrates	1 sample of each of three recreationally important species (one anadromous and two resident) in vicinity of plant discharge area.	Sample annually, unless an impact is indicated, then semiannually. ⁱ	Gamma isotopic analyses ^d on edible portions.
	1 sample of same species in areas not influenced by plant discharge.		
c. Food Products	1 sample of each principal class of food products from any area that is irrigated by water in which liquid plant wastes have been discharged.	At time of harvest. ^j	Gamma isotopic analyses ^d on edible portion.
	Samples of 3 different kinds of broad leaf vegetation grown nearest each of two different offsite locations of highest predicted annual average ground-level D/Q if milk sampling is not performed.	Monthly during growing season.	Gamma isotopic ^d and I-131 analysis.
	1 sample of each of the similar broad leaf vegetation grown 30-50 km distant in the least prevalent wind direction if milk sampling is not performed.	Monthly during growing season.	Gamma isotopic ^d and I-131 analysis.

TABLE 6.3.1.1-1 (Continued)

TABLE NOTATIONS

^a Specific parameters of distance and direction sector from the centerline of one reactor, and additional description where pertinent, shall be provided for each and every sample location in Table 6.3.1.1-1 in a table and figure(s) in the ODCM. Refer to NUREG-0133, "Preparation of Radiological Effluent Technical Specifications for Nuclear Power Plants," October 1978, and to Radiological Assessment Branch Technical Position, Revision 1, November 1979. Deviations are permitted from the required sampling schedule if specimens are unobtainable due to circumstances such as hazardous conditions, seasonal unavailability, and malfunction of automatic sampling equipment. If specimens are unobtainable due to sampling equipment malfunction, effort shall be made to complete corrective action prior to the end of the next sampling period. All deviations from the sampling schedule shall be documented in the Annual Radiological Environmental Operating Report. It is recognized that, at times, it may not be possible or practicable to continue to obtain samples of the media of choice at the most desired location or time. In these instances suitable alternative media and locations may be chosen for the particular pathway in question and appropriate substitutions made within 30 days in the radiological environmental monitoring program. In lieu of a Licensee Event Report, identify the cause of the unavailability of samples for that pathway and identify the new location(s) for obtaining replacement samples in the next Radioactive Effluent Release Report and also include in the report a revised figure(s) and table for the ODCM reflecting the new location(s).

^b One or more instruments, such as a pressurized ion chamber, for measuring and recording dose rate continuously may be used in place of, or in addition to, integrating dosimeters. For the purposes of this table, a thermoluminescent dosimeter (TLD) is considered to be one phosphor card with multiple readout areas; a phosphor card in a packet is considered to be equivalent to two or more dosimeters. Film badges shall not be used as dosimeters for measuring direct radiation. (The number of direct radiation monitoring stations may be reduced according to geographical limitations. The frequency of analysis or readout for TLD systems will depend upon the characteristics of the specific system used and should be selected to obtain optimum dose information with minimal fading.)

^c Airborne particulate sample filters shall be analyzed for gross beta radioactivity 24 hours or more after sampling to allow for radon and thoron daughter decay. If gross beta activity in air particulate samples is greater than 10 times the yearly mean of control samples, gamma isotopic analysis shall be performed on the individual samples.

^d Gamma isotopic analysis means the identification and quantification of gamma-emitting radionuclides that may be attributable to the effluents from the facility.

^e The "upstream sample" shall be taken at a distance beyond significant influence of the discharge. The "downstream" sample shall be taken in an area beyond but near the mixing zone.

TABLE 6.3.1.1-1 (Continued)

TABLE NOTATIONS

- f A composite sample is one in which the quantity (aliquot) of liquid is proportional to the quantity of flowing liquid and in which the method of sampling employed results in a specimen that is representative of the liquid flow. In this program composite sample aliquots shall be collected at time intervals that are very short (e.g., hourly) relative to the compositing period (e.g., monthly) in order to assure obtaining a representative sample.
- g Groundwater samples shall be taken when this source is tapped for drinking or irrigation purposes in areas where the hydraulic gradient or recharge properties are suitable for contamination.
- h The dose shall be calculated for the maximum organ and age group, using the methodology and parameters in the ODCM.
- i If any of the analytical results for Columbia River fish samples are significantly higher than the results of the Snake River samples or the results of previous fish samples, sampling will be conducted semiannually.
- j If harvest occurs more than once a year, sampling shall be performed during each discrete harvest. If harvest occurs continuously, sampling shall be monthly. Attention shall be paid to including samples of tuberous and root food products.

TABLE 6.3.1.1.1-2
REPORTING LEVELS FOR RADIOACTIVITY CONCENTRATIONS IN ENVIRONMENTAL SAMPLES

ANALYSIS	WATER (pCi/L)	AIRBORNE		FISH (pCi/kg, wet)	MILK (pCi/L)	FOOD PRODUCTS (pCi/kg, wet)
		WATER (pCi/L)	PARTICULATE OR GASES (pCi/m ³)			
H-3 ⁽¹⁾	2 x 10 ⁴					
Mn-54	1 x 10 ³			3 x 10 ⁴		
Fe-59	4 x 10 ²			1 x 10 ⁴		
Co-58	1 x 10 ³			3 x 10 ⁴		
Co-60	3 x 10 ²			1 x 10 ⁴		
Zn-65	3 x 10 ²			2 x 10 ⁴		
Zr-Nb-95	4 x 10 ²					
I-131	2	0.9			3	1 x 10 ²
Cs-134	30	10		1 x 10 ³	60	1 x 10 ³
Cs-137	50	20		2 x 10 ³	70	2 x 10 ³
Ba-La-140	2 x 10 ²				3 x 10 ²	

(1) For drinking water samples. The value given is the 40 CFR Part 141 value. If no drinking water pathway exists, a value of 30,000 pCi/L may be used.

TABLE 6.3.1.1.1-1

DETECTION CAPABILITIES FOR ENVIRONMENTAL SAMPLE ANALYSIS*

LOWER LIMIT OF DETECTION (LLD)^b

ANALYSIS	WATER (pCi/L)	AIRBORNE PARTICULATE OR GASES (pCi/m ³)	FISH (pCi/kg, wet)	MILK (pCi/L)	FOOD		
					PRODUCTS (pCi/kg, wet)	SEDIMENT (pCi/kg, dry)	
Gross beta	4	1 x 10 ⁻²					
H-3	2000*						
Mn-54	15		130				
Fe-59	30		260				
Co-58,60	15		130				
Zn-65	30		260				
Zr-95	30						
Nb-95	15						
I-131		7 x 10 ⁻²		1	60		
Cs-134	15	5 x 10 ⁻²	130	15	60	150	
Cs-137	18	6 x 10 ⁻²	150	18	80	180	
Ba-140	60			60			
La-140	15			15			

(*) If no drinking water pathway exists, a value of 3,000 pCi/L may be used.

TABLE 6.3.1.1.1-1 (Continued)

TABLE NOTATIONS

^a This list does not mean that only these nuclides are to be considered. Other peaks that are identifiable, together with those of the above nuclides, shall also be analyzed and reported in the Annual Radiological Environmental Operating Report.

^b Required detection capabilities for thermoluminescent dosimeters used for environmental measurements shall be in accordance with the recommendations of Regulatory Guide 4.13, except for specification regarding energy dependence. Correction factors shall be provided for energy ranges not meeting the energy dependence specification.

^c The LLD is defined for purposes of these specifications, as the smallest concentration of radioactive material in a sample that will yield a net count, above system background, that will be detected with 95% probability with only 5% probability of falsely concluding that a blank observation represents a "real" signal.

For a particular measurement system, which may include radiochemical separation:

$$LLD = \frac{4.66s_b}{E \cdot V \cdot 2.22 \cdot Y \cdot \exp(-\lambda \Delta t)}$$

Where:

LLD is the "a priori" lower limit of detection as defined above, as picocuries per unit mass or volume,

s_b is the standard deviation of the background counting rate or of the counting rate of a blank sample as appropriate, as counts per minute,

E is the counting efficiency, as counts per disintegration,

V is the sample size in units of mass or volume,

2.22 is the number of disintegrations per minute per picocurie,

Y is the fractional radiochemical yield, when applicable,

λ is the radioactive decay constant for the particular radionuclide, and

Δt for environmental samples is the elapsed time between sample collection, or end of the sample collection period, and time of counting.

Typical values of E, V, Y, and Δt should be used in the calculation.

TABLE 6.3.1.1.1-1 (Continued)

TABLE NOTATIONS

It should be recognized that the LLD is defined as an a priori (before the fact) limit representing the capability of a measurement system and not as an a posteriori (after the fact) limit for a particular measurement. Analyses shall be performed in such a manner that the stated LLDs will be achieved under routine conditions. Occasionally background fluctuations, unavoidable small sample sizes, the presence of interfering nuclides, or other uncontrollable circumstances may render these LLDs unachievable. In such cases, the contributing factors shall be identified and described in the Annual Radiological Environmental Operating Report.

- ^d LLD for drinking water samples. If no drinking water pathway exists, the LLD of gamma isotopic analysis may be used.

6.3 RADIOLOGICAL ENVIRONMENTAL MONITORING

6.3.2 LAND USE CENSUS

REQUIREMENT FOR OPERABILITY

6.3.2.1 A Land Use Census shall be conducted and shall identify within a distance of 8 km (5 miles) the location in each of the 16 meteorological sectors of the nearest milk animal, the nearest residence and the nearest garden* of greater than 50 m² (500 ft²) producing broad leaf vegetation.

RELEVANT CONDITIONS: At all times.

COMPENSATORY MEASURES:

- a. With a Land Use Census identifying a location(s) that yields a calculated dose or dose commitment greater than the values currently being calculated in Requirement for Operability 6.2.2.3.1, in lieu of a Licensee Event Report, identify the new location(s) in the next Radioactive Effluent Release Report.
- b. With a Land Use Census identifying a location(s) that yields a calculated dose or dose commitment (via the same exposure pathway) 20% greater than at a location from which samples are currently being obtained in accordance with Requirement for Operability 6.3.1.1, add the new location(s) to the radiological environmental monitoring program within 30 days. The sampling location(s), excluding the control station location having the lowest calculated dose or dose commitment(s), via the same exposure pathway, may be deleted from this monitoring program after October 31 of the year in which this Land Use Census was conducted. In lieu of a Licensee Event Report, identify the new location(s) in the next Radioactive Effluent Release Report and also include in the report a revised figure(s) and table for the ODCM reflecting the new location(s).
- c. The provisions of Technical Specifications 3.0.3 and 3.0.4 are not applicable.

PERIODIC TESTS AND INSPECTIONS

6.3.2.1.1 The Land Use Census shall be conducted during the growing season at least once per calendar year using that information that will provide the best results, such as by a door-to-door survey, aerial survey, or by consulting local agriculture authorities. The results of the Land Use Census shall be included in the Annual Radiological Environmental Operating Report.

*Broad leaf vegetation sampling of at least three different kinds of vegetation may be performed at the SITE BOUNDARY in each of two different direction sectors with the highest predicted D/Qs in lieu of the garden census. Specifications for broad leaf vegetation sampling in Table 6.3.1.1-1 shall be followed, including analysis of control samples.

6.3 RADIOLOGICAL ENVIRONMENTAL MONITORING

6.3.3 INTERLABORATORY COMPARISON PROGRAM

REQUIREMENT FOR OPERABILITY

6.3.3.1 Analyses shall be performed on all radioactive materials, supplied as part of an Interlaboratory Comparison Program that has been approved by the Commission, that correspond to samples required by Table 6.3.1.1-1.

RELEVANT CONDITIONS: At all times.

COMPENSATORY MEASURES:

- a. With analyses not being performed as required above, report the corrective actions taken to prevent a recurrence to the Commission in the Annual Radiological Environmental Operating Report.
- b. The provisions of Technical Specifications 3.0.3 and 3.0.4 are not applicable.

PERIODIC TESTS AND INSPECTIONS

6.3.3.1.1 The Interlaboratory Comparison Program shall be described in the ODCM. A summary of the results obtained as part of the above required Interlaboratory Comparison Program shall be included in the Annual Radiological Environmental Operating Report.

6.4 RADIOLOGICAL ENVIRONMENTAL
OPERATING/RADIOACTIVE EFFLUENT
RELEASE REPORT REQUIREMENTS

CONTROL OF CHANGES TO THE:
RADIOACTIVE LIQUID, GASEOUS, AND SOLID WASTE TREATMENT SYSTEMS

6.4.1 ANNUAL RADIOLOGICAL ENVIRONMENTAL OPERATING REPORT

Routine Radiological Environmental Operating Reports covering the operation of the unit during the previous calendar year shall be submitted prior to May 15 of each year.

The Annual Radiological Environmental Operating Reports shall include summaries, interpretations, and an analysis of trends of the results of the radiological environmental surveillance activities for the report period, including a comparison with preoperational studies, with operational controls as appropriate, and with previous environmental surveillance reports, and an assessment of the observed impacts of the plant operation on the environment. The reports shall also include the results of Land Use Censuses required by Requirement for Operability 6.3.2.1.

The Annual Radiological Environmental Operating Reports shall include the results of analysis of all radiological environmental samples and of all environmental radiation measurements taken during the period pursuant to the locations specified in the table and figures in the ODCM, as well as summarized and tabulated results of these analyses and measurements in the format of the table in the Radiological Assessment Branch Technical Position, Revision 1, November 1979. In the event that some individual results are not available for inclusion with the report, the report shall be submitted noting and explaining the reasons for the missing results. The missing data shall be submitted as soon as possible in a supplementary report.

The reports shall also include the following: a summary description of the radiological environmental monitoring program, at least two legible maps* covering all sampling locations keyed to a table giving distances and directions from the centerline of the reactor; the results of license participation in the Interlaboratory Comparison Program, required by Requirement for Operability 6.3.3.1; discussion of all deviations from the sampling schedule of Table 6.3.1.1-1; and discussion of all analyses in which the LLD required by Table 6.3.1.1.1-1 was not achievable.

* One map shall cover stations near the SITE BOUNDARY; a second shall include the more distant stations.

6.4.2 RADIOACTIVE EFFLUENT RELEASE REPORT

The routine Radioactive Effluent Release Report covering the operation of the unit shall be submitted in accordance with 10 CFR 50.36a(a)(2).

The Radioactive Effluent Release Report shall include a summary of the quantities of radioactive liquid and gaseous effluents and solid waste released from the unit as outlined in Regulatory Guide 1.21, "Measuring, Evaluating, and Reporting Radioactivity in Solid Wastes and Releases of Radioactive Materials in Liquid and Gaseous Effluents from Light-Water-Cooled Nuclear Power Plants," Revision 1, June 1974, with data summarized on a quarterly basis following the format of Appendix B thereof.

The Radioactive Effluent Release Report to be submitted within 60 days after January 1 of each year shall include an annual summary of hourly meteorological data collected over the previous year. This annual summary may be either in the form of an hour-by-hour listing on magnetic tape of wind speed, wind direction, atmospheric stability, and precipitation (if measured), or in the form of joint frequency distributions of wind speed, wind direction, and atmospheric stability. This same report shall include an assessment of the radiation doses due to the radioactive liquid and gaseous effluents released from the unit or station during the previous calendar year. This same report shall also include an assessment of the radiation doses from radioactive liquid and gaseous effluents to MEMBERS OF THE PUBLIC due to their activities inside the SITE BOUNDARY (ODCM Figure 3-1) during the report period. All assumptions used in making these assessments, i.e., specific activity, exposure time and location, shall be included in these reports. The meteorological conditions concurrent with the time of release of radioactive materials in gaseous effluents, as determined by sampling frequency and measurement, shall be used for determining the gaseous pathway doses. The assessment of radiation doses shall be performed in accordance with the methodology and parameters in the OFFSITE DOSE CALCULATION MANUAL (ODCM).

6.4.2 RADIOACTIVE EFFLUENT RELEASE REPORT (Continued)

The Radioactive Effluent Release Report shall also include once a year an assessment of radiation doses to the likely most exposed MEMBER OF THE PUBLIC from reactor releases and other nearby uranium fuel cycle sources, including doses from primary effluent pathways and direct radiation, for the previous calendar year to show conformance with 40 CFR Part 190, Environmental Radiation Protection Standards for Nuclear Power Operation. Acceptable methods for calculating the dose contribution from liquid and gaseous effluents are given in Regulatory Guide 1.109, Rev. 1, October 1977.

The Radioactive Effluent Release Report shall include the following information for each class of solid waste (as defined by 10 CFR Part 61) shipped offsite during the report period:

- a. Container volume,
- b. Total curie quantity (specify whether determined by measurement or estimate),
- c. Principal radionuclides (specify whether determined by measurement or estimate),
- d. Source of waste and processing employed (e.g., dewatered spent resin, compacted dry waste, evaporator bottoms),
- e. Type of container (e.g., LSA, Type A, Type B, Large Quantity), and
- f. Solidification agent or absorbent (e.g., cement, urea formaldehyde).

The Radioactive Effluent Release Reports shall include a list and description of unplanned releases from the site to UNRESTRICTED AREAS of radioactive materials in gaseous and liquid effluents made during the reporting period.

The Radioactive Effluent Release Reports shall include any changes made during the reporting period to the PROCESS CONTROL PROGRAM (PCP) and to the OFFSITE DOSE CALCULATION MANUAL (ODCM), as well as a listing of new locations for dose calculations and/or environmental monitoring identified by the Land Use Census pursuant to Requirement for Operability 6.3.2.1.

6.4.3 MAJOR CHANGES TO RADIOACTIVE LIQUID, GASEOUS, AND SOLID WASTE TREATMENT SYSTEMS*

Licensee initiated major changes to the radioactive waste systems (liquid, gaseous, and solid):

- a. Shall be reported to the Commission in the Radioactive Effluent Release Report for the period in which the evaluation was reviewed by the POC. The discussion of each change shall contain:
 1. A summary of the evaluation that led to the determination that the change could be made in accordance with 10 CFR 50.59;
 2. Sufficient detailed information to totally support the reason for the change without benefit of additional or supplemental information;
 3. A detailed description of the equipment, components, and processes involved and the interface with other plant systems;
 4. An evaluation of the change, which shows the predicted releases of radioactive materials in liquid and gaseous effluents and/or quantity of solid waste that differ from those previously predicted in the license application and amendments thereto;
 5. An evaluation of the change, which shows the expected maximum exposures to a MEMBER OF THE PUBLIC in the UNRESTRICTED AREA and to the general population that differ from those previously estimated in the license application and amendments thereto;
 6. A comparison of the predicted releases of radioactive materials, in liquid and gaseous effluents and in solid waste, to the actual releases for the period prior to when the changes are to be made;
 7. An estimate of the exposure to plant operating personnel as a result of the change; and
 8. Documentation of the fact that the change was reviewed and found acceptable by the POC.
- b. Shall become effective upon review and acceptance by the POC.

* Licensees may choose to submit the information called for in this specification as part of the annual FSAR update.

6.5 BASES
FOR
RADIOACTIVE EFFLUENTS MONITORING
REQUIREMENT FOR OPERABILITY

B6.1 INSTRUMENTATION

BASES

MONITORING INSTRUMENTATION

B6.1.1 RADIOACTIVE LIQUID EFFLUENT MONITORING INSTRUMENTATION

The radioactive liquid effluent instrumentation is provided to monitor and control, as applicable, releases of radioactive materials in liquid effluents during actual radioactive releases or potentially radioactive releases of liquid effluents. The alarm/trip setpoints for these instruments shall be calculated and adjusted in accordance with the methodology and parameters in the ODCM to ensure that the alarm/trip will occur prior to exceeding the limits of 10 CFR Part 20. The OPERABILITY and use of this instrumentation is consistent with the requirements of General Design Criteria 60, 63, and 64 of Appendix A to 10 CFR Part 50. The purpose of tank level indicating devices is to assure the detection and control of leaks that if not controlled could potentially result in the transport of radioactive materials to UNRESTRICTED AREAS.

B6.1.2 RADIOACTIVE GASEOUS EFFLUENT MONITORING INSTRUMENTATION

The radioactive gaseous effluent instrumentation is provided to monitor and control, as applicable, releases of radioactive materials in gaseous effluents during actual radioactive releases or potentially radioactive releases of gaseous effluents. The alarm/trip setpoints for these instruments shall be calculated and adjusted in accordance with the methodology and parameters in the ODCM to ensure that the alarm/trip will occur prior to exceeding the limits of 10 CFR Part 20. This instrumentation also includes provisions for monitoring the concentrations of potentially explosive gas mixtures in the WASTE GAS HOLDUP SYSTEM. The OPERABILITY and use of this instrumentation is consistent with the requirements of General Design Criteria 60, 63, and 64 of Appendix A to 10 CFR Part 50.

B6.2 RADIOACTIVE EFFLUENTS

BASES

B6.2.1 LIQUID EFFLUENTS

B6.2.1.1 CONCENTRATION

This Requirement for Operability is provided to ensure that the concentration of radioactive materials released in liquid waste effluents to UNRESTRICTED AREAS will be less than the concentration levels specified in 10 CFR Part 20, Appendix B, Table II, Column 2. This limitation provides additional assurance that the levels of radioactive materials in bodies of water in UNRESTRICTED AREAS will result in exposures within (1) the Section II.A design objectives of Appendix I, 10 CFR Part 50, to a MEMBER OF THE PUBLIC and (2) the limits of 10 CFR 20.106(e) to the population. The concentration limit for dissolved or entrained noble gases is based upon the assumption that Xe-135 is the controlling radioisotope and its MPC in air (submersion) was converted to an equivalent concentration in water using the methods described in International Commission on Radiological Protection (ICRP) Publication 2.

This Requirement for Operability applies to the release of radioactive materials in liquid effluents from all reactor units at the site.

The required detection capabilities for radioactive materials in liquid waste samples are tabulated in terms of the lower limits of detection (LLDs). Detailed discussion of the LLD, and other detection limits can be found in HASL Procedures Manual, HASL-300 (revised annually), Currie, L. A., "Limits for Qualitative Detection and Quantitative Determination - Application to Radiochemistry," Anal. Chem. 40, 586-93 (1968), and Hartwell, J. K., "Detection Limits for Radioanalytical Counting Techniques," Atlantic Richfield Hanford Company Report ARH-SA-215 (June 1975).

B6.2.1.2 DOSE

This Requirement for Operability is provided to implement the requirements of Sections II.A, III.A, and IV.A of Appendix I, 10 CFR Part 50. The Requirement for Operability implements the guides set forth in Section II.A of Appendix I. The COMPENSATORY MEASURES statements provide the required operating flexibility and at the same time implement the guides set forth in Section IV.A of Appendix I to assure that the releases of radioactive material in liquid effluents to UNRESTRICTED AREAS will be kept "as low as is reasonably achievable." Also, for fresh water sites with drinking water supplies that can be potentially affected by plant operations, there is reasonable assurance that the operation of the facility will not result in radionuclide concentrations in the finished drinking water that are in excess of the requirements of 40 CFR Part 141. The dose calculation methodology and parameters in the ODCM implement the requirements in Section III.A of Appendix I that conformance with the guides of

B6.2.1.2 DOSE (Continued)

Appendix I be shown by calculational procedures based on models and data, such that the actual exposure of a MEMBER OF THE PUBLIC through appropriate pathways is unlikely to be substantially underestimated. The equations specified in the ODCM for calculating the doses due to the actual release rates of radioactive materials in liquid effluents are consistent with the methodology provided in Regulatory Guide 1.109, "Calculation of Annual Doses to Man from Routine Releases of Reactor Effluents for the Purpose of Evaluating Compliance with 10 CFR Part 50, Appendix I," Revision 1, October 1977 and Regulatory Guide 1.113, "Estimating Aquatic Dispersion of Effluents from Accidental and Routine Reactor Releases for the Purpose of Implementing Appendix I," April 1977.

This Requirement for Operability applies to the release of radioactive materials in liquid effluents from each reactor unit at the site.

B6.2.1.3 LIQUID RADWASTE TREATMENT SYSTEM

The OPERABILITY of the liquid radwaste treatment system ensures that this system will be available for use whenever liquid effluents require treatment prior to release to the environment. The requirement that the appropriate portions of this system be used, when specified, provides assurance that the releases of radioactive materials in liquid effluent will be kept "as low as is reasonably achievable." This Requirement for Operability implements the requirements of 10 CFR 50.36a, General Design Criterion 60 of Appendix A to 10 CFR Part 50 and the design objective given in Section II.D of Appendix I to 10 CFR Part 50. The specified limits governing the use of appropriate portions of the liquid radwaste treatment system were specified as a suitable fraction of the dose design objectives set forth in Section II.A of Appendix I, 10 CFR Part 50, for liquid effluents.

This Requirement for Operability applies to the release of radioactive materials in liquid effluents from each reactor unit at the site.

B6.2.2 GASEOUS EFFLUENTS

B6.2.2.1 DOSE RATE

This Requirement for Operability is provided to ensure that the dose at any time at and beyond the SITE BOUNDARY from gaseous effluents from all units on the site will be within the annual dose limits of 10 CFR Part 20 to UNRESTRICTED AREAS. The annual dose limits are the doses associated with the concentrations of 10 CFR Part 20, Appendix B, Table II, Column 1. These limits provide reasonable assurance that radioactive material discharged in gaseous effluents will not result in the exposure of a MEMBER OF THE PUBLIC in an UNRESTRICTED AREA, either within or outside the SITE BOUNDARY, to annual average concentrations exceeding the limits specified in Appendix B, Table II of 10 CFR Part 20 (10 CFR 20.1302(b)). For MEMBERS OF THE PUBLIC who may at times be within the SITE

B6.2.2.1 DOSE RATE (Continued)

BOUNDARY, the occupancy of that MEMBER OF THE PUBLIC will usually be sufficiently low to compensate for any increase in the atmospheric diffusion factor above that for the SITE BOUNDARY. Examples of calculations for such MEMBERS OF THE PUBLIC, with the appropriate occupancy factors, is provided in the ODCM. The specified release rate limits restrict, at all times, the corresponding gamma and beta dose rates above background to a MEMBER OF THE PUBLIC at or beyond the SITE BOUNDARY to less than or equal to 500 mrems/year to the total body or to less than or equal to 3000 mrems/year to the skin. These release rate limits also restrict, at all times, the corresponding thyroid dose rate above background to a child via the inhalation pathway to less than or equal to 1500 mrems/year.

This Requirement for Operability applies to the release of radioactive materials in gaseous effluents from all reactor units at the site.

The required detection capabilities for radioactive materials in gaseous waste samples are tabulated in terms of the lower limits of detection (LLDs). Detailed discussion of the LLD and other detection limits can be found in HASL Procedures Manual, HASL-300 (revised annually), Currie, L. A., "Limits for Qualitative Detection and Quantitative Determination - Application to Radio-chemistry," Anal. Chem. 40, 586-93 (1968), and Hartwell, J. K. , "Detection Limits for Radioanalytical Counting Techniques," Atlantic Richfield Hanford Company Report ARH-SA-215 (June 1975).

B6.2.2.2 DOSE - NOBLE GASES

This Requirement for Operability is provided to implement the requirements of Sections II.B, III.A, and IV.A of Appendix I, 10 CFR Part 50. The Requirement for Operability implements the guides set forth in Section II.B of Appendix I. The COMPENSATORY MEASURES statements provide the required operating flexibility and at the same time implement the guides set forth in Section IV.A of Appendix I to assure that the releases of radioactive material in gaseous effluents to UNRESTRICTED AREAS will be kept "as low as is reasonably achievable." The PERIODIC TESTS AND INSPECTIONS requirements implement the requirements in Section III.A of Appendix I that conformance with the guides of Appendix I be shown by calculational procedures based on models and data such that the actual exposure of a MEMBER OF THE PUBLIC through appropriate pathways is unlikely to be substantially underestimated. The dose calculation methodology and parameters established in the ODCM for calculating the doses due to the actual release rates of radioactive noble gases in gaseous effluents are consistent with the methodology provided in Regulatory Guide 1.109, "Calculation of Annual Doses to Man from Routine Releases of Reactor Effluents for the Purpose of Evaluating Compliance with 10 CFR Part 50, Appendix I," Revision 1, October 1977 and Regulatory Guide 1.111, "Methods for Estimating Atmospheric Transport and Dispersion of Gaseous Effluents in Routine Releases from Light-Water Cooled Reactors," Revision 1, July 1977. The ODCM equations provided for determining the air doses at and beyond the SITE BOUNDARY are based upon the historical average atmospheric conditions.

B6.2.2.2 DOSE - NOBLE GASES (Continued)

This Requirement for Operability applies to the release of radioactive materials in gaseous effluents from each reactor unit at the site.

B6.2.2.3 DOSE - IODINE- 131, IODINE- 133, TRITIUM, AND RADIONUCLIDES IN PARTICULATE FORM

This Requirement for Operability is provided to implement the requirements of Sections II.C, III.A, and IV.A of Appendix I, 10 CFR Part 50. The Requirement for Operability are the guides set forth in Section II.C of Appendix I. The COMPENSATORY MEASURES statements provide the required operating flexibility and at the same time implement the guides set forth in Section IV.A of Appendix I to assure that the releases of radioactive materials in gaseous effluents to UNRESTRICTED AREAS will be kept "as low as is reasonably achievable." The ODCM calculational methods specified in the Requirement for Operability implement the requirements in Section III.A of Appendix I that conformance with the guides of Appendix I be shown by calculational procedures based on models and data, such that the actual exposure of a MEMBER OF THE PUBLIC through appropriate pathways is unlikely to be substantially underestimated. The ODCM calculational methodology and parameters for calculating the doses due to the actual release rates of the subject materials are consistent with the methodology provided in Regulatory Guide 1.109, "Calculation of Annual Doses to Man from Routine Releases of Reactor Effluents for the Purpose of Evaluating Compliance with 10 CFR Part 50, Appendix I," Revision 1, October 1977 and Regulatory Guide 1.111, "Methods for Estimating Atmospheric Transport and Dispersion of Gaseous Effluents in Routine Releases from Light-Water-Cooled Reactors," Revision 1, July 1977. These equations also provide for determining the actual doses based upon the historical average atmospheric conditions or concurrent meteorology. The release rate specifications for iodine-131, iodine-133, tritium, and radionuclides in particulate form with half-lives greater than 8 days are dependent upon the existing radionuclide pathways to man, in the areas at and beyond the SITE BOUNDARY. The pathways that were examined in the development of these calculations were: (1) individual inhalation of airborne radionuclides, (2) deposition of radionuclides onto green leafy vegetation with subsequent consumption by man, (3) deposition onto grassy areas where milk animals and meat-producing animals graze with consumption of the milk and meat by man, and (4) deposition on the ground with subsequent exposure of man.

This Requirement for Operability applies to the release of radioactive materials in gaseous effluents from each reactor unit at the site.

B6.2 RADIOACTIVE EFFLUENTS

BASES

B6.2.2.4 and 6.2.2.5 GASEOUS OFFGAS RADWASTE TREATMENT SYSTEM and VENTILATION EXHAUST TREATMENT SYSTEM

The OPERABILITY of the GASEOUS OFFGAS RADWASTE TREATMENT SYSTEM and the VENTILATION EXHAUST TREATMENT SYSTEM ensures that the systems will be available for use whenever gaseous effluents require treatment prior to release to the environment. The requirement that the appropriate portions of these systems be used, when specified, provides reasonable assurance that the releases of radioactive materials in gaseous effluents will be kept "as low as is reasonably achievable." This Requirement for Operability implements the requirements of 10 CFR 50.36a, General Design Criterion 60 of Appendix A to 10 CFR Part 50, and the design objectives given in Section II.D of Appendix I to 10 CFR Part 50. The specified limits governing the use of appropriate portions of the systems were specified as a suitable fraction of the dose design objectives set forth in Sections II.B and II.C of Appendix I, 10 CFR Part 50, for gaseous effluents.

B6.2.2.6 VENTING OR PURGING

This Requirement for Operability provides reasonable assurance that releases from containment VENTING or PURGING operations will not exceed the annual dose limits of 10 CFR Part 20 for unrestricted areas.

In Modes 1, 2, or 3, the requirement to have one OPERABLE standby gas treatment system train, in addition to one functional train for VENTING or PURGING when using the 24-inch or 30-inch exhaust valves, provides assurance that the gases exhausted from primary containment are properly filtered prior to release. Standby gas treatment system train functionality shall include the ability to accept the exhaust gases from primary containment, process the gases through the filtration unit, and discharge the gases to either the reactor building stack or the reactor building. The requirement to have an additional OPERABLE standby gas treatment system train addresses the fact that when the 24-inch or 30-inch exhaust valves are used, the in-service standby gas treatment system train used for filtration of the exhaust gases is INOPERABLE due to the potential for post-LOCA overpressurization of that train. The overpressurization is caused by the postulated rapid pressurization of containment during a LOCA which occurs before the qualified containment isolation valves close in 4-5 seconds from receipt of a high drywell pressure signal.

In Mode 4 when VENTING or PURGING through the 24-inch or 30-inch exhaust lines, it is acceptable to have only one functional standby gas treatment system train, and to have that train in service supporting the VENTING or PURGING. This functional filtration will assure the requirements of 10 CFR 20 are met. In Mode 4 there are no postulated accidents that could result in overpressurization of the standby gas treatment system train.

B6.2.2.6 VENTING OR PURGING (Continued)

The requirements associated with VENTING or PURGING through the 2-inch lines ensure that primary containment gases are exhausted through a standby gas treatment system train capable of providing the necessary filtration to meet 10 CFR 20 requirements for unrestricted areas. Additional restrictions on standby gas treatment system OPERABILITY are not required in the ODCM since the flow through the 2-inch lines will not overpressurize the train, and these 2-inch lines are automatically isolated during a LOCA by primary containment isolation valves.

Additional requirements for standby gas treatment system OPERABILITY are found in the WNP-2 Technical Specifications.

B6.2.3.1 SOLID RADIOACTIVE WASTE

This Requirement for Operability implements the requirements of 10 CFR 50.36a and General Design Criterion 60 of Appendix A to 10 CFR Part 50. The process parameters included in establishing the PROCESS CONTROL PROGRAM may include, but are not limited to, waste type, waste pH, waste/liquid/solidification agent/catalyst ratios, waste oil content, waste principal chemical constituents, mixing and curing times.

B6.2 RADIOACTIVE EFFLUENTS

BASES

B6.2.4.1 TOTAL DOSE

This Requirement for Operability is provided to meet the dose limitations of 40 CFR Part 190 that have been incorporated into 10 CFR Part 20 by 46 FR 18525. The Requirement for Operability requires the preparation and submittal of a Special Report whenever the calculated doses from plant generated radioactive effluents and direct radiation exceed 25 mrems to the total body or any organ, except the thyroid, which shall be limited to less than or equal to 75 mrems. For sites containing up to four reactors, it is highly unlikely that the resultant dose to a MEMBER OF THE PUBLIC will exceed the dose limits of 40 CFR Part 190 if the individual reactors remain within twice the dose design objectives of Appendix I, and if direct radiation doses from the reactor units and outside storage tanks are kept small. The Special Report will describe a course of action that should result in the limitation of the annual dose to a MEMBER OF THE PUBLIC to within the 40 CFR Part 190 limits. For the purposes of the Special Report, it may be assumed that the dose commitment to the MEMBER OF THE PUBLIC from other uranium fuel cycle sources is negligible with the exception that dose contributions from other nuclear fuel cycle facilities at the same site or within a radius of 8 km must be considered. If the dose to any MEMBER OF THE PUBLIC is estimated to exceed the requirements of 40 CFR Part 190, the Special Report with a request for a variance (provided the release conditions resulting in violation of 40 CFR Part 190 have not already been corrected), in accordance with the provisions of 40 CFR 190.11 and 10 CFR 20.405c, is considered to be a timely request and fulfills the requirements of 40 CFR Part 190 until NRC staff action is completed. The variance only relates to the limits of 40 CFR Part 190, and does not apply in any way to the other requirements for dose limitation of 10 CFR Part 20, as addressed in Requirement for Operability 6.2.1.1 and 6.2.2.1. An individual is not considered a MEMBER OF THE PUBLIC during any period in which he/she is engaged in carrying out any operation that is part of the nuclear fuel cycle.

B6.3 RADIOLOGICAL ENVIRONMENTAL MONITORING

BASES

B6.3.1.1 MONITORING PROGRAM

The radiological environmental monitoring program required by this Requirement for Operability provides representative measurements of radiation and of radioactive materials in those exposure pathways and for those radionuclides that lead to the highest potential radiation exposures of MEMBERS OF THE PUBLIC resulting from the plant operation. This monitoring program implements Section IV.B.2 of Appendix I to 10 CFR Part 50 and thereby supplements the radiological effluent monitoring program by verifying that the measurable concentrations of radioactive materials and levels of radiation are not higher than expected on the basis of the effluent measurements and the modeling of the environmental exposure pathways. Guidance for this monitoring program is provided by the Radiological Assessment Branch Technical Position on Environmental Monitoring. The initially specified monitoring program will be effective for at least the first 3 years of commercial operation. Following this period, program changes may be initiated on operational experience.

The required detection capabilities for environmental sample analyses are tabulated in terms of the lower limits of detection (LLDs). The LLDs required by Table 6.3.1.1.1-1 are considered optimum for routine environmental measurements in industrial laboratories. It should be recognized that the LLD is defined as an a priori (before the fact) limit representing the capability of a measurement system and not as an a posteriori (after the fact) limit for a particular measurement.

Detailed discussion on the LLD, and other detection limits, can be found in HASL Procedures Manual, HASL-300 (revised annually), Currie, L. A., "Limits for Qualitative Detection and Quantitative Determination - Application to Radiochemistry," Anal. Chem. 40, 586-93 (1968), and Hartwell, J. K., "Detection Limits for Radioanalytical Counting Techniques," Atlantic Richfield Hanford Company Report ARH-SA-215 (June 1975).

B6.3.2.1 LAND USE CENSUS

This Requirement for Operability is provided to ensure that changes in the use of areas at and beyond the SITE BOUNDARY are identified and that modifications to the radiological environmental monitoring program are made if required by the results of this census. The best information from the door-to-door survey, from aerial survey or from consulting with local agricultural authorities shall be used. This census satisfies the requirements of Section IV.B.3 of Appendix I to 10 CFR Part 50. Restricting the census to gardens of greater than 50 m² provides assurance that significant exposure pathways via leafy vegetables will be identified and

B6.3.2.1 LAND USE CENSUS (continued)

monitored since a garden of this size is the minimum required to produce the quantity (26 kg/year) of leafy vegetables assumed in Regulatory Guide 1.109 for consumption by a child. To determine this minimum garden size, the following assumptions were made: (1) 20% of the garden was used for growing broad leaf vegetation (i.e., similar to lettuce and cabbage), and (2) a vegetation yield of 2 kg/m².

B6.3.3.1 INTERLABORATORY COMPARISON PROGRAM

The requirement for participation in an approved Interlaboratory Comparison Program is provided to ensure that independent checks on the precision and accuracy of the measurements of radioactive material in environmental sample matrices are performed as part of the quality assurance program for environmental monitoring in order to demonstrate that the results are valid for the purposes of Section IV.B.2 of Appendix I to 10 CFR Part 50.