

Exelon Generation Company, LLC www.exeloncorp.com
Braidwood Station
35100 South Rt 53, Suite 84
Braceville, IL 60407-9619
Tel. 815-458-2801

April 26, 2002
BW020031

U. S. Nuclear Regulatory Commission
ATTN: Document Control Desk
Washington, D.C. 20555-0001

Braidwood Station, Units 1 and 2
Facility Operating License Nos. NPF-72 and NPF-77
NRC Docket Nos. STN 50-456 and STN 50-457

Subject: 2001 Radioactive Effluent Release Report

The attached document includes the Radioactive Effluent Release Report for Braidwood Station. This report is being submitted in accordance with 10 CFR 50.36a, "Technical specifications on effluents from nuclear power reactors," and Technical Specification 5.6.3, "Radioactive Effluent Release Report," and includes a summary of radiological liquid and gaseous effluents and solid waste released from the site from January 2001 through December 2001.

If you have any questions regarding this information, please contact Ms. Amy Ferko, Regulatory Assurance Manager, at (815) 417-2699.

Respectfully,

James D. von Suskil
Site Vice President
Braidwood Station

Attachment

cc: Regional Administrator – NRC Region III
 NRC Senior Resident Inspector – Braidwood Station

IE48

bcc: Braidwood Station Project Manager, NRR - NRC
Nicholas Reynolds - Winston & Strawn
Office of Nuclear Facility Safety - Illinois Department of Nuclear Safety
Vice President - Licensing and Regulatory Affairs
Director, Licensing - Midwest Regional Operating Group
Regulatory Assurance Manager - Braidwood Station
Manager, Licensing - Braidwood and Byron Stations
Braidwood Nuclear Licensing Administrator
Exelon Document Control Desk Licensing (Hard Copy)
Exelon Document Control Desk Licensing (Electronic Copy)

ATTACHMENT

2001 Radioactive Effluent
Release Report for
Braidwood Station

RADIOACTIVE EFFLUENT RELEASE REPORT

Supplemental Information

January - December 2001

Facility: BRAIDWOOD NUCLEAR POWER STATION

Licensee: COMMONWEALTH EDISON COMPANY

1. Regulatory Limits

a. For Noble Gases:

Dose Rate

- 1) Less than 500 mrem/year to the whole body.
- 2) Less than 3000 mrem/year to the skin.

Dose Gamma Radiation

- 1) Less than or equal to 5 mrad/quarter.
- 2) Less than or equal to 10 mrad/year.

Beta Radiation

- 1) Less than or equal to 10 mrad/quarter.
- 2) Less than or equal to 20 mrad/year.

b.,c. For Iodine-131, for Iodine-133, and for all radionuclides in particulate form with half-lives greater than 8 days.

Dose Rate

- 1) Less than 1500 mrem/year.

Dose

- 1) Less than or equal to 7.5 mrem/quarter.
- 2) Less than or equal to 15 mrem/year.

d. For Liquid

- 1) Less than or equal to 1.5 mrem to the whole body during any calendar quarter.
- 2) Less than or equal to 5 mrem to any organ during any calendar quarter.
- 3) Less than or equal to 3 mrem to the whole body during any calendar year.
- 4) Less than or equal to 10 mrem to any organ during any calendar year.

2. Maximum Permissible Concentration

- a., b., c., For fission and activation gases, iodines, and particulates with half-lives greater than 8 days, allowable release limits are calculated by solving equations 10.1 and 10.2 from the Offsite Dose Calculation Manual.
- d. For liquid effluents, allowable release limits are calculated by solving equations 10.3 and 10.4 from the Offsite Dose Calculation Manual.

3. Average Energy

The average gamma energy for the Braidwood noble gas waste streams was 0.872 MeV for Unit 1 and 0.730 MeV for Unit 2. The average beta energy for Braidwood noble gas waste streams was 0.344 MeV for Unit 1 and 0.306 MeV for Unit 2.

4. Measurements and Approximations of Total Radioactivity

a. Fission and Activation Gases, Iodines, and Particulates

Containment batch releases are analyzed for noble gas and tritium before being discharged by gamma isotopic and scintillation, respectively. Gaseous decay tanks are analyzed for noble gas before being discharged by gamma isotopic. Released activity is normally calculated using volume of release, which is determined by change in tank or containment pressure.

The Auxiliary Building ventilation exhaust system is continually monitored for iodines and particulates. These samples are pulled every 7 days and analyzed by gamma isotopic. The particulate samples are also analyzed quarterly for gross alpha and Sr-89/90. However, on 5/19/01, continuous sampling for particulates and iodines for Unit 2 was not performed due to significant moisture in the effluent stream following a Unit 2 reactor trip. Both process monitors on the Unit 2 vent stack became saturated and were declared inoperable. Process monitor 2PR28J failed at 0453 (Condition Report A2001-01489), and the 2PR30J (Condition Report A2001-01490), failed at 0749. The 2PR30J was restored at 1100 hours and continuous sampling of the vent stack resumed.

Noble gas and tritium grab samples are pulled and analyzed weekly by gamma isotopic and scintillation, respectively. The average flow at the release points are used to calculate the curies released.

b. Liquid Effluents

The liquid release tanks are analyzed before discharge by gamma isotopic and for tritium. A representative portion of this sample is saved. This is composited, every 31 days, with other discharges that occurred and is analyzed for tritium and gross alpha. The batch composites are composited quarterly and sent to a vendor for Sr-89/90 and Fe-55 analysis. Circulating Water Blowdown, Condensate Polisher Sump and Waste Water Treatment are analyzed weekly by gamma isotopic and for tritium. These weekly samples are composited quarterly and sent to a vendor for Sr-89/90 and Fe-55 analysis.

The tank volumes and activities are used to calculate the curies released for the liquid release tanks. The total volume of water released and the activity is used to calculate the diluted activity released at the discharge point from batch discharges.

c. Less than the lower limit of detection (<LLD).

Samples are analyzed such that the Offsite Dose Calculation Manual (ODCM) LLD requirements are met. When a nuclide is not detected during the quarter then <LLD is reported.

BRAIDWOOD NUCLEAR POWER STATION
ANNUAL EFFLUENT REPORT FOR 2001
GAS RELEASES
UNIT 1 (Docket Number 50-456)
SUMMATION OF ALL RELEASES

| Units | 1st Qtr | 2nd Qtr | 3rd Qtr | 4th Qtr | Total |
|-------|---------|---------|---------|---------|-------|
|-------|---------|---------|---------|---------|-------|

A. Fission and Activation Gas Releases

| | | | | | | |
|---------------------------|---------|----------|----------|----------|----------|-----------------|
| 1. Total Release Activity | Ci | 8.45E-02 | 9.28E-02 | 1.19E-01 | 5.38E-02 | 3.50E-01 |
| 2. Average Release Rate | uCi/sec | 1.09E-02 | 1.18E-02 | 1.50E-02 | 6.77E-03 | 1.11E-02 |

B. Iodine Releases

| | | | | | | |
|-------------------------|---------|------|------|------|----------|-----------------|
| 1. Total I-131 Activity | Ci | <LLD | <LLD | <LLD | 2.35E-06 | 2.35E-06 |
| 2. Average Release Rate | uCi/sec | <LLD | <LLD | <LLD | 2.96E-07 | 7.45E-08 |

C. Particulate (> 8 day half-life) Releases

| | | | | | | |
|-------------------------|---------|------|----------|------|------|-----------------|
| 1. Gross Activity | Ci | <LLD | 1.70E-07 | <LLD | <LLD | 1.70E-07 |
| 2. Average Release Rate | uCi/sec | <LLD | 2.16E-08 | <LLD | <LLD | 5.39E-09 |
| 3. Gross Alpha Activity | Ci | <LLD | <LLD | <LLD | <LLD | <LLD |

D. Tritium Releases

| | | | | | | |
|---------------------------|---------|----------|----------|----------|----------|-----------------|
| 1. Total Release Activity | Ci | 3.16E+01 | 1.17E+01 | 2.43E+00 | 1.11E+00 | 4.68E+01 |
| 2. Average Release Rate | uCi/sec | 4.06E+00 | 1.49E+00 | 3.06E-01 | 1.40E-01 | 1.48E+00 |

**E. Sum of Iodine, Particulate (> 8 day half-life),
and Tritium Releases.**

| | | | | | | |
|---------------------------|----|----------|----------|----------|----------|-----------------|
| 1. Total Release Activity | Ci | 3.16E+01 | 1.17E+01 | 2.43E+00 | 1.11E+00 | 4.68E+01 |
|---------------------------|----|----------|----------|----------|----------|-----------------|

Note: LLD Values are included in Appendix A of this report.

Note: % Limit Values are included in Appendix B of this report.

BRAIDWOOD NUCLEAR POWER STATION
ANNUAL EFFLUENT REPORT FOR 2001
GAS RELEASES
UNIT 1 (Docket Number 50-456)
BATCH MODE

| Units | 1st Qtr | 2nd Qtr | 3rd Qtr | 4th Qtr | Total |
|-------|---------|---------|---------|---------|-------|
|-------|---------|---------|---------|---------|-------|

A. Particulate (> 8 day half-life) Releases

| | | | | | | |
|-----------|----|---|---|---|---|---|
| Cr-51 | Ci | * | * | * | * | * |
| Mn-54 | Ci | * | * | * | * | * |
| Co-57 | Ci | * | * | * | * | * |
| Co-58 | Ci | * | * | * | * | * |
| Fe-59 | Ci | * | * | * | * | * |
| Co-60 | Ci | * | * | * | * | * |
| Zn-65 | Ci | * | * | * | * | * |
| Sr-89 | Ci | * | * | * | * | * |
| Sr-90 | Ci | * | * | * | * | * |
| Mo-99 | Ci | * | * | * | * | * |
| Sn-117m | Ci | * | * | * | * | * |
| Cs-134 | Ci | * | * | * | * | * |
| Cs-137 | Ci | * | * | * | * | * |
| Ba/La-140 | Ci | * | * | * | * | * |
| Ce-141 | Ci | * | * | * | * | * |
| Ce-144 | Ci | * | * | * | * | * |

* Value reported as Continuous Mode

B. Tritium Releases

| | | | | | | |
|---------------------------|----|----------|----------|----------|----------|----------|
| 1. Total Release Activity | Ci | 1.75E-01 | 1.96E-01 | 1.15E+00 | 2.01E-01 | 1.72E+00 |
|---------------------------|----|----------|----------|----------|----------|----------|

C. Fission and Activation Gas Releases

| | | | | | | |
|---------|----|----------|----------|----------|----------|----------|
| Ar-41 | Ci | 6.84E-02 | 7.21E-02 | 7.61E-02 | 3.66E-02 | 2.53E-01 |
| Kr-85 | Ci | <LLD | <LLD | <LLD | <LLD | <LLD |
| Kr-85m | Ci | <LLD | <LLD | <LLD | <LLD | <LLD |
| Kr-87 | Ci | <LLD | <LLD | <LLD | <LLD | <LLD |
| Kr-88 | Ci | <LLD | <LLD | <LLD | <LLD | <LLD |
| Xe-131m | Ci | <LLD | <LLD | <LLD | <LLD | <LLD |
| Xe-133 | Ci | 1.61E-02 | 2.07E-02 | 4.24E-02 | 1.72E-02 | 9.64E-02 |
| Xe-133m | Ci | <LLD | <LLD | <LLD | <LLD | <LLD |
| Xe-135 | Ci | <LLD | <LLD | 2.40E-04 | <LLD | 2.40E-04 |
| Xe-135m | Ci | <LLD | <LLD | <LLD | <LLD | <LLD |
| Xe-138 | Ci | <LLD | <LLD | <LLD | <LLD | <LLD |

D. Iodine Releases

| | | | | | | |
|-------|----|---|---|---|---|---|
| I-131 | Ci | * | * | * | * | * |
| I-132 | Ci | * | * | * | * | * |
| I-133 | Ci | * | * | * | * | * |
| I-134 | Ci | * | * | * | * | * |
| I-135 | Ci | * | * | * | * | * |

* Value reported as Continuous Mode

BRAIDWOOD NUCLEAR POWER STATION
ANNUAL EFFLUENT REPORT FOR 2001
GAS RELEASES
UNIT 1 (Docket Number 50-456)
CONTINUOUS MODE

| Units | 1st Qtr | 2nd Qtr | 3rd Qtr | 4th Qtr | Total |
|-------|---------|---------|---------|---------|-------|
|-------|---------|---------|---------|---------|-------|

A. Particulate (> 8 day half-life) Releases

| | | | | | | |
|----------|----|------|----------|------|------|----------|
| Cr-51 | Ci | <LLD | <LLD | <LLD | <LLD | <LLD |
| Mn-54 | Ci | <LLD | <LLD | <LLD | <LLD | <LLD |
| Co-57 | Ci | <LLD | <LLD | <LLD | <LLD | <LLD |
| Co-58 | Ci | <LLD | <LLD | <LLD | <LLD | <LLD |
| Fe-59 | Ci | <LLD | <LLD | <LLD | <LLD | <LLD |
| Co-60 | Ci | <LLD | <LLD | <LLD | <LLD | <LLD |
| An-65 | Ci | <LLD | <LLD | <LLD | <LLD | <LLD |
| Sr-89 | Ci | <LLD | <LLD | <LLD | <LLD | <LLD |
| Sr-90 | Ci | <LLD | <LLD | <LLD | <LLD | <LLD |
| Mo-99 | Ci | <LLD | <LLD | <LLD | <LLD | <LLD |
| Sn-117m | Ci | <LLD | 1.70E-07 | <LLD | <LLD | 1.70E-07 |
| Cs-134 | Ci | <LLD | <LLD | <LLD | <LLD | <LLD |
| Cs-137 | Ci | <LLD | <LLD | <LLD | <LLD | <LLD |
| BaLa-140 | Ci | <LLD | <LLD | <LLD | <LLD | <LLD |
| Ce-141 | Ci | <LLD | <LLD | <LLD | <LLD | <LLD |
| Ce-144 | Ci | <LLD | <LLD | <LLD | <LLD | <LLD |

B. Tritium Releases

| | | | | | | |
|---------------------------|----|----------|----------|----------|----------|----------|
| I. Total Release Activity | Ci | 3.13E+01 | 1.15E+01 | 1.28E+00 | 9.09E-01 | 4.50E+01 |
|---------------------------|----|----------|----------|----------|----------|----------|

C. Fission and Activation Gas Releases

| | | | | | | |
|---------|----|------|------|------|------|------|
| Ar-41 | Ci | <LLD | <LLD | <LLD | <LLD | <LLD |
| Kr-85 | Ci | <LLD | <LLD | <LLD | <LLD | <LLD |
| Kr-85m | Ci | <LLD | <LLD | <LLD | <LLD | <LLD |
| Kr-87 | Ci | <LLD | <LLD | <LLD | <LLD | <LLD |
| Kr-88 | Ci | <LLD | <LLD | <LLD | <LLD | <LLD |
| Xe-131m | Ci | <LLD | <LLD | <LLD | <LLD | <LLD |
| Xe-133 | Ci | <LLD | <LLD | <LLD | <LLD | <LLD |
| Xe-133m | Ci | <LLD | <LLD | <LLD | <LLD | <LLD |
| Xe-135 | Ci | <LLD | <LLD | <LLD | <LLD | <LLD |
| Xe-135m | Ci | <LLD | <LLD | <LLD | <LLD | <LLD |
| Xe-138 | Ci | <LLD | <LLD | <LLD | <LLD | <LLD |

D. Iodine Releases

| | | | | | | |
|-------|----|------|------|----------|----------|----------|
| I-131 | Ci | <LLD | <LLD | <LLD | 2.35E-06 | 2.35E-06 |
| I-132 | Ci | <LLD | <LLD | <LLD | <LLD | <LLD |
| I-133 | Ci | <LLD | <LLD | 1.94E-06 | <LLD | 1.94E-06 |
| I-134 | Ci | <LLD | <LLD | <LLD | <LLD | <LLD |
| I-135 | Ci | <LLD | <LLD | <LLD | <LLD | <LLD |

BRAIDWOOD NUCLEAR POWER STATION
ANNUAL EFFLUENT REPORT FOR 2001
GAS RELEASES
UNIT 2 (Docket Number 50-457)
SUMMATION OF ALL RELEASES

| Units | 1st Qtr | 2nd Qtr | 3rd Qtr | 4th Qtr | Total |
|-------|---------|---------|---------|---------|-------|
|-------|---------|---------|---------|---------|-------|

A. Fission and Activation Gas Releases

| | | | | | | |
|---------------------------|---------|----------|----------|----------|----------|-----------------|
| 1. Total Release Activity | Ci | 9.04E-02 | 8.43E-02 | 8.85E-02 | 1.17E-01 | 3.80E-01 |
| 2. Average Release Rate | uCi/sec | 1.16E-02 | 1.07E-02 | 1.11E-02 | 1.47E-02 | 1.20E-02 |

B. Iodine Releases

| | | | | | | |
|-------------------------|---------|------|------|------|------|----------------|
| 1. Total I-131 Activity | Ci | <LLD | <LLD | <LLD | <LLD | <LLD |
| 2. Average Release Rate | uCi/sec | <LLD | <LLD | <LLD | <LLD | <LLD |

C. Particulate (> 8 day half-life) Releases

| | | | | | | |
|-------------------------|---------|----------|------|------|----------|-----------------|
| 1. Gross Activity | Ci | 1.26E-06 | <LLD | <LLD | 4.85E-05 | 4.98E-05 |
| 2. Average Release Rate | uCi/sec | 1.62E-07 | <LLD | <LLD | 6.10E-06 | 1.58E-06 |
| 3. Gross Alpha Activity | Ci | <LLD | <LLD | <LLD | <LLD | <LLD |

D. Tritium Releases

| | | | | | | |
|---------------------------|---------|----------|----------|----------|----------|-----------------|
| 1. Total Release Activity | Ci | 3.52E+00 | 7.56E+00 | 2.25E+00 | 2.62E-02 | 1.34E+01 |
| 2. Average Release Rate | uCi/sec | 4.53E-01 | 9.62E-01 | 2.83E-01 | 3.30E-03 | 4.25E-01 |

**E. Sum of Iodine, Particulate (> 8 day half-life),
and Tritium Releases.**

| | | | | | | |
|---------------------------|----|----------|----------|----------|----------|-----------------|
| 1. Total Release Activity | Ci | 3.52E+00 | 7.56E+00 | 2.25E+00 | 2.62E-02 | 1.34E+01 |
|---------------------------|----|----------|----------|----------|----------|-----------------|

Note: LLD Values are included in Appendix A of this report.

Note: % Limit Values are included in Appendix B of this report.

BRAIDWOOD NUCLEAR POWER STATION
ANNUAL EFFLUENT REPORT FOR 2001
GAS RELEASES
UNIT 2 (Docket Number 50-457)
BATCH MODE

| Units | 1st Qtr | 2nd Qtr | 3rd Qtr | 4th Qtr | Total |
|-------|---------|---------|---------|---------|-------|
|-------|---------|---------|---------|---------|-------|

A. Particulate (> 8 day half-life) Releases

| | | | | | | |
|-----------|----|---|---|---|---|---|
| Cr-51 | Ci | * | * | * | * | * |
| Mn-54 | Ci | * | * | * | * | * |
| Co-57 | Ci | * | * | * | * | * |
| Co-58 | Ci | * | * | * | * | * |
| Fe-59 | Ci | * | * | * | * | * |
| Co-60 | Ci | * | * | * | * | * |
| Zn-65 | Ci | * | * | * | * | * |
| Sr-89 | Ci | * | * | * | * | * |
| Sr-90 | Ci | * | * | * | * | * |
| Mo-99 | Ci | * | * | * | * | * |
| Sn-117m | Ci | * | * | * | * | * |
| Cs-134 | Ci | * | * | * | * | * |
| Cs-137 | Ci | * | * | * | * | * |
| Ba/La-140 | Ci | * | * | * | * | * |
| Ce-141 | Ci | * | * | * | * | * |
| Ce-144 | Ci | * | * | * | * | * |

* Value reported as Continuous Mode

B. Tritium Releases

| | | | | | | |
|---------------------------|----|----------|----------|----------|----------|----------|
| 1. Total Release Activity | Ci | 3.86E-02 | 8.53E-02 | 1.54E-02 | 2.62E-02 | 1.66E-01 |
|---------------------------|----|----------|----------|----------|----------|----------|

C. Fission and Activation Gas Releases

| | | | | | | |
|---------|----|----------|----------|----------|----------|----------|
| Ar-41 | Ci | 4.66E-02 | 5.11E-02 | 6.09E-02 | 8.24E-02 | 2.41E-01 |
| Kr-85 | Ci | <LLD | <LLD | <LLD | <LLD | <LLD |
| Kr-85m | Ci | <LLD | <LLD | 3.52E-05 | <LLD | 3.52E-05 |
| Kr-87 | Ci | <LLD | <LLD | <LLD | <LLD | <LLD |
| Kr-88 | Ci | <LLD | <LLD | <LLD | <LLD | <LLD |
| Xe-131m | Ci | <LLD | <LLD | <LLD | <LLD | <LLD |
| Xe-133 | Ci | 4.07E-02 | 3.18E-02 | 2.73E-02 | 3.38E-02 | 1.34E-01 |
| Xe-133m | Ci | <LLD | <LLD | <LLD | <LLD | <LLD |
| Xe-135 | Ci | 3.10E-03 | 1.35E-03 | 2.43E-04 | 7.31E-04 | 5.42E-03 |
| Xe-135m | Ci | <LLD | <LLD | <LLD | <LLD | <LLD |
| Xe-138 | Ci | <LLD | <LLD | <LLD | <LLD | <LLD |

D. Iodine Releases

| | | | | | | |
|-------|---|---|---|---|---|---|
| I-131 | * | * | * | * | * | * |
| I-132 | * | * | * | * | * | * |
| I-133 | * | * | * | * | * | * |
| I-134 | * | * | * | * | * | * |
| I-135 | * | * | * | * | * | * |

* Value reported as Continuous Mode

BRAIDWOOD NUCLEAR POWER STATION
ANNUAL EFFLUENT REPORT FOR 2001
GAS RELEASES
UNIT 2 (Docket Number 50-457)
CONTINUOUS MODE

| Units | 1st Qtr | 2nd Qtr | 3rd Qtr | 4th Qtr | Total |
|-------|---------|---------|---------|---------|-------|
|-------|---------|---------|---------|---------|-------|

A. Particulate (> 8 day half-life) Releases

| | | | | | | |
|-----------|----|----------|------|------|----------|----------|
| Cr-51 | Ci | <LLD | <LLD | <LLD | <LLD | <LLD |
| Mn-54 | Ci | <LLD | <LLD | <LLD | <LLD | <LLD |
| Co-57 | Ci | <LLD | <LLD | <LLD | <LLD | <LLD |
| Co-58 | Ci | <LLD | <LLD | <LLD | 4.85E-05 | 4.85E-05 |
| Fe-59 | Ci | <LLD | <LLD | <LLD | <LLD | <LLD |
| Co-60 | Ci | <LLD | <LLD | <LLD | <LLD | <LLD |
| Zn-65 | Ci | <LLD | <LLD | <LLD | <LLD | <LLD |
| Sr-89 | Ci | <LLD | <LLD | <LLD | <LLD | <LLD |
| Sr-90 | Ci | <LLD | <LLD | <LLD | <LLD | <LLD |
| Mo-99 | Ci | <LLD | <LLD | <LLD | <LLD | <LLD |
| Sn-117m | Ci | 1.26E-06 | <LLD | <LLD | <LLD | 1.26E-06 |
| Cs-134 | Ci | <LLD | <LLD | <LLD | <LLD | <LLD |
| Cs-137 | Ci | <LLD | <LLD | <LLD | <LLD | <LLD |
| Ba\La-140 | Ci | <LLD | <LLD | <LLD | <LLD | <LLD |
| Ce-141 | Ci | <LLD | <LLD | <LLD | <LLD | <LLD |
| Ce-144 | Ci | <LLD | <LLD | <LLD | <LLD | <LLD |

B. Tritium Releases

| | | | | | | |
|---------------------------|----|----------|----------|----------|------|----------|
| 1. Total Release Activity | Ci | 3.48E+00 | 7.48E+00 | 2.23E+00 | <LLD | 1.32E+01 |
|---------------------------|----|----------|----------|----------|------|----------|

C. Fission and Activation Gas Releases

| | | | | | | |
|---------|----|------|------|------|------|------|
| Ar-41 | Ci | <LLD | <LLD | <LLD | <LLD | <LLD |
| Kr-85 | Ci | <LLD | <LLD | <LLD | <LLD | <LLD |
| Kr-85m | Ci | <LLD | <LLD | <LLD | <LLD | <LLD |
| Kr-87 | Ci | <LLD | <LLD | <LLD | <LLD | <LLD |
| Kr-88 | Ci | <LLD | <LLD | <LLD | <LLD | <LLD |
| Xe-131m | Ci | <LLD | <LLD | <LLD | <LLD | <LLD |
| Xe-133 | Ci | <LLD | <LLD | <LLD | <LLD | <LLD |
| Xe-133m | Ci | <LLD | <LLD | <LLD | <LLD | <LLD |
| Xe-135 | Ci | <LLD | <LLD | <LLD | <LLD | <LLD |
| Xe-135m | Ci | <LLD | <LLD | <LLD | <LLD | <LLD |
| Xe-138 | Ci | <LLD | <LLD | <LLD | <LLD | <LLD |

D. Iodine Releases

| | | | | | | |
|-------|----|------|------|------|------|------|
| I-131 | Ci | <LLD | <LLD | <LLD | <LLD | <LLD |
| I-132 | Ci | <LLD | <LLD | <LLD | <LLD | <LLD |
| I-133 | Ci | <LLD | <LLD | <LLD | <LLD | <LLD |
| I-134 | Ci | <LLD | <LLD | <LLD | <LLD | <LLD |
| I-135 | Ci | <LLD | <LLD | <LLD | <LLD | <LLD |

BRAIDWOOD NUCLEAR POWER STATION
 ANNUAL EFFLUENT REPORT FOR 2001
 LIQUID RELEASES
 UNIT 1 (Docket Number 50-456)
 SUMMATION OF ALL RELEASES

| Units | 1st Qtr | 2nd Qtr | 3rd Qtr | 4th Qtr | Total |
|-------|---------|---------|---------|---------|-------|
|-------|---------|---------|---------|---------|-------|

A. Fission and Activation Products

| | | | | | | |
|-----------------------------------|--------|----------|----------|----------|----------|-----------------|
| 1. Total Activity Released | Ci | 4.58E-03 | 2.19E-02 | 1.30E-02 | 1.60E-02 | 5.55E-02 |
| 2. Average Concentration Released | uCi/ml | 1.67E-09 | 9.35E-09 | 4.57E-09 | 5.37E-09 | 5.09E-09 |

B. Tritium

| | | | | | | |
|-----------------------------------|--------|----------|----------|----------|----------|-----------------|
| 1. Total Activity Released | Ci | 1.03E+02 | 3.42E+02 | 5.12E+02 | 4.16E+02 | 1.37E+03 |
| 2. Average Concentration Released | uCi/ml | 3.74E-05 | 1.46E-04 | 1.80E-04 | 1.40E-04 | 1.26E-04 |
| 3. % of Limit (1E-3 uCi/ml) | % | 3.74E+00 | 1.46E+01 | 1.80E+01 | 1.40E+01 | 1.26E+01 |

C. Dissolved Noble Gases

| | | | | | | |
|-----------------------------------|--------|----------|----------|----------|----------|-----------------|
| 1. Total Activity Released | Ci | 8.38E-05 | 2.96E-04 | 2.43E-03 | 5.85E-04 | 3.39E-03 |
| 2. Average Concentration Released | uCi/ml | 3.05E-11 | 1.26E-10 | 8.55E-10 | 1.96E-10 | 3.11E-10 |
| 3. % of Limit (2E-4 uCi/ml) | % | 1.53E-05 | 6.30E-05 | 4.28E-04 | 9.80E-05 | 1.56E-04 |

D. Gross Alpha

| | | | | | | |
|-----------------------------------|--------|----------|------|------|------|-----------------|
| 1. Total Activity Released | Ci | 1.85E-05 | <LLD | <LLD | <LLD | 1.85E-05 |
| 2. Average Concentration Released | uCi/ml | 6.73E-12 | <LLD | <LLD | <LLD | 1.70E-12 |

E. Volume of Releases

| | | | | | | |
|--|--------|----------|----------|----------|----------|-----------------|
| 1. Volume of Liquid Waste to Discharge | liters | 7.25E+05 | 1.06E+06 | 2.52E+06 | 1.87E+06 | 6.18E+06 |
| 2. Volume of Dilution Water | liters | 2.75E+09 | 2.34E+09 | 2.84E+09 | 2.98E+09 | 1.09E+10 |

Note: LLD Values are included in Appendix A of this report.

Note: % Limit Values are included in Appendix B of this report.

BRAIDWOOD NUCLEAR POWER STATION
ANNUAL EFFLUENT REPORT FOR 2001
LIQUID RELEASES
UNIT 1 (Docket Number 50-456)
BATCH MODE

| Nuclides From Batch Releases | Units | 1st Qtr | 2nd Qtr | 3rd Qtr | 4th Qtr | Total |
|------------------------------|-------|----------|----------|----------|----------|----------|
| H-3 | Ci | 9.85E+01 | 2.69E+02 | 4.58E+02 | 2.56E+02 | 1.08E+03 |
| Ar-41 | Ci | <LLD | <LLD | <LLD | <LLD | <LLD |
| Cr-51 | Ci | <LLD | 8.45E-05 | 5.35E-05 | 1.93E-04 | 3.31E-04 |
| Mn-54 | Ci | 7.87E-05 | 1.63E-04 | 2.00E-04 | 1.72E-04 | 6.14E-04 |
| Fe-55 | Ci | <LLD | 2.98E-04 | 8.90E-04 | 9.20E-04 | 2.11E-03 |
| Co-57 | Ci | <LLD | 4.93E-06 | 5.67E-06 | 3.50E-05 | 4.56E-05 |
| Co-58 | Ci | 1.29E-03 | 7.63E-04 | 1.03E-03 | 1.04E-02 | 1.35E-02 |
| Fe-59 | Ci | <LLD | <LLD | 9.75E-06 | <LLD | 9.75E-06 |
| Co-60 | Ci | 6.32E-04 | 2.38E-03 | 2.89E-03 | 4.42E-04 | 6.34E-03 |
| Ni-65 | Ci | <LLD | <LLD | <LLD | <LLD | <LLD |
| Zn-65 | Ci | <LLD | <LLD | <LLD | <LLD | <LLD |
| Kr-85 | Ci | <LLD | <LLD | 3.26E-04 | <LLD | 3.26E-04 |
| Kr-87 | Ci | <LLD | <LLD | <LLD | <LLD | <LLD |
| Kr-88 | Ci | <LLD | <LLD | <LLD | <LLD | <LLD |
| Sr-89 | Ci | <LLD | <LLD | <LLD | <LLD | <LLD |
| Sr-90 | Ci | <LLD | <LLD | <LLD | <LLD | <LLD |
| Nb-95 | Ci | <LLD | 2.83E-05 | <LLD | 5.10E-06 | 3.34E-05 |
| Zr-95 | Ci | <LLD | 1.47E-05 | <LLD | 4.59E-06 | 1.93E-05 |
| Nb-97 | Ci | 9.44E-06 | 2.53E-05 | 4.31E-06 | <LLD | 8.81E-05 |
| Zr-97 | Ci | <LLD | 7.20E-06 | <LLD | <LLD | 7.20E-06 |
| Tc-99m | Ci | <LLD | <LLD | <LLD | <LLD | <LLD |
| Mo-99 | Ci | <LLD | <LLD | <LLD | <LLD | <LLD |
| Ag-110m | Ci | 2.24E-05 | <LLD | <LLD | <LLD | 2.24E-05 |
| Sn-117m | Ci | <LLD | <LLD | 1.92E-06 | <LLD | 1.92E-06 |
| Sb-122 | Ci | <LLD | <LLD | 1.73E-06 | <LLD | 1.73E-06 |
| Te-123m | Ci | 1.73E-03 | 4.75E-04 | 8.84E-04 | 9.48E-04 | 4.04E-03 |
| Sb-124 | Ci | 4.27E-04 | 4.39E-04 | 4.46E-04 | 7.45E-06 | 1.32E-03 |
| Sb-125 | Ci | 3.18E-04 | 2.40E-03 | 4.96E-03 | 3.82E-04 | 8.06E-03 |
| Te-125m | Ci | <LLD | <LLD | 6.00E-04 | 2.48E-03 | 3.08E-03 |
| Xe-131m | Ci | <LLD | 8.85E-05 | <LLD | <LLD | 8.85E-05 |
| I-131 | Ci | <LLD | <LLD | <LLD | <LLD | <LLD |
| I-132 | Ci | 2.19E-05 | <LLD | <LLD | <LLD | 2.19E-05 |
| I-133 | Ci | <LLD | <LLD | <LLD | <LLD | <LLD |
| Xe-133 | Ci | 8.38E-05 | 2.08E-04 | 2.10E-03 | 5.56E-04 | 2.95E-03 |
| Xe-133m | Ci | <LLD | <LLD | <LLD | 2.86E-05 | 2.86E-05 |
| Cs-134 | Ci | 4.14E-06 | <LLD | <LLD | <LLD | 4.14E-06 |
| Xe-135 | Ci | <LLD | <LLD | 4.31E-06 | <LLD | 4.31E-06 |
| I-135 | Ci | <LLD | <LLD | <LLD | <LLD | <LLD |
| Cs-137 | Ci | 3.30E-05 | <LLD | 2.10E-04 | <LLD | 2.43E-04 |
| Cs-138 | Ci | <LLD | <LLD | <LLD | <LLD | <LLD |
| Xe-138 | Ci | <LLD | <LLD | <LLD | <LLD | <LLD |
| Ba/La-140 | Ci | <LLD | <LLD | <LLD | <LLD | <LLD |
| Ce-141 | Ci | <LLD | <LLD | <LLD | <LLD | <LLD |
| Ce-144 | Ci | 1.42E-05 | <LLD | <LLD | <LLD | 1.42E-05 |

BRAIDWOOD NUCLEAR POWER STATION
ANNUAL EFFLUENT REPORT FOR 2001
LIQUID RELEASES
UNIT 1 (Docket Number 50-456)
CONTINUOUS MODE

| Nuclides From Continuous Releases | Units | 1st Qtr | 2nd Qtr | 3rd Qtr | 4th Qtr | Total |
|-----------------------------------|-------|----------|----------|----------|----------|----------|
| H-3 | Ci | 4.92E+00 | 7.35E+01 | 5.40E+01 | 1.60E+02 | 2.92E+02 |
| Ar-41 | Ci | <LLD | <LLD | <LLD | <LLD | <LLD |
| Cr-51 | Ci | <LLD | <LLD | <LLD | <LLD | <LLD |
| Mn-54 | Ci | <LLD | <LLD | <LLD | <LLD | <LLD |
| Fe-55 | Ci | <LLD | <LLD | 8.55E-04 | <LLD | 8.55E-04 |
| Co-57 | Ci | <LLD | <LLD | <LLD | <LLD | <LLD |
| Co-58 | Ci | <LLD | <LLD | <LLD | <LLD | <LLD |
| Fe-59 | Ci | <LLD | <LLD | <LLD | <LLD | <LLD |
| Co-60 | Ci | <LLD | 1.48E-02 | <LLD | <LLD | 1.48E-02 |
| Ni-65 | Ci | <LLD | <LLD | <LLD | <LLD | <LLD |
| Zn-65 | Ci | <LLD | <LLD | <LLD | <LLD | <LLD |
| Kr-85 | Ci | <LLD | <LLD | <LLD | <LLD | <LLD |
| Kr-87 | Ci | <LLD | <LLD | <LLD | <LLD | <LLD |
| Kr-88 | Ci | <LLD | <LLD | <LLD | <LLD | <LLD |
| Sr-89 | Ci | <LLD | <LLD | <LLD | <LLD | <LLD |
| Sr-90 | Ci | <LLD | <LLD | <LLD | <LLD | <LLD |
| Nb-95 | Ci | <LLD | <LLD | <LLD | <LLD | <LLD |
| Zr-95 | Ci | <LLD | <LLD | <LLD | <LLD | <LLD |
| Nb-97 | Ci | <LLD | <LLD | <LLD | <LLD | <LLD |
| Zr-97 | Ci | <LLD | <LLD | <LLD | <LLD | <LLD |
| Tc-99m | Ci | <LLD | <LLD | <LLD | <LLD | <LLD |
| Mo-99 | Ci | <LLD | <LLD | <LLD | <LLD | <LLD |
| Ag-110m | Ci | <LLD | <LLD | <LLD | <LLD | <LLD |
| Sn-117m | Ci | <LLD | <LLD | <LLD | <LLD | <LLD |
| Sb-122 | Ci | <LLD | <LLD | <LLD | <LLD | <LLD |
| Te-123m | Ci | <LLD | <LLD | <LLD | <LLD | <LLD |
| Sb-124 | Ci | <LLD | <LLD | <LLD | <LLD | <LLD |
| Sb-125 | Ci | <LLD | <LLD | <LLD | <LLD | <LLD |
| Te-125m | Ci | <LLD | <LLD | <LLD | <LLD | <LLD |
| Xe-131m | Ci | <LLD | <LLD | <LLD | <LLD | <LLD |
| I-131 | Ci | <LLD | <LLD | <LLD | <LLD | <LLD |
| I-132 | Ci | <LLD | <LLD | <LLD | <LLD | <LLD |
| I-133 | Ci | <LLD | <LLD | <LLD | <LLD | <LLD |
| Xe-133 | Ci | <LLD | <LLD | <LLD | <LLD | <LLD |
| Xe-133m | Ci | <LLD | <LLD | <LLD | <LLD | <LLD |
| Cs-134 | Ci | <LLD | <LLD | <LLD | <LLD | <LLD |
| Xe-135 | Ci | <LLD | <LLD | <LLD | <LLD | <LLD |
| I-135 | Ci | <LLD | <LLD | <LLD | <LLD | <LLD |
| Cs-137 | Ci | <LLD | <LLD | <LLD | <LLD | <LLD |
| Cs-138 | Ci | <LLD | <LLD | <LLD | <LLD | <LLD |
| Xe-138 | Ci | <LLD | <LLD | <LLD | <LLD | <LLD |
| Ba/La-140 | Ci | <LLD | <LLD | <LLD | <LLD | <LLD |
| Ce-141 | Ci | <LLD | <LLD | <LLD | <LLD | <LLD |
| Ce-144 | Ci | 6.60E-07 | <LLD | <LLD | <LLD | 6.60E-07 |

BRAIDWOOD NUCLEAR POWER STATION
 ANNUAL EFFLUENT REPORT FOR 2001
 LIQUID RELEASES
 UNIT 2 (Docket Number 50-457)
 SUMMATION OF ALL RELEASES

| Units | 1st Qtr | 2nd Qtr | 3rd Qtr | 4th Qtr | Total |
|-------|---------|---------|---------|---------|-------|
|-------|---------|---------|---------|---------|-------|

A. Fission and Activation Products

| | | | | | | |
|-----------------------------------|--------|----------|----------|----------|----------|-----------------|
| 1. Total Activity Released | Ci | 4.58E-03 | 2.19E-02 | 1.30E-02 | 1.60E-02 | 5.55E-02 |
| 2. Average Concentration Released | uCi/ml | 1.67E-09 | 9.35E-09 | 4.57E-09 | 5.37E-09 | 5.09E-09 |

B. Tritium

| | | | | | | |
|-----------------------------------|--------|----------|----------|----------|----------|-----------------|
| 1. Total Activity Released | Ci | 1.03E+02 | 3.42E+02 | 5.12E+02 | 4.16E+02 | 1.37E+03 |
| 2. Average Concentration Released | uCi/ml | 3.74E-05 | 1.46E-04 | 1.80E-04 | 1.40E-04 | 1.26E-04 |
| 3. % of Limit (1E-3 uCi/ml) | % | 3.74E+00 | 1.46E+01 | 1.80E+01 | 1.40E+01 | 1.26E+01 |

C. Dissolved Noble Gases

| | | | | | | |
|-----------------------------------|--------|----------|----------|----------|----------|-----------------|
| 1. Total Activity Released | Ci | 8.38E-05 | 2.96E-04 | 2.43E-03 | 5.85E-04 | 3.39E-03 |
| 2. Average Concentration Released | uCi/ml | 3.05E-11 | 1.26E-10 | 8.55E-10 | 1.96E-10 | 3.11E-10 |
| 3. % of Limit (2E-4 uCi/ml) | % | 1.53E-05 | 6.30E-05 | 4.28E-04 | 9.80E-05 | 1.56E-04 |

D. Gross Alpha

| | | | | | | |
|-----------------------------------|--------|----------|------|------|------|-----------------|
| 1. Total Activity Released | Ci | 1.85E-05 | <LLD | <LLD | <LLD | 1.85E-05 |
| 2. Average Concentration Released | uCi/ml | 6.73E-12 | <LLD | <LLD | <LLD | 1.70E-12 |

E. Volume of Releases

| | | | | | | |
|--|--------|----------|----------|----------|----------|-----------------|
| 1. Volume of Liquid Waste to Discharge | liters | 7.25E+05 | 1.06E+06 | 2.52E+06 | 1.87E+06 | 6.18E+06 |
| 2. Volume of Dilution Water | liters | 2.75E+09 | 2.34E+09 | 2.84E+09 | 2.98E+09 | 1.09E+10 |

Note: LLD Values are included in Appendix A of this report.

Note: % Limit Values are included in Appendix B of this report.

BRAIDWOOD NUCLEAR POWER STATION
ANNUAL EFFLUENT REPORT FOR 2001
LIQUID RELEASES
UNIT 2 (Docket Number 50-457)
BATCH MODE

| Nuclides From Batch Releases | Units | 1st Qtr | 2nd Qtr | 3rd Qtr | 4th Qtr | Total |
|------------------------------|-------|----------|----------|----------|----------|----------|
| H-3 | Ci | 9.85E+01 | 2.69E+02 | 4.58E+02 | 2.56E+02 | 1.08E+03 |
| Ar-41 | Ci | <LLD | <LLD | <LLD | <LLD | <LLD |
| Cr-51 | Ci | <LLD | 8.45E-05 | 5.35E-05 | 1.93E-04 | 3.31E-04 |
| Mn-54 | Ci | 7.87E-05 | 1.63E-04 | 2.00E-04 | 1.72E-04 | 6.14E-04 |
| Fe-55 | Ci | <LLD | 2.98E-04 | 8.90E-04 | 9.20E-04 | 2.11E-03 |
| Co-57 | Ci | <LLD | 4.93E-06 | 5.67E-06 | 3.50E-05 | 4.56E-05 |
| Co-58 | Ci | 1.29E-03 | 7.63E-04 | 1.03E-03 | 1.04E-02 | 1.35E-02 |
| Fe-59 | Ci | <LLD | <LLD | 9.75E-06 | <LLD | 9.75E-06 |
| Co-60 | Ci | 6.32E-04 | 2.38E-03 | 2.89E-03 | 4.42E-04 | 6.34E-03 |
| Ni-65 | Ci | <LLD | <LLD | <LLD | <LLD | <LLD |
| Zn-65 | Ci | <LLD | <LLD | <LLD | <LLD | <LLD |
| Kr-85 | Ci | <LLD | <LLD | 3.26E-04 | <LLD | 3.26E-04 |
| Kr-87 | Ci | <LLD | <LLD | <LLD | <LLD | <LLD |
| Kr-88 | Ci | <LLD | <LLD | <LLD | <LLD | <LLD |
| Sr-89 | Ci | <LLD | <LLD | <LLD | <LLD | <LLD |
| Sr-90 | Ci | <LLD | <LLD | <LLD | <LLD | <LLD |
| Nb-95 | Ci | <LLD | 2.83E-05 | <LLD | 5.10E-06 | 3.34E-05 |
| Zr-95 | Ci | <LLD | 1.47E-05 | <LLD | 4.59E-06 | 1.93E-05 |
| Nb-97 | Ci | 9.44E-06 | 2.53E-05 | 4.31E-06 | <LLD | 8.81E-05 |
| Zr-97 | Ci | <LLD | 7.20E-06 | <LLD | <LLD | 7.20E-06 |
| Tc-99m | Ci | <LLD | <LLD | <LLD | <LLD | <LLD |
| Mo-99 | Ci | <LLD | <LLD | <LLD | <LLD | <LLD |
| Ag-110m | Ci | 2.24E-05 | <LLD | <LLD | <LLD | 2.24E-05 |
| Sn-117m | Ci | <LLD | <LLD | 1.92E-06 | <LLD | 1.92E-06 |
| Sb-122 | Ci | <LLD | <LLD | 1.73E-06 | <LLD | 1.73E-06 |
| Te-123m | Ci | 1.73E-03 | 4.75E-04 | 8.84E-04 | 9.48E-04 | 4.04E-03 |
| Sb-124 | Ci | 4.27E-04 | 4.39E-04 | 4.46E-04 | 7.45E-06 | 1.32E-03 |
| Sb-125 | Ci | 3.18E-04 | 2.40E-03 | 4.96E-03 | 3.82E-04 | 8.06E-03 |
| Te-125m | Ci | <LLD | <LLD | 6.00E-04 | 2.48E-03 | 3.08E-03 |
| Xe-131m | Ci | <LLD | 8.85E-05 | <LLD | <LLD | 8.85E-05 |
| I-131 | Ci | <LLD | <LLD | <LLD | <LLD | <LLD |
| I-132 | Ci | 2.19E-05 | <LLD | <LLD | <LLD | 2.19E-05 |
| I-133 | Ci | <LLD | <LLD | <LLD | <LLD | <LLD |
| Xe-133 | Ci | 8.38E-05 | 2.08E-04 | 2.10E-03 | 5.56E-04 | 2.95E-03 |
| Xe-133m | Ci | <LLD | <LLD | <LLD | 2.86E-05 | 2.86E-05 |
| Cs-134 | Ci | 4.14E-06 | <LLD | <LLD | <LLD | 4.14E-06 |
| Xe-135 | Ci | <LLD | <LLD | 4.31E-06 | <LLD | 4.31E-06 |
| I-135 | Ci | <LLD | <LLD | <LLD | <LLD | <LLD |
| Cs-137 | Ci | 3.30E-05 | <LLD | 2.10E-04 | <LLD | 2.43E-04 |
| Cs-138 | Ci | <LLD | <LLD | <LLD | <LLD | <LLD |
| Xe-138 | Ci | <LLD | <LLD | <LLD | <LLD | <LLD |
| Ba/La-140 | Ci | <LLD | <LLD | <LLD | <LLD | <LLD |
| Ce-141 | Ci | <LLD | <LLD | <LLD | <LLD | <LLD |
| Ce-144 | Ci | 1.42E-05 | <LLD | <LLD | <LLD | 1.42E-05 |

BRAIDWOOD NUCLEAR POWER STATION
ANNUAL EFFLUENT REPORT FOR 2001
LIQUID RELEASES
UNIT 2 (Docket Number 50-457)
CONTINUOUS MODE

| Nuclides From Continuous Releases | Units | 1st Qtr | 2nd Qtr | 3rd Qtr | 4th Qtr | Total |
|-----------------------------------|-------|----------|----------|----------|----------|----------|
| H-3 | Ci | 4.92E+00 | 7.35E+01 | 5.40E+01 | 1.60E+02 | 2.92E+02 |
| Ar-41 | Ci | <LLD | <LLD | <LLD | <LLD | <LLD |
| Cr-51 | Ci | <LLD | <LLD | <LLD | <LLD | <LLD |
| Mn-54 | Ci | <LLD | <LLD | <LLD | <LLD | <LLD |
| Fe-55 | Ci | <LLD | <LLD | 8.55E-04 | <LLD | 8.55E-04 |
| Co-57 | Ci | <LLD | <LLD | <LLD | <LLD | <LLD |
| Co-58 | Ci | <LLD | <LLD | <LLD | <LLD | <LLD |
| Fe-59 | Ci | <LLD | <LLD | <LLD | <LLD | <LLD |
| Co-60 | Ci | <LLD | 1.48E-02 | <LLD | <LLD | 1.48E-02 |
| Ni-65 | Ci | <LLD | <LLD | <LLD | <LLD | <LLD |
| Zn-65 | Ci | <LLD | <LLD | <LLD | <LLD | <LLD |
| Kr-85 | Ci | <LLD | <LLD | <LLD | <LLD | <LLD |
| Kr-87 | Ci | <LLD | <LLD | <LLD | <LLD | <LLD |
| Kr-88 | Ci | <LLD | <LLD | <LLD | <LLD | <LLD |
| Sr-89 | Ci | <LLD | <LLD | <LLD | <LLD | <LLD |
| Sr-90 | Ci | <LLD | <LLD | <LLD | <LLD | <LLD |
| Nb-95 | Ci | <LLD | <LLD | <LLD | <LLD | <LLD |
| Zr-95 | Ci | <LLD | <LLD | <LLD | <LLD | <LLD |
| Nb-97 | Ci | <LLD | <LLD | <LLD | <LLD | <LLD |
| Zr-97 | Ci | <LLD | <LLD | <LLD | <LLD | <LLD |
| Tc-99m | Ci | <LLD | <LLD | <LLD | <LLD | <LLD |
| Mo-99 | Ci | <LLD | <LLD | <LLD | <LLD | <LLD |
| Ag-110m | Ci | <LLD | <LLD | <LLD | <LLD | <LLD |
| Sn-117m | Ci | <LLD | <LLD | <LLD | <LLD | <LLD |
| Sb-122 | Ci | <LLD | <LLD | <LLD | <LLD | <LLD |
| Te-123m | Ci | <LLD | <LLD | <LLD | <LLD | <LLD |
| Sb-124 | Ci | <LLD | <LLD | <LLD | <LLD | <LLD |
| Sb-125 | Ci | <LLD | <LLD | <LLD | <LLD | <LLD |
| Te-125m | Ci | <LLD | <LLD | <LLD | <LLD | <LLD |
| Xe-131m | Ci | <LLD | <LLD | <LLD | <LLD | <LLD |
| I-131 | Ci | <LLD | <LLD | <LLD | <LLD | <LLD |
| I-132 | Ci | <LLD | <LLD | <LLD | <LLD | <LLD |
| I-133 | Ci | <LLD | <LLD | <LLD | <LLD | <LLD |
| Xe-133 | Ci | <LLD | <LLD | <LLD | <LLD | <LLD |
| Xe-133m | Ci | <LLD | <LLD | <LLD | <LLD | <LLD |
| Cs-134 | Ci | <LLD | <LLD | <LLD | <LLD | <LLD |
| Xe-135 | Ci | <LLD | <LLD | <LLD | <LLD | <LLD |
| I-135 | Ci | <LLD | <LLD | <LLD | <LLD | <LLD |
| Cs-137 | Ci | <LLD | <LLD | <LLD | <LLD | <LLD |
| Cs-138 | Ci | <LLD | <LLD | <LLD | <LLD | <LLD |
| Xe-138 | Ci | <LLD | <LLD | <LLD | <LLD | <LLD |
| BaLa-140 | Ci | <LLD | <LLD | <LLD | <LLD | <LLD |
| Ce-141 | Ci | <LLD | <LLD | <LLD | <LLD | <LLD |
| Ce-144 | Ci | 6.60E-07 | <LLD | <LLD | <LLD | 6.60E-07 |

BRAIDWOOD NUCLEAR POWER STATION
 RADIOACTIVE EFFLUENT RELEASE REPORT FOR 2001
 SOLID RADIOACTIVE WASTE
 UNIT 1 AND 2 COMBINED (Docket Numbers 50-456 and 50-457)

A. SOLID WASTE SHIPPED OFFSITE FOR BURIAL OR DISPOSAL

1. Types of Waste

| a. Process Waste | 1st Qtr | 2nd Qtr | 3rd Qtr | 4th Qtr | Yr total |
|---------------------------|----------|----------|----------|----------|----------|
| Total (m ³) = | 3.41E+00 | 1.00E+02 | 5.87E+00 | 1.17E+01 | 1.21E+02 |
| Total (Ci) = | 3.68E+01 | 2.68E+02 | 5.58E+00 | 1.74E+01 | 3.27E+02 |
| % Error = | 2.50E+01 | 2.50E+01 | 2.50E+01 | 2.50E+01 | 2.50E+01 |

| b. Dry Active Waste | 1st Qtr | 2nd Qtr | 3rd Qtr | 4th Qtr | Yr total |
|---------------------------|----------|----------|----------|----------|----------|
| Total (m ³) = | 3.82E+01 | 8.94E+01 | 0.00E+00 | 7.65E+01 | 2.04E+02 |
| Total (Ci) = | 1.54E-01 | 3.36E-02 | 0.00E+00 | 4.26E-01 | 6.14E-01 |
| % Error = | 2.50E+01 | 2.50E+01 | | 2.50E+01 | 2.50E+01 |

| c. Other Waste | 1st Qtr | 2nd Qtr | 3rd Qtr | 4th Qtr | Yr total |
|---------------------------|----------|----------|----------|----------|----------|
| Total (m ³) = | 8.25E+02 | 7.82E+02 | 0.00E+00 | 0.00E+00 | 1.61E+03 |
| Total (Ci) = | 4.26E+00 | 2.73E+00 | 0.00E+00 | 0.00E+00 | 6.98E+00 |
| % Error = | 2.50E+01 | 2.50E+01 | | | 2.50E+01 |

2. Estimate of major nuclide composition (by type of waste)

a. Process Waste

| Nuclide | 1st Qtr | 2nd Qtr | 3rd Qtr | 4th Qtr | Yr total | % Composition |
|---------|----------|----------|----------|----------|----------|---------------|
| | Ci | Ci | Ci | Ci | Ci | |
| *Fe-55 | 9.43E+00 | 8.26E+01 | 1.03E+00 | 6.23E+00 | 9.92E+01 | 3.03E+01 |
| *Ni-63 | 1.76E+01 | 7.43E+01 | 9.07E-01 | 5.52E+00 | 9.83E+01 | 3.00E+01 |
| Co-60 | 8.28E+00 | 4.90E+01 | 6.05E-01 | 3.68E+00 | 6.15E+01 | 1.88E+01 |
| Co-58 | 1.95E-02 | 2.71E+01 | 2.70E+00 | 5.63E-01 | 3.04E+01 | 9.28E+00 |
| Mn-54 | 7.38E-02 | 1.81E+01 | 4.62E-02 | 2.27E-01 | 1.85E+01 | 5.65E+00 |
| Cs-137 | 3.17E-02 | 5.72E+00 | 2.90E-02 | 3.06E-02 | 5.81E+00 | 1.77E+00 |
| *C-14 | 8.01E-01 | 3.29E+00 | 3.98E-02 | 2.42E-01 | 4.37E+00 | 1.34E+00 |
| Sb-125 | 1.56E-01 | 2.51E+00 | 3.11E-02 | 3.01E-01 | 3.00E+00 | 9.17E-01 |
| Co-57 | 9.87E-03 | 1.81E+00 | 4.12E-02 | 4.07E-02 | 1.91E+00 | 5.82E-01 |
| *Ni-59 | 2.06E-01 | 7.36E-01 | 8.93E-03 | 5.43E-02 | 1.01E+00 | 3.07E-01 |
| Be-7 | 0.00E+00 | 9.78E-01 | 0.00E+00 | 0.00E+00 | 9.78E-01 | 2.99E-01 |
| Cs-134 | 2.97E-03 | 8.80E-01 | 7.30E-04 | 3.47E-03 | 8.87E-01 | 2.71E-01 |
| H-3 | 1.35E-01 | 6.13E-02 | 1.15E-01 | 4.43E-01 | 7.54E-01 | 2.30E-01 |
| Sb-124 | 8.67E-04 | 4.10E-01 | 3.83E-03 | 2.13E-02 | 4.36E-01 | 1.33E-01 |

*Activities based on 10CFR61 scaling factors

b. Dry Active Waste

| Nuclide | 1st Qtr Ci | 2nd Qtr Ci | 3rd Qtr Ci | 4th Qtr Ci | Yr total Ci | % Composition |
|---------|---------------|---------------|---------------|---------------|----------------|---------------|
| *Fe-55 | 5.33E-02 | 6.27E-03 | 0.00E+00 | 1.38E-01 | 1.98E-01 | 3.22E+01 |
| *Ni-63 | 3.66E-02 | 4.28E-03 | 0.00E+00 | 1.18E-01 | 1.59E-01 | 2.59E+01 |
| Co-60 | 2.86E-02 | 3.36E-03 | 0.00E+00 | 8.00E-02 | 1.12E-01 | 1.82E+01 |
| Co-58 | 1.48E-02 | 1.89E-03 | 0.00E+00 | 3.26E-02 | 4.93E-02 | 8.03E+00 |
| H-3 | 1.09E-02 | 1.66E-02 | 0.00E+00 | 2.12E-02 | 4.87E-02 | 7.94E+00 |
| Nb-95 | 1.93E-03 | 2.73E-04 | 0.00E+00 | 7.55E-03 | 9.75E-03 | 1.59E+00 |
| Mn-54 | 2.66E-03 | 3.17E-04 | 0.00E+00 | 4.84E-03 | 7.82E-03 | 1.27E+00 |
| *C-14 | 1.62E-03 | 1.89E-04 | 0.00E+00 | 5.18E-03 | 6.99E-03 | 1.14E+00 |
| Cs-137 | 3.24E-04 | 3.79E-05 | 0.00E+00 | 5.03E-03 | 5.39E-03 | 8.79E-01 |
| Zr-95 | 1.01E-03 | 1.31E-04 | 0.00E+00 | 4.13E-03 | 5.27E-03 | 8.59E-01 |
| Sb-125 | 1.05E-03 | 1.23E-04 | 0.00E+00 | 3.62E-03 | 4.79E-03 | 7.81E-01 |
| Cr-51 | 0.00E+00 | 0.00E+00 | 0.00E+00 | 2.08E-03 | 2.08E-03 | 3.39E-01 |
| *Ni-59 | 4.16E-04 | 4.85E-05 | 0.00E+00 | 1.17E-03 | 1.63E-03 | 2.66E-01 |
| Co-57 | 2.19E-04 | 2.61E-05 | 0.00E+00 | 4.92E-04 | 7.37E-04 | 1.20E-01 |
| Sb-124 | 0.00E+00 | 0.00E+00 | 0.00E+00 | 7.12E-04 | 7.12E-04 | 1.16E-01 |

c. Other Waste

| Nuclide | 1st Qtr Ci | 2nd Qtr Ci | 3rd Qtr Ci | 4th Qtr Ci | Yr total Ci | % Composition |
|---------|---------------|---------------|---------------|---------------|----------------|---------------|
| *Ni-63 | 1.49E+00 | 9.53E-01 | 0.00E+00 | 0.00E+00 | 2.44E+00 | 3.50E+01 |
| *Fe-55 | 9.85E-01 | 6.31E-01 | 0.00E+00 | 0.00E+00 | 1.62E+00 | 2.31E+01 |
| Co-58 | 8.71E-01 | 5.57E-01 | 0.00E+00 | 0.00E+00 | 1.43E+00 | 2.05E+01 |
| Co-60 | 6.81E-01 | 4.37E-01 | 0.00E+00 | 0.00E+00 | 1.12E+00 | 1.60E+01 |
| *Ni-59 | 9.57E-02 | 6.13E-02 | 0.00E+00 | 0.00E+00 | 1.57E-01 | 2.25E+00 |
| Mn-54 | 2.77E-02 | 1.77E-02 | 0.00E+00 | 0.00E+00 | 4.54E-02 | 6.51E-01 |
| Nb-95 | 2.19E-02 | 1.39E-02 | 0.00E+00 | 0.00E+00 | 3.58E-02 | 5.13E-01 |
| Cr-51 | 2.04E-02 | 1.30E-02 | 0.00E+00 | 0.00E+00 | 3.34E-02 | 4.79E-01 |
| *C-14 | 1.71E-02 | 1.09E-02 | 0.00E+00 | 0.00E+00 | 2.80E-02 | 4.02E-01 |
| Co-57 | 1.51E-02 | 9.66E-03 | 0.00E+00 | 0.00E+00 | 2.48E-02 | 3.55E-01 |
| Sb-125 | 1.20E-02 | 7.70E-03 | 0.00E+00 | 0.00E+00 | 1.97E-02 | 2.82E-01 |
| Zr-95 | 1.13E-02 | 7.20E-03 | 0.00E+00 | 0.00E+00 | 1.85E-02 | 2.65E-01 |

*Activities based on 10CFR61 scaling factors

Number of Shipments: 37

Mode of Transportation: Exclusive Use

Destination: Alaron Corporation; Wampum, Pennsylvania (26);
Allied Technology Group, Richland, Washington (1);
Barnwell Waste Management Facility, Barnwell, South Carolina (7)
Envirocare, Clive, Utah (1);
GTS Duratek, Oak Ridge, Tennessee (2);

B. IRRADIATED FUEL SHIPMENTS

No irradiated fuel shipments for January through December, 2001

BRAIDWOOD NUCLEAR POWER STATION
RADIOACTIVE EFFLUENT RELEASE REPORT FOR 2001
SOLID RADIOACTIVE WASTE
UNIT 1 AND 2 COMBINED (Docket Numbers 50-456 and 50-457)

| Shipment Number | Waste Class | Type of Container | Solidification Agent or Absorbent |
|-----------------|-------------|-------------------|-----------------------------------|
| RWS01-001 | C | STC | NONE |
| RWS01-002 | AU | STC | NONE |
| RWS01-003 | AU | STC | NONE |
| RWS01-004 | AU | STC | NONE |
| RWS01-005 | AU | STC | NONE |
| RWS01-006 | AU | STC | NONE |
| RWS01-007 | AU | STC | NONE |
| RWS01-008 | AU | STC | NONE |
| RWS01-009 | AU | STC | NONE |
| RWS01-010 | AU | STC | NONE |
| RWS01-011 | AU | STC | NONE |
| RWS01-012 | AU | STC | NONE |
| RWS01-013 | AU | STC | NONE |
| RWS01-014 | AU | STC | NONE |
| RWS01-015 | AU | STC | NONE |
| RWS01-016 | AU | STC | NONE |
| RWS01-017 | AU | STC | NONE |
| RWS01-018 | AU | STC | NONE |
| RWS01-019 | AU | STC | NONE |
| RWS01-020 | AU | STC | NONE |
| RWS01-021 | AU | STC | NONE |
| RWS01-022 | AU | STC | NONE |
| RWS01-023 | AU | STC | NONE |
| RWS01-024 | AU | STC | NONE |
| RWS01-025 | AU | STC | NONE |
| RWS01-026 | AU | STC | NONE |
| RWS01-027 | AU | STC | NONE |
| RWS01-028 | AU | STC | NONE |
| RWS01-029 | AU | STC | NONE |
| RWS01-030 | B | DOT 7A TYPE A | NONE |
| RWS01-031 | B | DOT 7A TYPE A | NONE |
| RWS01-032 | B | DOT 7A TYPE A | NONE |
| RWS01-033 | AU | STC | NONE |
| RWS01-034 | AU | STC | NONE |
| RWS01-035 | AS | STC | NONE |
| RWS01-036 | AU | STC | NONE |
| RWS01-037 | AU | STC | NONE |

BRAIDWOOD NUCLEAR POWER STATION
 RADIOACTIVE EFFLUENT RELEASE REPORT FOR 2001
 UNIT 1 AND 2 COMBINED (Docket Numbers 50-456 and 50-457)

1. There were no changes to the Braidwood Station Process Control Program in 2001.
2. There were no changes to the installed liquid, gaseous, or solid radwaste treatment systems in 2001.
3. There were no liquid holdup tanks or gas decay tanks which exceeded the limits addressed in the ODCM-RETS.
4. Pursuant to ODCM-RETS Section 12.6.2, the following is an explanation as to why the inoperability of liquid or gaseous effluent monitoring instrumentation was not corrected within the time specified in ODCM-RETS:

On 7/21/2001, the OPR02J Gas Decay Tank Effluent radiation monitor exceeded its 14-day RETS requirement. The monitor was declared inoperable at 1630 on 7/7/01 due to the loop seal for the inlet line of the radiation monitor being plugged, which caused water to backup in the discharge line. The monitor required draining and decontamination on numerous occasions. Once the draining and decontamination evolutions were completed, the remote pre-amp of the monitor was found to be acting erratic. There was no replacement part available on site, so a replacement pre-amp was expedited from the vendor. On 8/8/01 at 1839, the monitor was returned to service.

5. Error in Measurement -

The following is an estimate of the errors associated with effluent monitoring and analysis. The estimate is calculated using the square root of the sum of the squares methodology.

| <u>A. Gaseous Effluents</u> | <u>Est. Total Error %</u> |
|---|---------------------------|
| 1. Fission and Activation Gas Releases | 7.59 |
| 2. Iodine Releases | 33.2 |
| 3. Particulates (>8 day half life) Releases | 19.8 |
| 4. Tritium Releases | 8.07 |
| | |
| <u>B. Liquid Effluents</u> | <u>Est. Total Error %</u> |
| 1. Fission and Activation Products | 2.64 |
| 2. Tritium | 5.85 |
| 3. Dissolved Noble Gases | 2.64 |
| 4. Gross Alpha | 14.7 |
| 5. Volume of Liquid Waste to Discharge | 2.0 |
| 6. Volume of Dilution Water | 1.5 |

6. The following is a summary of the 2001 Revisions to the Commonwealth Edison Company (ComEd) Offsite Dose Calculation Manual (ODCM):

- Generic Section
There were no changes to the generic section in 2001.
- Site Specific Annexes

Chapter 10, Revision 3

| <u>Section</u> | <u>Description of Change</u> |
|----------------|---|
| 10.1.2.4 | Deleted the description of a high alarm from the 2RE-PR027 initiating startup of the offgas treatment system. This interlock function for Unit 2 no longer exists due to the implementation of Modification D-20-2-96-308, "Abandonment of the Unit 2 Off-Gas Filter Unit." |
| Figure 10-1 | Indicated that the offgas filter unit operates for Unit 1 only when high radiation is detected in the offgas system effluent. This interlock function for Unit 2 no longer exists due to the implementation of Modification D-20-2-96-308, "Abandonment of the Unit 2 Off-Gas Filter Unit." |

Chapter 10, Revision 4

| <u>Section</u> | <u>Description of Change</u> |
|----------------|--|
| 10.1.2.4 | Deleted sentence "On high alarm 1RE-PR027 initiates startup of the offgas treatment system." Replaced with "No control devices are initiated by these channels." |
| Figure 10.1 | Deleted flowpath from the Unit 1 piping through the offgas system. |

Chapter 12, Revision 5

| <u>Section</u> | <u>Description of Change</u> |
|----------------|--|
| Definitions | Revised definitions for Dose Equivalent I-131 and Rated Thermal Power due to power uprate. |

Pursuant to Technical Specification 5.5.1, a copy of the entire ODCM is submitted as part of this report in Appendix C.

BRAIDWOOD NUCLEAR POWER STATION
RADIOACTIVE EFFLUENT RELEASE REPORT FOR 2001
UNIT 1 AND 2 (Docket Numbers 50-456 and 50-457)

APPENDIX A

LLD Tables

BRAIDWOOD NUCLEAR POWER STATION
 RADIOACTIVE EFFLUENT RELEASE REPORT FOR 2001
 UNIT 1 AND 2 (Docket Numbers 50-456 and 50-457)
 LLD VALUES FOR GASEOUS RELEASES

| <u>Isotope</u> | <u>LLD (Ci/ml)</u> |
|----------------|--------------------|
| Alpha | 2.23E-20 |
| H-3 | 4.50E-14 |
| Ar-41 | 5.61E-14 |
| Cr-51 | 1.36E-17 |
| Mn-54 | 2.24E-18 |
| Co-57 | 9.80E-19 |
| Co-58 | 1.95E-18 |
| Fe-59 | 3.64E-18 |
| Co-60 | 3.14E-18 |
| Zn-65 | 3.83E-18 |
| Kr-85 | 7.42E-12 |
| Kr-85m | 3.33E-14 |
| Kr-87 | 5.81E-12 |
| Kr-88 | 1.21E-11 |
| Sr-89 | 7.61E-22 |
| Sr-90 | 9.90E-23 |
| Mo-99 | 1.40E-18 |
| Sn-117m | 1.12E-18 |
| I-131 | 9.61E-19 |
| Xe-131m | 2.86E-13 |
| I-132 | 9.53E-16 |
| I-133 | 1.55E-18 |
| Xe-133 | 9.86E-12 |
| Xe-133m | 2.56E-11 |
| Cs-134 | 1.54E-18 |
| I-134 | 1.34E-17 |
| I-135 | 4.59E-17 |
| Xe-135 | 2.82E-12 |
| Xe-135m | 1.24E-11 |
| Cs-137 | 2.17E-18 |
| Xe-138 | 4.19E-11 |
| Ba-La-140 | 5.95E-18 |
| Ce-141 | 2.22E-18 |
| Ce-144 | 9.00E-18 |

NOTE: LLD Value for total activity released is based on LLD values for individual isotopes used in the calculation.

BRAIDWOOD NUCLEAR POWER STATION
 RADIOACTIVE EFFLUENT RELEASE REPORT FOR 2001
 UNIT 1 AND 2 (Docket Numbers 50-456 and 50-457)
 LLD VALUES FOR LIQUID RELEASES

| <u>Isotope</u> | <u>LLD (Ci/ml)</u> |
|----------------|--------------------|
| Alpha | 5.04E-14 |
| H-3 | 6.98E-12 |
| Ar-41 | 1.25E-13 |
| Cr-51 | 4.68E-13 |
| Mn-54 | 7.80E-14 |
| Fe-55 | 3.13E-13 |
| Co-57 | 3.81E-14 |
| Co-58 | 6.89E-14 |
| Fe-59 | 1.45E-13 |
| Co-60 | 7.90E-14 |
| Ni-65 | 4.11E-13 |
| Zn-65 | 1.31E-13 |
| As-76 | 8.45E-14 |
| Kr-85 | 8.76E-11 |
| Kr-87 | 1.60E-13 |
| Kr-88 | 2.03E-13 |
| Sr-89 | 2.01E-14 |
| Sr-90 | 2.21E-15 |
| Nb-95 | 6.04E-14 |
| Zr-97 | 3.54E-14 |
| Zr-95 | 1.09E-13 |
| Nb-97 | 8.85E-14 |
| Mo-99 | 2.77E-13 |
| Tc-99m | 3.55E-14 |
| Ag-110m | 4.43E-14 |
| Sn-117m | 4.54E-14 |
| Sb-122 | 5.19E-14 |
| Te-123m | 1.00E-13 |
| Sb-124 | 1.16E-14 |
| Sb-125 | 1.38E-13 |
| Te-125m | 1.47E-11 |
| I-131 | 1.12E-13 |
| Xe-131m | 1.56E-12 |
| I-133 | 5.47E-14 |
| Xe-133 | 1.73E-13 |
| Xe-133m | 4.59E-13 |
| Cs-134 | 5.28E-14 |
| Xe-135 | 5.70E-14 |
| Cs-137 | 5.24E-14 |
| Cs-138 | 1.65E-13 |
| Xe-138 | 1.60E-13 |
| Ba-La-140 | 1.88E-13 |
| Ce-141 | 1.08E-13 |
| Ce-144 | 3.75E-13 |

NOTE: LLD Value for Total Activity Released is based on LLD Values for individual isotopes used in the calculation.

BRAIDWOOD NUCLEAR POWER STATION
RADIOACTIVE EFFLUENT RELEASE REPORT FOR 2001
UNIT 1 AND 2 (Docket Numbers 50-456 and 50-457)

APPENDIX B

Supplemental Information

BRAIDWOOD NUCLEAR POWER STATION
RADIOACTIVE EFFLUENT RELEASE REPORT FOR 2001
UNIT 1 (Docket Number 50-456)

GASEOUS EFFLUENTS
SUPPLEMENTAL RELEASE INFORMATION

| A. Batch Release | 1st Qtr | 2nd Qtr | 3rd Qtr | 4th Qtr | Total |
|--|---------|---------|---------|---------|-------|
| 1. Total Number of Batch Releases | 36 | 37 | 42 | 28 | 143 |
| 2. Total Time Period for Batch Releases (minutes) | 2187 | 2336 | 4527 | 8603 | 17653 |
| 3. Maximum Time Period for a Batch Release (minutes) | 628 | 595 | 1049 | 3025 | 3025 |
| 4. Average Time Period for a Batch Release | 60.8 | 63.1 | 107.8 | 307.3 | 123.4 |
| 5. Minimum Time Period for a Batch Release (minutes) | 24 | 21 | 13 | 31 | 13 |
| B. Abnormal Releases | | | | | |
| 1. Number of Releases | 0 | 0 | 0 | 0 | 0 |
| 2. Total Activity Released | 0.00 | 0.00 | 0.00 | 0.00 | 0.00 |

BRAIDWOOD NUCLEAR POWER STATION
RADIOACTIVE EFFLUENT RELEASE REPORT FOR 2001
UNIT 2 (Docket Number 50-457)

GASEOUS EFFLUENTS
SUPPLEMENTAL RELEASE INFORMATION

| A. Batch Release | 1st Qtr | 2nd Qtr | 3rd Qtr | 4th Qtr | Total |
|--|---------|---------|---------|---------|-------|
| 1. Total Number of Batch Releases | 39 | 41 | 41 | 52 | 173 |
| 2. Total Time Period for Batch Releases (minutes) | 9368 | 7486 | 3033 | 4202 | 24089 |
| 3. Maximum Time Period for a Batch Release (minutes) | 964 | 1237 | 477 | 1520 | 1520 |
| 4. Average Time Period for a Batch Release | 240.2 | 182.6 | 74.0 | 80.8 | 139.2 |
| 5. Minimum Time Period for a Batch Release (minutes) | 16 | 20 | 24 | 24 | 16 |
| B. Abnormal Releases | | | | | |
| 1. Number of Releases | 0 | 0 | 0 | 0 | 0 |
| 2. Total Activity Released | 0.00 | 0.00 | 0.00 | 0.00 | 0.00 |

BRAIDWOOD NUCLEAR POWER STATION
 RADIOACTIVE EFFLUENT RELEASE REPORT FOR 2001
 UNIT COMMON (Docket Numbers 50-456 and 50-457)

GASEOUS EFFLUENTS (WASTE GAS DECAY TANKS)
 SUPPLEMENTAL RELEASE INFORMATION

| A. Batch Release | 1st Qtr | 2nd Qtr | 3rd Qtr | 4th Qtr | Total |
|--|---------|---------|---------|---------|-------|
| 1. Total Number of Batch Releases | 0 | 2 | 2 | 6 | 10 |
| 2. Total Time Period for Batch Releases (minutes) | N/A | 1576 | 192 | 415 | 2183 |
| 3. Maximum Time Period for a Batch Release (minutes) | N/A | 887 | 113 | 84 | 887 |
| 4. Average Time Period for a Batch Release | N/A | 788 | 96 | 69 | 218 |
| 5. Minimum Time Period for a Batch Release (minutes) | N/A | 689 | 79 | 45 | 45 |
| B. Abnormal Releases | | | | | |
| 1. Number of Releases | 0 | 0 | 0 | 0 | 0 |
| 2. Total Activity Released | 0.00 | 0.00 | 0.00 | 0.00 | 0.00 |

BRAIDWOOD NUCLEAR POWER STATION
RADIOACTIVE EFFLUENT RELEASE REPORT FOR 2001
UNIT 1 AND 2 COMBINED (Docket Numbers 50-456 and 50-457)
BRAIDWOOD NUCLEAR POWER STATION

LIQUID EFFLUENTS
SUPPLEMENTAL RELEASE INFORMATION

| A. Batch Release | 1st Qtr | 2nd Qtr | 3rd Qtr | 4th Qtr | Total |
|---|----------|----------|----------|----------|--------------|
| 1. Total Number of Batch Releases | 17 | 25 | 59 | 45 | 146 |
| 2. Total Time Period for Batch Releases (minutes) | 1877 | 4548 | 10323 | 10090 | 26838 |
| 3. Maximum Time Period for a Batch Release (minutes) | 312 | 450 | 410 | 500 | 500 |
| 4. Average Time Period for a Batch Release | 110 | 182 | 175 | 224 | 184 |
| 5. Minimum Time Period for a Batch Release (minutes) | 61 | 51 | 52 | 52 | 51 |
| 6. Average Stream Flow During Periods of Release of Effluent into a Flowing Stream (liters/min) | 1.55E+07 | 8.98E+06 | 2.69E+06 | 1.23E+07 | N/A |
| B. Abnormal Releases | | | | | |
| 1. Number of Releases | 0 | 0 | 0 | 0 | 0 |
| 2. Total Activity Released (Ci) | 0.00 | 0.00 | 0.00 | 0.00 | 0.00 |
| 3. Description | | | | | |

BRAIDWOOD STATION UNIT ONE

ACTUAL 2001

MAXIMUM DOSES RESULTING FROM AIRBORNE RELEASES

PERIOD OF RELEASE - 01/01/01 TO 12/31/01 CALCULATED 04/11/02
 INFANT RECEPTOR

| TYPE | 1ST QUARTER JAN-MAR | 2ND QUARTER APR-JUN | 3RD QUARTER JUL-SEP | 4TH QUARTER OCT-DEC | ANNUAL |
|---------------------|--|--|---------------------------|---------------------------|------------------|
| GAMMA AIR (MRAD) | 1.13E-05 (N) | 1.19E-05 (N) | 1.28E-05 (N) | 6.12E-06 (N) | 4.21E-05 (N) |
| BETA AIR (MRAD) | 8.79E-06 (N) | 9.41E-06 (N) | 1.07E-05 (N) | 5.04E-06 (N) | 3.40E-05 (N) |
| TOT. BODY (MREM) | 8.49E-06 (N) | 8.97E-06 (N) | 9.60E-06 (N) | 4.60E-06 (N) | 3.17E-05 (N) |
| SKIN (MREM) | 1.57E-05 (N) | 1.66E-05 (N) | 1.79E-05 (N) | 8.54E-06 (N) | 5.87E-05 (N) |
| ORGAN (MREM) | 5.90E-03 (N) | 2.20E-03 (N) | 4.57E-04 (N) | 2.21E-04 (N) | 8.78E-03 (N) |
| | LIVER THYROID KIDNEY LUNG GI_LLI | LIVER THYROID KIDNEY LUNG GI_LLI | THYROID | THYROID | THYROID |

THIS IS A REPORT FOR THE CALENDAR YEAR 2001

COMPLIANCE STATUS - 10CFR 50 APP. I
 INFANT RECEPTOR

----- % OF APP I. -----

| | QTRLY OBJ | 1ST QTR JAN-MAR | 2ND QTR APR-JUN | 3RD QTR JUL-SEP | 4TH QTR OCT-DEC | YRLY OBJ | % OF APP. I |
|------------------|--------------|--|--|--------------------|--------------------|-------------|----------------|
| GAMMA AIR (MRAD) | 5.0 | 0.00 | 0.00 | 0.00 | 0.00 | 10.0 | 0.00 |
| BETA AIR (MRAD) | 10.0 | 0.00 | 0.00 | 0.00 | 0.00 | 20.0 | 0.00 |
| TOT. BODY (MREM) | 2.5 | 0.00 | 0.00 | 0.00 | 0.00 | 5.0 | 0.00 |
| SKIN (MREM) | 7.5 | 0.00 | 0.00 | 0.00 | 0.00 | 15.0 | 0.00 |
| ORGAN (MREM) | 7.5 | 0.08 | 0.03 | 0.01 | 0.00 | 15.0 | 0.06 |
| | | LIVER THYROID KIDNEY LUNG GI_LLI | LIVER THYROID KIDNEY LUNG GI_LLI | THYROID | THYROID | | THYROID |

RESULTS BASED UPON:

ODCM ANNEX REVISION 2 DECEMBER 1996
 ODCM SOFTWARE VERSION 1.1 January 1995
 ODCM DATABASE VERSION 1.1 January 1995

BRAIDWOOD STATION UNIT ONE

ACTUAL 2001

MAXIMUM DOSES RESULTING FROM AIRBORNE RELEASES

PERIOD OF RELEASE - 01/01/01 TO 12/31/01 CALCULATED 04/11/02
CHILD RECEPTOR

| TYPE | 1ST QUARTER JAN-MAR | 2ND QUARTER APR-JUN | 3RD QUARTER JUL-SEP | 4TH QUARTER OCT-DEC | ANNUAL |
|---------------------|--|--|---------------------------|---------------------------|------------------|
| GAMMA AIR (MRAD) | 1.13E-05 (N) | 1.19E-05 (N) | 1.28E-05 (N) | 6.12E-06 (N) | 4.21E-05 (N) |
| BETA AIR (MRAD) | 8.79E-06 (N) | 9.41E-06 (N) | 1.07E-05 (N) | 5.04E-06 (N) | 3.40E-05 (N) |
| TOT. BODY (MREM) | 8.49E-06 (N) | 8.97E-06 (N) | 9.60E-06 (N) | 4.60E-06 (N) | 3.17E-05 (N) |
| SKIN (MREM) | 1.57E-05 (N) | 1.66E-05 (N) | 1.79E-05 (N) | 8.54E-06 (N) | 5.87E-05 (N) |
| ORGAN (MREM) | 6.27E-03 (N) | 6.00E-02 (N) | 1.79E-02 (N) | 7.69E-03 (N) | 9.19E-02 (N) |
| | LIVER THYROID KIDNEY LUNG GI_LLI | LIVER THYROID KIDNEY LUNG GI_LLI | THYROID | THYROID | THYROID |

THIS IS A REPORT FOR THE CALENDAR YEAR 2001

COMPLIANCE STATUS - 10CFR 50 APP. I
CHILD RECEPTOR

----- % OF APP I. -----

| | QTRLY OBJ | 1ST QTR JAN-MAR | 2ND QTR APR-JUN | 3RD QTR JUL-SEP | 4TH QTR OCT-DEC | YRLY OBJ | % OF APP. I |
|------------------|--------------|--|--|--------------------|--------------------|-------------|----------------|
| GAMMA AIR (MRAD) | 5.0 | 0.00 | 0.00 | 0.00 | 0.00 | 10.0 | 0.00 |
| BETA AIR (MRAD) | 10.0 | 0.00 | 0.00 | 0.00 | 0.00 | 20.0 | 0.00 |
| TOT. BODY (MREM) | 2.5 | 0.00 | 0.00 | 0.00 | 0.00 | 5.0 | 0.00 |
| SKIN (MREM) | 7.5 | 0.00 | 0.00 | 0.00 | 0.00 | 15.0 | 0.00 |
| ORGAN (MREM) | 7.5 | 0.08 | 0.80 | 0.24 | 0.10 | 15.0 | 0.61 |
| | | LIVER THYROID KIDNEY LUNG GI_LLI | LIVER THYROID KIDNEY LUNG GI_LLI | THYROID | THYROID | | THYROID |

RESULTS BASED UPON: ODCM ANNEX REVISION 2 DECEMBER 1996
ODCM SOFTWARE VERSION 1.1 January 1995
ODCM DATABASE VERSION 1.1 January 1995

BRAIDWOOD STATION UNIT ONE

ACTUAL 2001

MAXIMUM DOSES RESULTING FROM AIRBORNE RELEASES

PERIOD OF RELEASE - 01/01/01 TO 12/31/01 CALCULATED 04/11/02
TEENAGER RECEPTOR

| TYPE | 1ST QUARTER JAN-MAR | 2ND QUARTER APR-JUN | 3RD QUARTER JUL-SEP | 4TH QUARTER OCT-DEC | ANNUAL |
|---------------------|--|--|---------------------------|---------------------------|------------------|
| GAMMA AIR (MRAD) | 1.13E-05 (N) | 1.19E-05 (N) | 1.28E-05 (N) | 6.12E-06 (N) | 4.21E-05 (N) |
| BETA AIR (MRAD) | 8.79E-06 (N) | 9.41E-06 (N) | 1.07E-05 (N) | 5.04E-06 (N) | 3.40E-05 (N) |
| TOT. BODY (MREM) | 8.49E-06 (N) | 8.97E-06 (N) | 9.60E-06 (N) | 4.60E-06 (N) | 3.17E-05 (N) |
| SKIN (MREM) | 1.57E-05 (N) | 1.66E-05 (N) | 1.79E-05 (N) | 8.54E-06 (N) | 5.87E-05 (N) |
| ORGAN (MREM) | 4.93E-03 (N) | 3.91E-02 (N) | 1.16E-02 (N) | 4.99E-03 (N) | 6.06E-02 (N) |
| | LIVER THYROID KIDNEY LUNG GI_LLI | LIVER THYROID KIDNEY LUNG GI_LLI | THYROID | THYROID | THYROID |

THIS IS A REPORT FOR THE CALENDAR YEAR 2001

COMPLIANCE STATUS - 10CFR 50 APP. I
TEENAGER RECEPTOR

----- % OF APP I. -----

| | QTRLY OBJ | 1ST QTR JAN-MAR | 2ND QTR APR-JUN | 3RD QTR JUL-SEP | 4TH QTR OCT-DEC | YRLY OBJ | % OF APP. I |
|------------------|--------------|--|--|--------------------|--------------------|-------------|----------------|
| GAMMA AIR (MRAD) | 5.0 | 0.00 | 0.00 | 0.00 | 0.00 | 10.0 | 0.00 |
| BETA AIR (MRAD) | 10.0 | 0.00 | 0.00 | 0.00 | 0.00 | 20.0 | 0.00 |
| TOT. BODY (MREM) | 2.5 | 0.00 | 0.00 | 0.00 | 0.00 | 5.0 | 0.00 |
| SKIN (MREM) | 7.5 | 0.00 | 0.00 | 0.00 | 0.00 | 15.0 | 0.00 |
| ORGAN (MREM) | 7.5 | 0.07 | 0.52 | 0.16 | 0.07 | 15.0 | 0.40 |
| | | LIVER THYROID KIDNEY LUNG GI_LLI | LIVER THYROID KIDNEY LUNG GI_LLI | THYROID | THYROID | | THYROID |

RESULTS BASED UPON: ODCM ANNEX REVISION 2 DECEMBER 1996
ODCM SOFTWARE VERSION 1.1 January 1995
ODCM DATABASE VERSION 1.1 January 1995

BRAIDWOOD STATION UNIT ONE

ACTUAL 2001

MAXIMUM DOSES RESULTING FROM AIRBORNE RELEASES

PERIOD OF RELEASE - 01/01/01 TO 12/31/01 CALCULATED 04/11/02
ADULT RECEPTOR

| TYPE | 1ST QUARTER JAN-MAR | 2ND QUARTER APR-JUN | 3RD QUARTER JUL-SEP | 4TH QUARTER OCT-DEC | ANNUAL |
|---------------------|--|--|---------------------------|---------------------------|------------------|
| GAMMA AIR (MRAD) | 1.13E-05 (N) | 1.19E-05 (N) | 1.28E-05 (N) | 6.12E-06 (N) | 4.21E-05 (N) |
| BETA AIR (MRAD) | 8.79E-06 (N) | 9.41E-06 (N) | 1.07E-05 (N) | 5.04E-06 (N) | 3.40E-05 (N) |
| TOT. BODY (MREM) | 8.49E-06 (N) | 8.97E-06 (N) | 9.60E-06 (N) | 4.60E-06 (N) | 3.17E-05 (N) |
| SKIN (MREM) | 1.57E-05 (N) | 1.66E-05 (N) | 1.79E-05 (N) | 8.54E-06 (N) | 5.87E-05 (N) |
| ORGAN (MREM) | 6.39E-03 (NE) | 3.45E-02 (N) | 1.02E-02 (N) | 4.41E-03 (N) | 5.45E-02 (N) |
| | LIVER THYROID KIDNEY LUNG GI_LLI | LIVER THYROID KIDNEY LUNG GI_LLI | THYROID | THYROID | THYROID |

THIS IS A REPORT FOR THE CALENDAR YEAR 2001

COMPLIANCE STATUS - 10CFR 50 APP. I
ADULT RECEPTOR

----- % OF APP I. -----

| | QTRLY OBJ | 1ST QTR JAN-MAR | 2ND QTR APR-JUN | 3RD QTR JUL-SEP | 4TH QTR OCT-DEC | YRLY OBJ | % OF APP. I |
|------------------|--------------|--|--|--------------------|--------------------|-------------|----------------|
| GAMMA AIR (MRAD) | 5.0 | 0.00 | 0.00 | 0.00 | 0.00 | 10.0 | 0.00 |
| BETA AIR (MRAD) | 10.0 | 0.00 | 0.00 | 0.00 | 0.00 | 20.0 | 0.00 |
| TOT. BODY (MREM) | 2.5 | 0.00 | 0.00 | 0.00 | 0.00 | 5.0 | 0.00 |
| SKIN (MREM) | 7.5 | 0.00 | 0.00 | 0.00 | 0.00 | 15.0 | 0.00 |
| ORGAN (MREM) | 7.5 | 0.09 | 0.46 | 0.14 | 0.06 | 15.0 | 0.36 |
| | | LIVER THYROID KIDNEY LUNG GI_LLI | LIVER THYROID KIDNEY LUNG GI_LLI | THYROID | THYROID | | THYROID |

RESULTS BASED UPON: ODCM ANNEX REVISION 2 DECEMBER 1996
ODCM SOFTWARE VERSION 1.1 January 1995
ODCM DATABASE VERSION 1.1 January 1995

BRAIDWOOD STATION UNIT TWO

ACTUAL 2001
 MAXIMUM DOSES RESULTING FROM AIRBORNE RELEASES
 PERIOD OF RELEASE - 01/01/01 TO 12/31/01 CALCULATED 04/11/02
 INFANT RECEPTOR

| TYPE | 1ST QUARTER JAN-MAR | 2ND QUARTER APR-JUN | 3RD QUARTER JUL-SEP | 4TH QUARTER OCT-DEC | ANNUAL |
|---------------------|---------------------------|---------------------------|---------------------------|---------------------------|------------------|
| GAMMA AIR (MRAD) | 8.09E-06 (N) | 8.67E-06 (N) | 1.02E-05 (N) | 1.38E-05 (N) | 4.07E-05 (N) |
| BETA AIR (MRAD) | 7.42E-06 (N) | 7.45E-06 (N) | 8.35E-06 (N) | 1.12E-05 (N) | 3.44E-05 (N) |
| TOT. BODY (MREM) | 6.07E-06 (N) | 6.51E-06 (N) | 7.64E-06 (N) | 1.03E-05 (N) | 3.06E-05 (N) |
| SKIN (MREM) | 1.15E-05 (N) | 1.22E-05 (N) | 1.42E-05 (N) | 1.92E-05 (N) | 5.71E-05 (N) |
| ORGAN (MREM) | 6.57E-04 (N) | 1.42E-03 (N) | 4.23E-04 (N) | 1.59E-05 (N) | 2.52E-03 (N) |
| | LIVER | LIVER | LIVER | LUNG | LUNG |
| | THYROID | THYROID | THYROID | | |
| | KIDNEY | KIDNEY | KIDNEY | | |
| | LUNG | LUNG | LUNG | | |
| | GI_LLI | GI_LLI | GI_LLI | | |

THIS IS A REPORT FOR THE CALENDAR YEAR 2001

COMPLIANCE STATUS - 10CFR 50 APP. I
 INFANT RECEPTOR

----- % OF APP I. -----

| | QTRLY OBJ | 1ST QTR JAN-MAR | 2ND QTR APR-JUN | 3RD QTR JUL-SEP | 4TH QTR OCT-DEC | YRLY OBJ | % OF APP. I |
|------------------|--------------|--------------------|--------------------|--------------------|--------------------|-------------|----------------|
| GAMMA AIR (MRAD) | 5.0 | 0.00 | 0.00 | 0.00 | 0.00 | 10.0 | 0.00 |
| BETA AIR (MRAD) | 10.0 | 0.00 | 0.00 | 0.00 | 0.00 | 20.0 | 0.00 |
| TOT. BODY (MREM) | 2.5 | 0.00 | 0.00 | 0.00 | 0.00 | 5.0 | 0.00 |
| SKIN (MREM) | 7.5 | 0.00 | 0.00 | 0.00 | 0.00 | 15.0 | 0.00 |
| ORGAN (MREM) | 7.5 | 0.01 | 0.02 | 0.01 | 0.00 | 15.0 | 0.02 |
| | | LIVER | LIVER | LIVER | LUNG | | LUNG |
| | | THYROID | THYROID | THYROID | | | |
| | | KIDNEY | KIDNEY | KIDNEY | | | |
| | | LUNG | LUNG | LUNG | | | |
| | | GI_LLI | GI_LLI | GI_LLI | | | |

RESULTS BASED UPON: ODCM ANNEX REVISION 2 DECEMBER 1996
 ODCM SOFTWARE VERSION 1.1 January 1995
 ODCM DATABASE VERSION 1.1 January 1995

BRAIDWOOD STATION UNIT TWO

ACTUAL 2001

MAXIMUM DOSES RESULTING FROM AIRBORNE RELEASES

PERIOD OF RELEASE - 01/01/01 TO 12/31/01 CALCULATED 04/11/02

CHILD RECEPTOR

| TYPE | 1ST QUARTER JAN-MAR | 2ND QUARTER APR-JUN | 3RD QUARTER JUL-SEP | 4TH QUARTER OCT-DEC | ANNUAL |
|---------------------|---------------------------|---------------------------|---------------------------|---------------------------|------------------|
| GAMMA AIR (MRAD) | 8.09E-06 (N) | 8.67E-06 (N) | 1.02E-05 (N) | 1.38E-05 (N) | 4.07E-05 (N) |
| BETA AIR (MRAD) | 7.42E-06 (N) | 7.45E-06 (N) | 8.35E-06 (N) | 1.12E-05 (N) | 3.44E-05 (N) |
| TOT. BODY (MREM) | 6.07E-06 (N) | 6.51E-06 (N) | 7.64E-06 (N) | 1.03E-05 (N) | 3.06E-05 (N) |
| SKIN (MREM) | 1.15E-05 (N) | 1.22E-05 (N) | 1.42E-05 (N) | 1.92E-05 (N) | 5.71E-05 (N) |
| ORGAN (MREM) | 6.99E-04 (N) | 5.55E-02 (N) | 1.66E-02 (N) | 3.46E-05 (N) | 7.29E-02 (N) |
| | LIVER | LIVER | LIVER | LUNG | LUNG |
| | THYROID | THYROID | THYROID | | |
| | KIDNEY | KIDNEY | KIDNEY | | |
| | LUNG | LUNG | LUNG | | |
| | GI_LLI | GI_LLI | GI_LLI | | |

THIS IS A REPORT FOR THE CALENDAR YEAR 2001

COMPLIANCE STATUS - 10CFR 50 APP. I
CHILD RECEPTOR

----- % OF APP I. -----

| | QTRLY OBJ | 1ST QTR JAN-MAR | 2ND QTR APR-JUN | 3RD QTR JUL-SEP | 4TH QTR OCT-DEC | YRLY OBJ | % OF APP. I |
|------------------|--------------|--------------------|--------------------|--------------------|--------------------|-------------|----------------|
| GAMMA AIR (MRAD) | 5.0 | 0.00 | 0.00 | 0.00 | 0.00 | 10.0 | 0.00 |
| BETA AIR (MRAD) | 10.0 | 0.00 | 0.00 | 0.00 | 0.00 | 20.0 | 0.00 |
| TOT. BODY (MREM) | 2.5 | 0.00 | 0.00 | 0.00 | 0.00 | 5.0 | 0.00 |
| SKIN (MREM) | 7.5 | 0.00 | 0.00 | 0.00 | 0.00 | 15.0 | 0.00 |
| ORGAN (MREM) | 7.5 | 0.01 | 0.74 | 0.22 | 0.00 | 15.0 | 0.49 |
| | | LIVER | LIVER | LIVER | LUNG | | LUNG |
| | | THYROID | THYROID | THYROID | | | |
| | | KIDNEY | KIDNEY | KIDNEY | | | |
| | | LUNG | LUNG | LUNG | | | |
| | | GI_LLI | GI_LLI | GI_LLI | | | |

RESULTS BASED UPON:

ODCM ANNEX REVISION 2 DECEMBER 1996
ODCM SOFTWARE VERSION 1.1 January 1995
ODCM DATABASE VERSION 1.1 January 1995

BRAIDWOOD STATION UNIT TWO

ACTUAL 2001

MAXIMUM DOSES RESULTING FROM AIRBORNE RELEASES

PERIOD OF RELEASE - 01/01/01 TO 12/31/01 CALCULATED 04/11/02
TEENAGER RECEPTOR

| TYPE | 1ST QUARTER JAN-MAR | 2ND QUARTER APR-JUN | 3RD QUARTER JUL-SEP | 4TH QUARTER OCT-DEC | ANNUAL |
|---------------------|---------------------------|---------------------------|---------------------------|---------------------------|------------------|
| GAMMA AIR (MRAD) | 8.09E-06 (N) | 8.67E-06 (N) | 1.02E-05 (N) | 1.38E-05 (N) | 4.07E-05 (N) |
| BETA AIR (MRAD) | 7.42E-06 (N) | 7.45E-06 (N) | 8.35E-06 (N) | 1.12E-05 (N) | 3.44E-05 (N) |
| TOT. BODY (MREM) | 6.07E-06 (N) | 6.51E-06 (N) | 7.64E-06 (N) | 1.03E-05 (N) | 3.06E-05 (N) |
| SKIN (MREM) | 1.15E-05 (N) | 1.22E-05 (N) | 1.42E-05 (N) | 1.92E-05 (N) | 5.71E-05 (N) |
| ORGAN (MREM) | 5.49E-04 (N) | 3.61E-02 (N) | 1.08E-02 (N) | 2.76E-05 (N) | 4.74E-02 (N) |
| | LIVER | LIVER | LIVER | LUNG | LUNG |
| | THYROID | THYROID | THYROID | | |
| | KIDNEY | KIDNEY | KIDNEY | | |
| | LUNG | LUNG | LUNG | | |
| | GI_LLI | GI_LLI | GI_LLI | | |

THIS IS A REPORT FOR THE CALENDAR YEAR 2001

COMPLIANCE STATUS - 10CFR 50 APP. I
TEENAGER RECEPTOR

----- % OF APP I. -----

| | QTRLY OBJ | 1ST QTR JAN-MAR | 2ND QTR APR-JUN | 3RD QTR JUL-SEP | 4TH QTR OCT-DEC | YRLY OBJ | % OF APP. I |
|------------------|--------------|--------------------|--------------------|--------------------|--------------------|-------------|----------------|
| GAMMA AIR (MRAD) | 5.0 | 0.00 | 0.00 | 0.00 | 0.00 | 10.0 | 0.00 |
| BETA AIR (MRAD) | 10.0 | 0.00 | 0.00 | 0.00 | 0.00 | 20.0 | 0.00 |
| TOT. BODY (MREM) | 2.5 | 0.00 | 0.00 | 0.00 | 0.00 | 5.0 | 0.00 |
| SKIN (MREM) | 7.5 | 0.00 | 0.00 | 0.00 | 0.00 | 15.0 | 0.00 |
| ORGAN (MREM) | 7.5 | 0.01 | 0.48 | 0.14 | 0.00 | 15.0 | 0.32 |
| | | LIVER | LIVER | LIVER | LUNG | | LUNG |
| | | THYROID | THYROID | THYROID | | | |
| | | KIDNEY | KIDNEY | KIDNEY | | | |
| | | LUNG | LUNG | LUNG | | | |
| | | GI_LLI | GI_LLI | GI_LLI | | | |

RESULTS BASED UPON:

ODCM ANNEX REVISION 2 DECEMBER 1996
ODCM SOFTWARE VERSION 1.1 January 1995
ODCM DATABASE VERSION 1.1 January 1995

BRAIDWOOD STATION UNIT TWO

ACTUAL 2001
 MAXIMUM DOSES RESULTING FROM AIRBORNE RELEASES
 PERIOD OF RELEASE - 01/01/01 TO 12/31/01 CALCULATED 04/11/02
 ADULT RECEPTOR

| TYPE | 1ST QUARTER JAN-MAR | 2ND QUARTER APR-JUN | 3RD QUARTER JUL-SEP | 4TH QUARTER OCT-DEC | ANNUAL |
|---------------------|---------------------------|---------------------------|---------------------------|---------------------------|------------------|
| GAMMA AIR (MRAD) | 8.09E-06 (N) | 8.67E-06 (N) | 1.02E-05 (N) | 1.38E-05 (N) | 4.07E-05 (N) |
| BETA AIR (MRAD) | 7.42E-06 (N) | 7.45E-06 (N) | 8.35E-06 (N) | 1.12E-05 (N) | 3.44E-05 (N) |
| TOT. BODY (MREM) | 6.07E-06 (N) | 6.51E-06 (N) | 7.64E-06 (N) | 1.03E-05 (N) | 3.06E-05 (N) |
| SKIN (MREM) | 1.15E-05 (N) | 1.22E-05 (N) | 1.42E-05 (N) | 1.92E-05 (N) | 5.71E-05 (N) |
| ORGAN (MREM) | 7.12E-04 (NE) | 3.18E-02 (N) | 9.50E-03 (N) | 2.57E-05 (N) | 4.19E-02 (N) |
| | LIVER | LIVER | LIVER | LUNG | LUNG |
| | THYROID | THYROID | THYROID | | |
| | KIDNEY | KIDNEY | KIDNEY | | |
| | LUNG | LUNG | LUNG | | |
| | GI_LLI | GI_LLI | GI_LLI | | |

THIS IS A REPORT FOR THE CALENDAR YEAR 2001

COMPLIANCE STATUS - 10CFR 50 APP. I
 ADULT RECEPTOR

----- % OF APP I. -----

| | QTRLY OBJ | 1ST QTR JAN-MAR | 2ND QTR APR-JUN | 3RD QTR JUL-SEP | 4TH QTR OCT-DEC | YRLY OBJ | % OF APP. I |
|------------------|--------------|--------------------|--------------------|--------------------|--------------------|-------------|----------------|
| GAMMA AIR (MRAD) | 5.0 | 0.00 | 0.00 | 0.00 | 0.00 | 10.0 | 0.00 |
| BETA AIR (MRAD) | 10.0 | 0.00 | 0.00 | 0.00 | 0.00 | 20.0 | 0.00 |
| TOT. BODY (MREM) | 2.5 | 0.00 | 0.00 | 0.00 | 0.00 | 5.0 | 0.00 |
| SKIN (MREM) | 7.5 | 0.00 | 0.00 | 0.00 | 0.00 | 15.0 | 0.00 |
| ORGAN (MREM) | 7.5 | 0.01 | 0.42 | 0.13 | 0.00 | 15.0 | 0.28 |
| | | LIVER | LIVER | LIVER | LUNG | | LUNG |
| | | THYROID | THYROID | THYROID | | | |
| | | KIDNEY | KIDNEY | KIDNEY | | | |
| | | LUNG | LUNG | LUNG | | | |
| | | GI_LLI | GI_LLI | GI_LLI | | | |

RESULTS BASED UPON: ODCM ANNEX REVISION 2 DECEMBER 1996
 ODCM SOFTWARE VERSION 1.1 January 1995
 ODCM DATABASE VERSION 1.1 January 1995

BRAIDWOOD STATION UNIT ONE

ACTUAL 2001
 MAXIMUM DOSES (MREM) RESULTING FROM AQUATIC EFFLUENTS
 PERIOD OF RELEASE - 01/01/01 TO 12/31/01 CALCULATED 04/11/02
 INFANT RECEPTOR

| DOSE TYPE | 1ST QUARTER JAN-MAR | 2ND QUARTER APR-JUN | 3RD QUARTER JUL-SEP | 4TH QUARTER OCT-DEC | ANNUAL |
|-------------------|---------------------------|---------------------------|---------------------------|---------------------------|----------|
| TOTAL BODY | 1.18E-02 | 3.93E-02 | 5.85E-02 | 4.77E-02 | 1.57E-01 |
| INTERNAL ORGAN | 1.18E-02 | 3.93E-02 | 5.85E-02 | 4.77E-02 | 1.57E-01 |
| | LIVER | GI_LLI | LIVER | GI_LLI | GI_LLI |

THIS IS A REPORT FOR THE CALENDAR YEAR 2001

COMPLIANCE STATUS - 10 CFR 50 APP. I

----- % OF APP I. -----

| | QTRLY OBJ | 1ST QTR JAN-MAR | 2ND QTR APR-JUN | 3RD QTR JUL-SEP | 4TH QTR OCT-DEC | YRLY OBJ | % OF APP. I |
|--------------------|--------------|--------------------|--------------------|--------------------|--------------------|-------------|----------------|
| TOTAL BODY (MREM) | 1.5 | 0.79 | 2.62 | 3.90 | 3.18 | 3.0 | 5.24 |
| CRIT. ORGAN (MREM) | 5.0 | 0.24 | 0.79 | 1.17 | 0.95 | 10.0 | 1.57 |
| | | LIVER | GI_LLI | LIVER | GI_LLI | | GI_LLI |

RESULTS BASED UPON: ODCM ANNEX REVISION 2 DECEMBER 1996
 ODCM SOFTWARE VERSION 1.1 January 1995
 ODCM DATABASE VERSION 1.1 January 1995

BRAIDWOOD STATION UNIT ONE

2001 ANNUAL REPORT

PROJECTED DOSE AT NEAREST COMMUNITY WATER SYSTEM *

PERIOD OF RELEASE - 01/01/01 TO 12/31/01 CALCULATED 04/11/02
 INFANT RECEPTOR

| DOSE TYPE | 1ST QUARTER JAN-MAR | 2ND QUARTER APR-JUN | 3RD QUARTER JUL-SEP | 4TH QUARTER OCT-DEC | ANNUAL |
|------------------------------------|---------------------------|---------------------------|---------------------------|---------------------------|----------|
| TOTAL BODY INTERNAL ORGAN | 1.18E-02 | 3.93E-02 | 5.85E-02 | 4.77E-02 | 1.57E-01 |
| | 1.18E-02 | 3.93E-02 | 5.85E-02 | 4.77E-02 | 1.57E-01 |
| | LIVER | GI_LLI | LIVER | GI_LLI | GI_LLI |

THIS IS A REPORT FOR THE CALENDAR YEAR 2001

COMPLIANCE STATUS - 40 CFR 141

| TYPE | ANNUAL LIMIT | % OF LIMIT |
|------------------------------------|--------------|------------|
| TOTAL BODY INTERNAL ORGAN | 4.0 MREM | 3.931 |
| | 4.0 MREM | 3.932 |
| | | GI_LLI |

* THIS CALCULATION OF DOSE IS BASED ON TECHNIQUES DESCRIBED IN THE COMMONWEALTH EDISON OFFSITE DOSE CALCULATION MANUAL. THESE TECHNIQUES DIFFER FROM THOSE DESCRIBED IN 40 CFR 141.

RESULTS BASED UPON: ODCM ANNEX REVISION 2 DECEMBER 1996
 ODCM SOFTWARE VERSION 1.1 January 1995
 ODCM DATABASE VERSION 1.1 January 1995

BRAIDWOOD STATION UNIT ONE

ACTUAL 2001
 MAXIMUM DOSES (MREM) RESULTING FROM AQUATIC EFFLUENTS
 PERIOD OF RELEASE - 01/01/01 TO 12/31/01 CALCULATED 04/11/02
 CHILD RECEPTOR

| DOSE TYPE | 1ST QUARTER JAN-MAR | 2ND QUARTER APR-JUN | 3RD QUARTER JUL-SEP | 4TH QUARTER OCT-DEC | ANNUAL |
|-------------------|---------------------------|---------------------------|---------------------------|---------------------------|----------|
| TOTAL BODY | 1.19E-02 | 3.97E-02 | 5.91E-02 | 4.81E-02 | 1.59E-01 |
| INTERNAL ORGAN | 1.20E-02 | 3.98E-02 | 5.93E-02 | 4.82E-02 | 1.59E-01 |
| | LIVER | GI_LLI | LIVER | GI_LLI | GI_LLI |

THIS IS A REPORT FOR THE CALENDAR YEAR 2001

COMPLIANCE STATUS - 10 CFR 50 APP. I

----- % OF APP I. -----

| | QTRLY OBJ | 1ST QTR JAN-MAR | 2ND QTR APR-JUN | 3RD QTR JUL-SEP | 4TH QTR OCT-DEC | YRLY OBJ | % OF APP. I |
|--------------------|--------------|--------------------|--------------------|--------------------|--------------------|-------------|----------------|
| TOTAL BODY (MREM) | 1.5 | 0.79 | 2.64 | 3.94 | 3.21 | 3.0 | 5.29 |
| CRIT. ORGAN (MREM) | 5.0 | 0.24 | 0.80 | 1.19 | 0.96 | 10.0 | 1.59 |
| | | LIVER | GI_LLI | LIVER | GI_LLI | | GI_LLI |

RESULTS BASED UPON: ODCM ANNEX REVISION 2 DECEMBER 1996
 ODCM SOFTWARE VERSION 1.1 January 1995
 ODCM DATABASE VERSION 1.1 January 1995

BRAIDWOOD STATION UNIT ONE

2001 ANNUAL REPORT

PROJECTED DOSE AT NEAREST COMMUNITY WATER SYSTEM *

PERIOD OF RELEASE - 01/01/01 TO 12/31/01 CALCULATED 04/11/02
CHILD RECEPTOR

| DOSE TYPE | 1ST QUARTER JAN-MAR | 2ND QUARTER APR-JUN | 3RD QUARTER JUL-SEP | 4TH QUARTER OCT-DEC | ANNUAL |
|------------------------------------|---------------------------|---------------------------|---------------------------|---------------------------|----------|
| TOTAL BODY INTERNAL ORGAN | 1.19E-02 | 3.95E-02 | 5.89E-02 | 4.79E-02 | 1.58E-01 |
| | 1.19E-02 | 3.96E-02 | 5.89E-02 | 4.80E-02 | 1.58E-01 |
| | GI_LLI | GI_LLI | GI_LLI | GI_LLI | GI_LLI |

THIS IS A REPORT FOR THE CALENDAR YEAR 2001

COMPLIANCE STATUS - 40 CFR 141

| TYPE | ANNUAL LIMIT | % OF LIMIT |
|------------------------------------|--------------|------------|
| TOTAL BODY INTERNAL ORGAN | 4.0 MREM | 3.954 |
| | 4.0 MREM | 3.960 |
| | | GI_LLI |

* THIS CALCULATION OF DOSE IS BASED ON TECHNIQUES DESCRIBED IN THE COMMONWEALTH EDISON OFFSITE DOSE CALCULATION MANUAL. THESE TECHNIQUES DIFFER FROM THOSE DESCRIBED IN 40 CFR 141.

RESULTS BASED UPON: ODCM ANNEX REVISION 2 DECEMBER 1996
ODCM SOFTWARE VERSION 1.1 January 1995
ODCM DATABASE VERSION 1.1 January 1995

BRAIDWOOD STATION UNIT ONE

ACTUAL 2001
 MAXIMUM DOSES (MREM) RESULTING FROM AQUATIC EFFLUENTS
 PERIOD OF RELEASE - 01/01/01 TO 12/31/01 CALCULATED 04/11/02
 TEENAGER RECEPTOR

| DOSE TYPE | 1ST QUARTER JAN-MAR | 2ND QUARTER APR-JUN | 3RD QUARTER JUL-SEP | 4TH QUARTER OCT-DEC | ANNUAL |
|------------------------------------|---------------------------|---------------------------|---------------------------|---------------------------|----------|
| TOTAL BODY INTERNAL ORGAN | 6.27E-03 | 2.08E-02 | 3.11E-02 | 2.52E-02 | 8.33E-02 |
| | 6.30E-03 | 2.13E-02 | 3.12E-02 | 2.54E-02 | 8.40E-02 |
| | LIVER | GI_LLI | LIVER | GI_LLI | GI_LLI |

THIS IS A REPORT FOR THE CALENDAR YEAR 2001

COMPLIANCE STATUS - 10 CFR 50 APP. I

----- % OF APP I. -----

| | QTRLY OBJ | 1ST QTR JAN-MAR | 2ND QTR APR-JUN | 3RD QTR JUL-SEP | 4TH QTR OCT-DEC | YRLY OBJ | % OF APP. I |
|--------------------|--------------|--------------------|--------------------|--------------------|--------------------|-------------|----------------|
| TOTAL BODY (MREM) | 1.5 | 0.42 | 1.39 | 2.07 | 1.68 | 3.0 | 2.78 |
| CRIT. ORGAN (MREM) | 5.0 | 0.13 | 0.43 | 0.62 | 0.51 | 10.0 | 0.84 |
| | | LIVER | GI_LLI | LIVER | GI_LLI | | GI_LLI |

RESULTS BASED UPON: ODCM ANNEX REVISION 2 DECEMBER 1996
 ODCM SOFTWARE VERSION 1.1 January 1995
 ODCM DATABASE VERSION 1.1 January 1995

BRAIDWOOD STATION UNIT ONE

2001 ANNUAL REPORT

PROJECTED DOSE AT NEAREST COMMUNITY WATER SYSTEM *

PERIOD OF RELEASE - 01/01/01 TO 12/31/01 CALCULATED 04/11/02

TEENAGER RECEPTOR

| DOSE TYPE | 1ST QUARTER JAN-MAR | 2ND QUARTER APR-JUN | 3RD QUARTER JUL-SEP | 4TH QUARTER OCT-DEC | ANNUAL |
|-----------|---------------------------|---------------------------|---------------------------|---------------------------|----------|
| TOTAL | 6.20E-03 | 2.06E-02 | 3.07E-02 | 2.50E-02 | 8.26E-02 |
| BODY | | | | | |
| INTERNAL | 6.22E-03 | 2.09E-02 | 3.08E-02 | 2.51E-02 | 8.30E-02 |
| ORGAN | GI_LLI | GI_LLI | GI_LLI | GI_LLI | GI_LLI |

THIS IS A REPORT FOR THE CALENDAR YEAR 2001

COMPLIANCE STATUS - 40 CFR 141

| TYPE | ANNUAL LIMIT | % OF LIMIT |
|----------|--------------|------------|
| TOTAL | 4.0 MREM | 2.064 |
| BODY | | |
| INTERNAL | 4.0 MREM | 2.076 |
| ORGAN | | |
| | | GI_LLI |

* THIS CALCULATION OF DOSE IS BASED ON TECHNIQUES DESCRIBED IN THE COMMONWEALTH EDISON OFFSITE DOSE CALCULATION MANUAL. THESE TECHNIQUES DIFFER FROM THOSE DESCRIBED IN 40 CFR 141.

RESULTS BASED UPON: ODCM ANNEX REVISION 2 DECEMBER 1996
 ODCM SOFTWARE VERSION 1.1 January 1995
 ODCM DATABASE VERSION 1.1 January 1995

BRAIDWOOD STATION UNIT ONE

ACTUAL 2001
 MAXIMUM DOSES (MREM) RESULTING FROM AQUATIC EFFLUENTS
 PERIOD OF RELEASE - 01/01/01 TO 12/31/01 CALCULATED 04/11/02
 ADULT RECEPTOR

| DOSE TYPE | 1ST QUARTER JAN-MAR | 2ND QUARTER APR-JUN | 3RD QUARTER JUL-SEP | 4TH QUARTER OCT-DEC | ANNUAL |
|-----------|---------------------------|---------------------------|---------------------------|---------------------------|----------|
| TOTAL | 4.54E-03 | 1.50E-02 | 2.25E-02 | 1.82E-02 | 6.02E-02 |
| BODY | | | | | |
| INTERNAL | 4.56E-03 | 1.55E-02 | 2.26E-02 | 1.84E-02 | 6.09E-02 |
| ORGAN | LIVER | GI_LLI | LIVER | GI_LLI | GI_LLI |

THIS IS A REPORT FOR THE CALENDAR YEAR 2001

COMPLIANCE STATUS - 10 CFR 50 APP. I

----- % OF APP I. -----

| | QTRLY OBJ | 1ST QTR JAN-MAR | 2ND QTR APR-JUN | 3RD QTR JUL-SEP | 4TH QTR OCT-DEC | YRLY OBJ | % OF APP. I |
|--------------------|--------------|--------------------|--------------------|--------------------|--------------------|-------------|----------------|
| TOTAL BODY (MREM) | 1.5 | 0.30 | 1.00 | 1.50 | 1.21 | 3.0 | 2.01 |
| CRIT. ORGAN (MREM) | 5.0 | 0.09 | 0.31 | 0.45 | 0.37 | 10.0 | 0.61 |
| | | LIVER | GI_LLI | LIVER | GI_LLI | | GI_LLI |

RESULTS BASED UPON: ODCM ANNEX REVISION 2 DECEMBER 1996
 ODCM SOFTWARE VERSION 1.1 January 1995
 ODCM DATABASE VERSION 1.1 January 1995

BRAIDWOOD STATION UNIT TWO

ACTUAL 2001
 MAXIMUM DOSES (MREM) RESULTING FROM AQUATIC EFFLUENTS
 PERIOD OF RELEASE - 01/01/01 TO 12/31/01 CALCULATED 04/11/02
 INFANT RECEPTOR

| DOSE TYPE | 1ST QUARTER JAN-MAR | 2ND QUARTER APR-JUN | 3RD QUARTER JUL-SEP | 4TH QUARTER OCT-DEC | ANNUAL |
|-------------------|---------------------------|---------------------------|---------------------------|---------------------------|----------|
| TOTAL BODY | 1.18E-02 | 3.93E-02 | 5.85E-02 | 4.77E-02 | 1.57E-01 |
| INTERNAL ORGAN | 1.18E-02 | 3.93E-02 | 5.85E-02 | 4.77E-02 | 1.57E-01 |
| | LIVER | GI_LLI | LIVER | GI_LLI | GI_LLI |

THIS IS A REPORT FOR THE CALENDAR YEAR 2001

COMPLIANCE STATUS - 10 CFR 50 APP. I

----- % OF APP I. -----

| | QTRLY OBJ | 1ST QTR JAN-MAR | 2ND QTR APR-JUN | 3RD QTR JUL-SEP | 4TH QTR OCT-DEC | YRLY OBJ | % OF APP. I |
|--------------------|--------------|--------------------|--------------------|--------------------|--------------------|-------------|----------------|
| TOTAL BODY (MREM) | 1.5 | 0.79 | 2.62 | 3.90 | 3.18 | 3.0 | 5.24 |
| CRIT. ORGAN (MREM) | 5.0 | 0.24 | 0.79 | 1.17 | 0.95 | 10.0 | 1.57 |
| | | LIVER | GI_LLI | LIVER | GI_LLI | | GI_LLI |

RESULTS BASED UPON: ODCM ANNEX REVISION 2 DECEMBER 1996
 ODCM SOFTWARE VERSION 1.1 January 1995
 ODCM DATABASE VERSION 1.1 January 1995

BRAIDWOOD STATION UNIT TWO

2001 ANNUAL REPORT

PROJECTED DOSE AT NEAREST COMMUNITY WATER SYSTEM *

PERIOD OF RELEASE - 01/01/01 TO 12/31/01 CALCULATED 04/11/02
 INFANT RECEPTOR

| DOSE TYPE | 1ST QUARTER JAN-MAR | 2ND QUARTER APR-JUN | 3RD QUARTER JUL-SEP | 4TH QUARTER OCT-DEC | ANNUAL |
|-----------|---------------------------|---------------------------|---------------------------|---------------------------|----------|
| TOTAL | 1.18E-02 | 3.93E-02 | 5.85E-02 | 4.77E-02 | 1.57E-01 |
| BODY | | | | | |
| INTERNAL | 1.18E-02 | 3.93E-02 | 5.85E-02 | 4.77E-02 | 1.57E-01 |
| ORGAN | LIVER | GI_LLI | LIVER | GI_LLI | GI_LLI |

THIS IS A REPORT FOR THE CALENDAR YEAR 2001

COMPLIANCE STATUS - 40 CFR 141

| TYPE | ANNUAL LIMIT | % OF LIMIT |
|----------|--------------|------------|
| TOTAL | 4.0 MREM | 3.931 |
| BODY | | |
| INTERNAL | 4.0 MREM | 3.932 |
| ORGAN | | |
| | | GI_LLI |

* THIS CALCULATION OF DOSE IS BASED ON TECHNIQUES DESCRIBED IN THE COMMONWEALTH EDISON OFFSITE DOSE CALCULATION MANUAL. THESE TECHNIQUES DIFFER FROM THOSE DESCRIBED IN 40 CFR 141.

RESULTS BASED UPON: ODCM ANNEX REVISION 2 DECEMBER 1996
 ODCM SOFTWARE VERSION 1.1 January 1995
 ODCM DATABASE VERSION 1.1 January 1995

BRAIDWOOD STATION UNIT TWO

ACTUAL 2001
 MAXIMUM DOSES (MREM) RESULTING FROM AQUATIC EFFLUENTS
 PERIOD OF RELEASE - 01/01/01 TO 12/31/01 CALCULATED 04/11/02
 CHILD RECEPTOR

| DOSE TYPE | 1ST QUARTER JAN-MAR | 2ND QUARTER APR-JUN | 3RD QUARTER JUL-SEP | 4TH QUARTER OCT-DEC | ANNUAL |
|-----------|---------------------------|---------------------------|---------------------------|---------------------------|----------|
| TOTAL | 1.19E-02 | 3.97E-02 | 5.91E-02 | 4.81E-02 | 1.59E-01 |
| BODY | | | | | |
| INTERNAL | 1.20E-02 | 3.98E-02 | 5.93E-02 | 4.82E-02 | 1.59E-01 |
| ORGAN | LIVER | GI_LLI | LIVER | GI_LLI | GI_LLI |

THIS IS A REPORT FOR THE CALENDAR YEAR 2001

COMPLIANCE STATUS - 10 CFR 50 APP. I

----- % OF APP I. -----

| | QTRLY OBJ | 1ST QTR JAN-MAR | 2ND QTR APR-JUN | 3RD QTR JUL-SEP | 4TH QTR OCT-DEC | YRLY OBJ | % OF APP. I |
|--------------------|--------------|--------------------|--------------------|--------------------|--------------------|-------------|----------------|
| TOTAL BODY (MREM) | 1.5 | 0.79 | 2.64 | 3.94 | 3.21 | 3.0 | 5.29 |
| CRIT. ORGAN (MREM) | 5.0 | 0.24 | 0.80 | 1.19 | 0.96 | 10.0 | 1.59 |
| | | LIVER | GI_LLI | LIVER | GI_LLI | | GI_LLI |

RESULTS BASED UPON: ODCM ANNEX REVISION 2 DECEMBER 1996
 ODCM SOFTWARE VERSION 1.1 January 1995
 ODCM DATABASE VERSION 1.1 January 1995

BRAIDWOOD STATION UNIT TWO

2001 ANNUAL REPORT

PROJECTED DOSE AT NEAREST COMMUNITY WATER SYSTEM *

PERIOD OF RELEASE - 01/01/01 TO 12/31/01 CALCULATED 04/11/02

CHILD RECEPTOR

| DOSE TYPE | 1ST QUARTER JAN-MAR | 2ND QUARTER APR-JUN | 3RD QUARTER JUL-SEP | 4TH QUARTER OCT-DEC | ANNUAL |
|---------------------------|---------------------------|---------------------------|---------------------------|---------------------------|----------|
| TOTAL | 1.19E-02 | 3.95E-02 | 5.89E-02 | 4.79E-02 | 1.58E-01 |
| BODY INTERNAL ORGAN | 1.19E-02 | 3.96E-02 | 5.89E-02 | 4.80E-02 | 1.58E-01 |
| | GI_LLI | GI_LLI | GI_LLI | GI_LLI | GI_LLI |

THIS IS A REPORT FOR THE CALENDAR YEAR 2001

COMPLIANCE STATUS - 40 CFR 141

| TYPE | ANNUAL LIMIT | % OF LIMIT |
|---------------------------|--------------|------------|
| TOTAL | 4.0 MREM | 3.954 |
| BODY INTERNAL ORGAN | 4.0 MREM | 3.960 |
| | | GI_LLI |

* THIS CALCULATION OF DOSE IS BASED ON TECHNIQUES DESCRIBED IN THE COMMONWEALTH EDISON OFFSITE DOSE CALCULATION MANUAL. THESE TECHNIQUES DIFFER FROM THOSE DESCRIBED IN 40 CFR 141.

RESULTS BASED UPON: ODCM ANNEX REVISION 2 DECEMBER 1996
 ODCM SOFTWARE VERSION 1.1 January 1995
 ODCM DATABASE VERSION 1.1 January 1995

BRAIDWOOD STATION UNIT TWO

ACTUAL 2001
 MAXIMUM DOSES (MREM) RESULTING FROM AQUATIC EFFLUENTS
 PERIOD OF RELEASE - 01/01/01 TO 12/31/01 CALCULATED 04/11/02
 TEENAGER RECEPTOR

| DOSE TYPE | 1ST QUARTER JAN-MAR | 2ND QUARTER APR-JUN | 3RD QUARTER JUL-SEP | 4TH QUARTER OCT-DEC | ANNUAL |
|-----------|---------------------------|---------------------------|---------------------------|---------------------------|----------|
| TOTAL | 6.27E-03 | 2.08E-02 | 3.11E-02 | 2.52E-02 | 8.33E-02 |
| BODY | | | | | |
| INTERNAL | 6.30E-03 | 2.13E-02 | 3.12E-02 | 2.54E-02 | 8.40E-02 |
| ORGAN | LIVER | GI_LLI | LIVER | GI_LLI | GI_LLI |

THIS IS A REPORT FOR THE CALENDAR YEAR 2001

COMPLIANCE STATUS - 10 CFR 50 APP. I

----- % OF APP I. -----

| | QTRLY OBJ | 1ST QTR JAN-MAR | 2ND QTR APR-JUN | 3RD QTR JUL-SEP | 4TH QTR OCT-DEC | YRLY OBJ | % OF APP. I |
|--------------------|--------------|--------------------|--------------------|--------------------|--------------------|-------------|----------------|
| TOTAL BODY (MREM) | 1.5 | 0.42 | 1.39 | 2.07 | 1.68 | 3.0 | 2.78 |
| CRIT. ORGAN (MREM) | 5.0 | 0.13 | 0.43 | 0.62 | 0.51 | 10.0 | 0.84 |
| | | LIVER | GI_LLI | LIVER | GI_LLI | | GI_LLI |

RESULTS BASED UPON: ODCM ANNEX REVISION 2 DECEMBER 1996
 ODCM SOFTWARE VERSION 1.1 January 1995
 ODCM DATABASE VERSION 1.1 January 1995

BRAIDWOOD STATION UNIT TWO

2001 ANNUAL REPORT

PROJECTED DOSE AT NEAREST COMMUNITY WATER SYSTEM *

PERIOD OF RELEASE - 01/01/01 TO 12/31/01 CALCULATED 04/11/02

TEENAGER RECEPTOR

| DOSE TYPE | 1ST QUARTER JAN-MAR | 2ND QUARTER APR-JUN | 3RD QUARTER JUL-SEP | 4TH QUARTER OCT-DEC | ANNUAL |
|---------------------------|---------------------------|---------------------------|---------------------------|---------------------------|----------|
| TOTAL | 6.20E-03 | 2.06E-02 | 3.07E-02 | 2.50E-02 | 8.26E-02 |
| BODY INTERNAL ORGAN | 6.22E-03 | 2.09E-02 | 3.08E-02 | 2.51E-02 | 8.30E-02 |
| | GI_LLI | GI_LLI | GI_LLI | GI_LLI | GI_LLI |

THIS IS A REPORT FOR THE CALENDAR YEAR 2001

COMPLIANCE STATUS - 40 CFR 141

| TYPE | ANNUAL LIMIT | % OF LIMIT |
|------------------------------------|--------------|------------|
| TOTAL BODY INTERNAL ORGAN | 4.0 MREM | 2.064 |
| | 4.0 MREM | 2.076 |
| | | GI_LLI |

* THIS CALCULATION OF DOSE IS BASED ON TECHNIQUES DESCRIBED IN THE COMMONWEALTH EDISON OFFSITE DOSE CALCULATION MANUAL. THESE TECHNIQUES DIFFER FROM THOSE DESCRIBED IN 40 CFR 141.

RESULTS BASED UPON: ODCM ANNEX REVISION 2 DECEMBER 1996
 ODCM SOFTWARE VERSION 1.1 January 1995
 ODCM DATABASE VERSION 1.1 January 1995

BRAIDWOOD STATION UNIT TWO

ACTUAL 2001
 MAXIMUM DOSES (MREM) RESULTING FROM AQUATIC EFFLUENTS
 PERIOD OF RELEASE - 01/01/01 TO 12/31/01 CALCULATED 04/11/02
 ADULT RECEPTOR

| DOSE TYPE | 1ST QUARTER JAN-MAR | 2ND QUARTER APR-JUN | 3RD QUARTER JUL-SEP | 4TH QUARTER OCT-DEC | ANNUAL |
|-----------|---------------------------|---------------------------|---------------------------|---------------------------|----------|
| TOTAL | 4.54E-03 | 1.50E-02 | 2.25E-02 | 1.82E-02 | 6.02E-02 |
| BODY | | | | | |
| INTERNAL | 4.56E-03 | 1.55E-02 | 2.26E-02 | 1.84E-02 | 6.09E-02 |
| ORGAN | LIVER | GI_LLI | LIVER | GI_LLI | GI_LLI |

THIS IS A REPORT FOR THE CALENDAR YEAR 2001

COMPLIANCE STATUS - 10 CFR 50 APP. I

----- % OF APP I. -----

| | QTRLY OBJ | 1ST QTR JAN-MAR | 2ND QTR APR-JUN | 3RD QTR JUL-SEP | 4TH QTR OCT-DEC | YRLY OBJ | % OF APP. I |
|--------------------|--------------|--------------------|--------------------|--------------------|--------------------|-------------|----------------|
| TOTAL BODY (MREM) | 1.5 | 0.30 | 1.00 | 1.50 | 1.21 | 3.0 | 2.01 |
| CRIT. ORGAN (MREM) | 5.0 | 0.09 | 0.31 | 0.45 | 0.37 | 10.0 | 0.61 |
| | | LIVER | GI_LLI | LIVER | GI_LLI | | GI_LLI |

RESULTS BASED UPON: ODCM ANNEX REVISION 2 DECEMBER 1996
 ODCM SOFTWARE VERSION 1.1 January 1995
 ODCM DATABASE VERSION 1.1 January 1995

BRAIDWOOD STATION UNIT TWO

2001 ANNUAL REPORT

PROJECTED DOSE AT NEAREST COMMUNITY WATER SYSTEM *
 PERIOD OF RELEASE - 01/01/01 TO 12/31/01 CALCULATED 04/11/02
 ADULT RECEPTOR

| DOSE TYPE | 1ST QUARTER JAN-MAR | 2ND QUARTER APR-JUN | 3RD QUARTER JUL-SEP | 4TH QUARTER OCT-DEC | ANNUAL |
|---------------------------|---------------------------|---------------------------|---------------------------|---------------------------|----------|
| TOTAL | 4.45E-03 | 1.48E-02 | 2.20E-02 | 1.79E-02 | 5.92E-02 |
| BODY INTERNAL ORGAN | 4.47E-03 | 1.50E-02 | 2.21E-02 | 1.80E-02 | 5.96E-02 |
| | GI_LLI | GI_LLI | GI_LLI | GI_LLI | GI_LLI |

THIS IS A REPORT FOR THE CALENDAR YEAR 2001

COMPLIANCE STATUS - 40 CFR 141

| TYPE | ANNUAL LIMIT | % OF LIMIT |
|---------------------------|--------------|------------|
| TOTAL | 4.0 MREM | 1.480 |
| BODY INTERNAL ORGAN | 4.0 MREM | 1.490 |
| | | GI_LLI |

* THIS CALCULATION OF DOSE IS BASED ON TECHNIQUES DESCRIBED IN THE COMMONWEALTH EDISON OFFSITE DOSE CALCULATION MANUAL. THESE TECHNIQUES DIFFER FROM THOSE DESCRIBED IN 40 CFR 141.

RESULTS BASED UPON: ODCM ANNEX REVISION 2 DECEMBER 1996
 ODCM SOFTWARE VERSION 1.1 January 1995
 ODCM DATABASE VERSION 1.1 January 1995

BRAIDWOOD STATION UNIT ONE
 10 CFR 20 COMPLIANCE ASSESSMENT
 PERIOD OF ASSESSMENT 01/01/01 TO 12/31/01
 CALCULATED 04/11/02

1. 10 CFR 20.1301 (a)(1) Compliance

| | | |
|--|------------|-----------------|
| Total Effective Dose Equivalent, mrem/yr | | <u>7.27E-02</u> |
| 10 CFR 20.1301 (a)(1) limit | mrem/yr | <u>100.0</u> |
| | % of limit | <u>0.07</u> |

Compliance Summary - 10CFR20

| | 1st Qtr | 2nd Qtr | 3rd Qtr | 4th Qtr | % of Limit |
|------|------------|------------|------------|------------|---------------|
| TEDE | 7.59E-03 | 3.11E-02 | 2.02E-02 | 1.39E-02 | 0.07 |

RESULTS BASED UPON: ODCM ANNEX REVISION 2 DECEMBER 1996
 ODCM SOFTWARE VERSION 1.1 January 1995
 ODCM DATABASE VERSION 1.1 January 1995

BRAIDWOOD STATION UNIT ONE
 10 CFR 20 COMPLIANCE ASSESSMENT
 PERIOD OF ASSESSMENT 01/01/01 TO 12/31/01
 CALCULATED 04/11/02

2. 10 CFR 20.1301 (d)/40 CFR 190 Compliance

| | | Dose (mrem) | Limit (mrem) | % of Limit |
|---------------------|-----------|----------------|-----------------|---------------|
| Whole Body (DDE) | Plume | 3.17E-05 | | |
| | Skyshine | 0.00E+00 | | |
| | Ground | 8.35E-08 | | |
| | Total | 3.17E-05 | 25.0 | 0.00 |
| Organ Dose (CDE) | Thyroid | 7.24E-02 | 75.0 | 0.10 |
| | Gonads | 7.26E-02 | 25.0 | 0.29 |
| | Breast | 7.24E-02 | 25.0 | 0.29 |
| | Lung | 7.24E-02 | 25.0 | 0.29 |
| | Marrow | 7.26E-02 | 25.0 | 0.29 |
| | Bone | 7.38E-02 | 25.0 | 0.30 |
| | Remainder | 7.30E-02 | 25.0 | 0.29 |
| | CEDE | 7.27E-02 | | |
| | TEDE | 7.27E-02 | 100.0 | 0.07 |

RESULTS BASED UPON: ODCM ANNEX REVISION 2 DECEMBER 1996
 ODCM SOFTWARE VERSION 1.1 January 1995
 ODCM DATABASE VERSION 1.1 January 1995

BRAIDWOOD STATION UNIT TWO

10 CFR 20 COMPLIANCE ASSESSMENT

PERIOD OF ASSESSMENT 01/01/01 TO 12/31/01

CALCULATED 04/11/02

1. 10 CFR 20.1301 (a)(1) Compliance

Total Effective Dose Equivalent, mrem/yr 6.35E-02

10 CFR 20.1301 (a)(1) limit mrem/yr 100.0

% of limit 0.06

Compliance Summary - 10CFR20

| | 1st Qtr | 2nd Qtr | 3rd Qtr | 4th Qtr | % of Limit |
|------|------------|------------|------------|------------|---------------|
| TEDE | 3.35E-03 | 2.92E-02 | 1.97E-02 | 1.12E-02 | 0.06 |

RESULTS BASED UPON: ODCM ANNEX REVISION 2 DECEMBER 1996
ODCM SOFTWARE VERSION 1.1 January 1995
ODCM DATABASE VERSION 1.1 January 1995

BRAIDWOOD STATION UNIT TWO
 10 CFR 20 COMPLIANCE ASSESSMENT
 PERIOD OF ASSESSMENT 01/01/01 TO 12/31/01
 CALCULATED 04/11/02

2. 10 CFR 20.1301 (d)/40 CFR 190 Compliance

| | | Dose (mrem) | Limit (mrem) | % of Limit |
|---------------------|-----------|----------------|-----------------|---------------|
| Whole Body (DDE) | Plume | 3.06E-05 | | |
| | Skyshine | 0.00E+00 | | |
| | Ground | 9.84E-06 | | |
| | Total | 4.04E-05 | 25.0 | 0.00 |
| Organ Dose (CDE) | Thyroid | 6.31E-02 | 75.0 | 0.08 |
| | Gonads | 6.33E-02 | 25.0 | 0.25 |
| | Breast | 6.32E-02 | 25.0 | 0.25 |
| | Lung | 6.31E-02 | 25.0 | 0.25 |
| | Marrow | 6.33E-02 | 25.0 | 0.25 |
| | Bone | 6.45E-02 | 25.0 | 0.26 |
| | Remainder | 6.37E-02 | 25.0 | 0.25 |
| | CEDE | 6.34E-02 | | |
| | TEDE | 6.35E-02 | 100.0 | 0.06 |

RESULTS BASED UPON: ODCM ANNEX REVISION 2 DECEMBER 1996
 ODCM SOFTWARE VERSION 1.1 January 1995
 ODCM DATABASE VERSION 1.1 January 1995

Braidwood Nuclear Station
 34 ft. Wind Speed and Direction

April-June, 2001
 203Ft-34Ft Delta-T (F)

Number of Observations = 2154
 Values are Percent Occurrence

| SPEED CLASS | WIND DIRECTION CLASSES | | | | | | | | | | | | | | | | STABILITY CLASSES | | | | | | | TOTAL | | |
|-------------|------------------------|------|------|------|------|------|------|------|------|------|------|------|------|------|------|------|-------------------|------|------|------|-------|-------|------|-------|----|-------|
| | N | NNE | NE | ENE | E | ESE | SE | SSE | S | SSW | SW | WSW | W | WNW | NW | NNW | TOTAL | EU | MU | SU | N | SS | MS | | ES | TOTAL |
| EU | 0.00 | 0.00 | 0.00 | 0.00 | 0.00 | 0.00 | 0.00 | 0.00 | 0.00 | 0.00 | 0.00 | 0.00 | 0.00 | 0.00 | 0.00 | 0.00 | 0.00 | 0.00 | 0.00 | | | | | | | |
| MU | 0.00 | 0.00 | 0.00 | 0.00 | 0.00 | 0.00 | 0.00 | 0.00 | 0.00 | 0.00 | 0.00 | 0.00 | 0.00 | 0.00 | 0.00 | 0.00 | 0.00 | | 0.00 | | | | | | | |
| C SU | 0.00 | 0.00 | 0.00 | 0.00 | 0.00 | 0.00 | 0.00 | 0.00 | 0.00 | 0.00 | 0.00 | 0.00 | 0.00 | 0.00 | 0.00 | 0.00 | 0.00 | | | 0.00 | | | | | | |
| A N | 0.00 | 0.00 | 0.00 | 0.00 | 0.00 | 0.00 | 0.00 | 0.00 | 0.00 | 0.00 | 0.00 | 0.00 | 0.00 | 0.00 | 0.00 | 0.00 | 0.00 | | | | 0.00 | | | | | |
| L SS | 0.00 | 0.00 | 0.00 | 0.00 | 0.00 | 0.00 | 0.00 | 0.00 | 0.00 | 0.00 | 0.00 | 0.00 | 0.00 | 0.00 | 0.00 | 0.00 | 0.00 | | | | | 0.00 | | | | |
| M MS | 0.00 | 0.00 | 0.05 | 0.00 | 0.00 | 0.00 | 0.00 | 0.00 | 0.00 | 0.00 | 0.00 | 0.00 | 0.00 | 0.00 | 0.00 | 0.00 | 0.05 | | | | | | 0.05 | | | |
| ES | 0.00 | 0.05 | 0.09 | 0.00 | 0.00 | 0.00 | 0.00 | 0.00 | 0.00 | 0.00 | 0.00 | 0.00 | 0.00 | 0.00 | 0.00 | 0.00 | 0.14 | | | | | | | 0.14 | | |
| | 0.19 | | | | | | | | | | | | | | | | | | | | | | | | | |
| EU | 0.00 | 0.00 | 0.00 | 0.00 | 0.00 | 0.00 | 0.00 | 0.00 | 0.00 | 0.05 | 0.00 | 0.00 | 0.00 | 0.00 | 0.00 | 0.00 | 0.05 | 0.05 | | | | | | | | |
| MU | 0.00 | 0.00 | 0.00 | 0.00 | 0.00 | 0.00 | 0.00 | 0.00 | 0.00 | 0.00 | 0.00 | 0.00 | 0.00 | 0.00 | 0.00 | 0.00 | 0.00 | | 0.00 | | | | | | | |
| 1 SU | 0.00 | 0.00 | 0.00 | 0.00 | 0.09 | 0.00 | 0.00 | 0.00 | 0.00 | 0.00 | 0.00 | 0.05 | 0.00 | 0.00 | 0.00 | 0.00 | 0.14 | | | 0.14 | | | | | | |
| N | 0.09 | 0.19 | 0.14 | 0.05 | 0.23 | 0.00 | 0.14 | 0.09 | 0.00 | 0.00 | 0.19 | 0.00 | 0.09 | 0.00 | 0.28 | 0.14 | 1.62 | | | | 1.62 | | | | | |
| 3 SS | 0.09 | 0.37 | 0.42 | 0.70 | 0.84 | 0.19 | 0.56 | 0.51 | 0.00 | 0.09 | 0.05 | 0.19 | 0.32 | 0.42 | 0.23 | 0.28 | 5.25 | | | | | 5.25 | | | | |
| MS | 0.14 | 0.14 | 0.28 | 0.65 | 0.56 | 0.42 | 0.60 | 0.46 | 0.19 | 0.05 | 0.23 | 0.51 | 0.28 | 0.51 | 0.23 | 0.19 | 5.43 | | | | | | 5.43 | | | |
| ES | 0.28 | 0.19 | 0.23 | 0.19 | 0.32 | 0.09 | 0.23 | 0.09 | 0.00 | 0.05 | 0.00 | 0.14 | 0.28 | 0.60 | 0.19 | 0.19 | 3.06 | | | | | | | 3.06 | | |
| | 15.55 | | | | | | | | | | | | | | | | | | | | | | | | | |
| EU | 0.00 | 0.09 | 0.00 | 0.00 | 0.00 | 0.00 | 0.28 | 0.70 | 0.79 | 0.19 | 0.05 | 0.05 | 0.00 | 0.00 | 0.00 | 0.00 | 2.14 | 2.14 | | | | | | | | |
| MU | 0.05 | 0.09 | 0.00 | 0.05 | 0.00 | 0.05 | 0.05 | 0.09 | 0.14 | 0.05 | 0.09 | 0.00 | 0.05 | 0.05 | 0.00 | 0.09 | 0.84 | | 0.84 | | | | | | | |
| 4 SU | 0.09 | 0.19 | 0.05 | 0.05 | 0.14 | 0.19 | 0.09 | 0.14 | 0.19 | 0.00 | 0.05 | 0.23 | 0.05 | 0.05 | 0.00 | 0.19 | 1.67 | | | 1.67 | | | | | | |
| N | 0.51 | 1.02 | 1.30 | 0.97 | 0.28 | 0.42 | 0.60 | 0.56 | 0.51 | 0.19 | 0.46 | 0.51 | 0.65 | 0.74 | 0.56 | 0.84 | 10.12 | | | | 10.12 | | | | | |
| 7 SS | 0.65 | 1.67 | 2.65 | 2.51 | 1.58 | 1.72 | 1.81 | 1.81 | 0.97 | 0.60 | 0.88 | 1.67 | 1.44 | 1.35 | 0.23 | 0.28 | 21.82 | | | | | 21.82 | | | | |
| MS | 0.00 | 0.00 | 0.00 | 0.09 | 0.19 | 0.32 | 0.42 | 0.28 | 0.28 | 0.28 | 0.23 | 0.93 | 0.19 | 0.09 | 0.00 | 0.00 | 3.30 | | | | | | 3.30 | | | |
| ES | 0.00 | 0.00 | 0.00 | 0.00 | 0.05 | 0.05 | 0.00 | 0.00 | 0.00 | 0.00 | 0.00 | 0.42 | 0.23 | 0.00 | 0.00 | 0.00 | 0.74 | | | | | | | 0.74 | | |
| | 40.62 | | | | | | | | | | | | | | | | | | | | | | | | | |
| EU | 0.00 | 0.05 | 0.00 | 0.00 | 0.05 | 0.00 | 0.05 | 0.05 | 0.37 | 0.23 | 0.23 | 0.09 | 0.51 | 0.37 | 0.09 | 0.00 | 2.09 | 2.09 | | | | | | | | |
| MU | 0.05 | 0.05 | 0.09 | 0.00 | 0.19 | 0.05 | 0.09 | 0.14 | 0.14 | 0.14 | 0.05 | 0.05 | 0.14 | 0.32 | 0.00 | 0.14 | 1.62 | | 1.62 | | | | | | | |
| 8 SU | 0.05 | 0.05 | 0.23 | 0.09 | 0.09 | 0.00 | 0.09 | 0.05 | 0.19 | 0.19 | 0.14 | 0.14 | 0.19 | 0.19 | 0.00 | 0.09 | 1.76 | | | 1.76 | | | | | | |
| N | 0.09 | 0.51 | 1.07 | 0.09 | 0.28 | 0.23 | 0.51 | 0.74 | 0.70 | 0.56 | 0.93 | 0.65 | 0.84 | 0.46 | 0.42 | 0.23 | 8.31 | | | | 8.31 | | | | | |
| 1 SS | 0.28 | 1.07 | 0.93 | 0.05 | 0.32 | 0.42 | 1.49 | 1.76 | 3.39 | 2.32 | 1.25 | 1.11 | 0.51 | 0.65 | 0.37 | 0.09 | 16.02 | | | | | 16.02 | | | | |
| 2 MS | 0.00 | 0.05 | 0.00 | 0.00 | 0.00 | 0.00 | 0.05 | 0.19 | 0.05 | 0.14 | 0.00 | 0.00 | 0.00 | 0.00 | 0.00 | 0.00 | 0.46 | | | | | | 0.46 | | | |
| ES | 0.00 | 0.00 | 0.00 | 0.00 | 0.00 | 0.00 | 0.00 | 0.00 | 0.00 | 0.00 | 0.00 | 0.00 | 0.00 | 0.00 | 0.00 | 0.00 | 0.00 | | | | | | | 0.00 | | |
| | 30.27 | | | | | | | | | | | | | | | | | | | | | | | | | |
| EU | 0.00 | 0.00 | 0.00 | 0.00 | 0.00 | 0.00 | 0.00 | 0.00 | 0.05 | 0.28 | 0.14 | 0.14 | 0.00 | 0.00 | 0.00 | 0.00 | 0.60 | 0.60 | | | | | | | | |
| 1 MU | 0.05 | 0.00 | 0.00 | 0.00 | 0.00 | 0.00 | 0.00 | 0.00 | 0.14 | 0.23 | 0.19 | 0.19 | 0.00 | 0.09 | 0.00 | 0.19 | 1.07 | | 1.07 | | | | | | | |
| 3 SU | 0.05 | 0.00 | 0.05 | 0.00 | 0.00 | 0.00 | 0.00 | 0.00 | 0.00 | 0.28 | 0.32 | 0.05 | 0.00 | 0.14 | 0.00 | 0.00 | 0.88 | | | 0.88 | | | | | | |
| N | 0.09 | 0.00 | 0.19 | 0.00 | 0.00 | 0.00 | 0.00 | 0.00 | 0.23 | 1.11 | 1.39 | 0.46 | 0.19 | 0.42 | 0.00 | 0.09 | 4.18 | | | | 4.18 | | | | | |
| 1 SS | 0.00 | 0.05 | 0.00 | 0.00 | 0.00 | 0.00 | 0.05 | 0.32 | 1.58 | 1.25 | 0.60 | 0.05 | 0.46 | 0.05 | 0.14 | 0.09 | 4.64 | | | | | 4.64 | | | | |
| 8 MS | 0.00 | 0.00 | 0.00 | 0.00 | 0.00 | 0.00 | 0.00 | 0.00 | 0.00 | 0.00 | 0.00 | 0.00 | 0.00 | 0.00 | 0.00 | 0.00 | 0.00 | | | | | | 0.00 | | | |
| ES | 0.00 | 0.00 | 0.00 | 0.00 | 0.00 | 0.00 | 0.00 | 0.00 | 0.00 | 0.00 | 0.00 | 0.00 | 0.00 | 0.00 | 0.00 | 0.00 | 0.00 | | | | | | | 0.00 | | |
| | 11.37 | | | | | | | | | | | | | | | | | | | | | | | | | |

Braidwood Nuclear Station
34 ft. Wind Speed and Direction

April-June, 2001
203Ft-34Ft Delta-T (F)

| SPEED CLASS | WIND DIRECTION CLASSES | | | | | | | | | | | | | | | | STABILITY CLASSES | | | | | | | | | |
|-------------|------------------------|------|------|------|------|------|------|------|-------|------|------|------|------|------|------|------|-------------------|------|------|------|-------|-------|------|------|--------|------|
| | N | NNE | NE | ENE | E | ESE | SE | SSE | S | SSW | SW | WSW | W | WNW | NW | NNW | TOTAL | EU | MU | SU | N | SS | MS | ES | TOTAL | |
| EU | 0.00 | 0.00 | 0.00 | 0.00 | 0.00 | 0.00 | 0.00 | 0.00 | 0.00 | 0.00 | 0.00 | 0.00 | 0.00 | 0.00 | 0.00 | 0.00 | 0.00 | 0.00 | | | | | | | | 1.72 |
| 1 MU | 0.00 | 0.00 | 0.00 | 0.00 | 0.00 | 0.00 | 0.00 | 0.00 | 0.00 | 0.00 | 0.00 | 0.00 | 0.00 | 0.00 | 0.00 | 0.00 | 0.00 | 0.00 | 0.00 | | | | | | | 0.00 |
| 9 SU | 0.00 | 0.00 | 0.00 | 0.00 | 0.00 | 0.00 | 0.00 | 0.00 | 0.00 | 0.00 | 0.00 | 0.05 | 0.00 | 0.00 | 0.00 | 0.00 | 0.05 | | | 0.05 | | | | | | |
| > N | 0.00 | 0.00 | 0.00 | 0.00 | 0.00 | 0.00 | 0.00 | 0.00 | 0.05 | 0.05 | 0.05 | 0.23 | 0.09 | 0.00 | 0.00 | 0.00 | 0.46 | | | | 0.46 | | | | | |
| 2 SS | 0.00 | 0.00 | 0.00 | 0.00 | 0.00 | 0.00 | 0.00 | 0.00 | 0.32 | 0.28 | 0.23 | 0.23 | 0.14 | 0.00 | 0.00 | 0.00 | 1.21 | | | | | 1.21 | | | | |
| 4 MS | 0.00 | 0.00 | 0.00 | 0.00 | 0.00 | 0.00 | 0.00 | 0.00 | 0.00 | 0.00 | 0.00 | 0.00 | 0.00 | 0.00 | 0.00 | 0.00 | 0.00 | | | | | | 0.00 | | | |
| ES | 0.00 | 0.00 | 0.00 | 0.00 | 0.00 | 0.00 | 0.00 | 0.00 | 0.00 | 0.00 | 0.00 | 0.00 | 0.00 | 0.00 | 0.00 | 0.00 | 0.00 | | | | | | | 0.00 | | |
| TOT | 2.55 | 5.80 | 7.75 | 5.48 | 5.20 | 4.13 | 7.10 | 7.99 | 10.26 | 8.77 | 7.85 | 8.12 | 6.64 | 6.50 | 2.74 | 3.11 | 100.00 | 4.87 | 3.53 | 4.50 | 24.84 | 49.07 | 9.24 | 3.95 | 100.00 | |

Wind Direction by Stability

| N | NNE | NE | ENE | E | ESE | SE | SSE | S | SSW | SW | WSW | W | WNW | NW | NNW | TOTAL | -STABILITY CLASSES- |
|------|------|------|------|------|------|------|------|------|------|------|------|------|------|------|------|-------|---------------------|
| 0.00 | 0.14 | 0.00 | 0.00 | 0.05 | 0.00 | 0.32 | 0.74 | 1.21 | 0.74 | 0.42 | 0.28 | 0.51 | 0.37 | 0.09 | 0.00 | 4.87 | Extremely Unstable |
| 0.14 | 0.14 | 0.09 | 0.05 | 0.19 | 0.09 | 0.14 | 0.23 | 0.42 | 0.42 | 0.32 | 0.23 | 0.19 | 0.46 | 0.00 | 0.42 | 3.53 | Moderately Unstable |
| 0.19 | 0.23 | 0.32 | 0.14 | 0.32 | 0.19 | 0.19 | 0.19 | 0.37 | 0.46 | 0.51 | 0.51 | 0.23 | 0.37 | 0.00 | 0.28 | 4.50 | Slightly Unstable |
| 0.79 | 1.72 | 2.69 | 1.11 | 0.79 | 0.65 | 1.25 | 1.39 | 1.49 | 1.95 | 3.11 | 1.86 | 1.86 | 1.62 | 1.25 | 1.30 | 24.84 | Neutral |
| 1.02 | 3.16 | 3.99 | 3.25 | 2.74 | 2.32 | 3.90 | 4.41 | 6.27 | 4.69 | 3.02 | 3.25 | 2.88 | 2.46 | 0.97 | 0.74 | 49.07 | Slightly Stable |
| 0.14 | 0.19 | 0.32 | 0.74 | 0.74 | 0.74 | 1.07 | 0.93 | 0.51 | 0.46 | 0.46 | 1.44 | 0.46 | 0.60 | 0.23 | 0.19 | 9.24 | Moderately Stable |
| 0.28 | 0.23 | 0.32 | 0.19 | 0.37 | 0.14 | 0.23 | 0.09 | 0.00 | 0.05 | 0.00 | 0.56 | 0.51 | 0.60 | 0.19 | 0.19 | 3.95 | Extremely Stable |

Wind Direction by Wind Speed

| N | NNE | NE | ENE | E | ESE | SE | SSE | S | SSW | SW | WSW | W | WNW | NW | NNW | TOTAL | -WIND SPEED CLASSES- |
|------|------|------|------|------|------|------|------|------|------|------|------|------|------|------|------|-------|----------------------|
| 0.00 | 0.05 | 0.14 | 0.00 | 0.00 | 0.00 | 0.00 | 0.00 | 0.00 | 0.00 | 0.00 | 0.00 | 0.00 | 0.00 | 0.00 | 0.00 | 0.19 | C A L M |
| 0.60 | 0.88 | 1.07 | 1.58 | 2.04 | 0.70 | 1.53 | 1.16 | 0.19 | 0.23 | 0.46 | 0.88 | 0.97 | 1.53 | 0.93 | 0.79 | 15.55 | 1.0- 3.5 mph |
| 1.30 | 3.06 | 3.99 | 3.67 | 2.23 | 2.74 | 3.25 | 3.57 | 2.88 | 1.30 | 1.76 | 3.81 | 2.60 | 2.27 | 0.79 | 1.39 | 40.62 | 3.6- 7.5 mph |
| 0.46 | 1.76 | 2.32 | 0.23 | 0.93 | 0.70 | 2.27 | 2.92 | 4.83 | 3.57 | 2.60 | 2.04 | 2.18 | 2.00 | 0.88 | 0.56 | 30.27 | 7.6-12.5 mph |
| 0.19 | 0.05 | 0.23 | 0.00 | 0.00 | 0.00 | 0.05 | 0.32 | 2.00 | 3.16 | 2.65 | 0.88 | 0.65 | 0.70 | 0.14 | 0.37 | 11.37 | 12.6-18.5 mph |
| 0.00 | 0.00 | 0.00 | 0.00 | 0.00 | 0.00 | 0.00 | 0.00 | 0.37 | 0.32 | 0.28 | 0.51 | 0.23 | 0.00 | 0.00 | 0.00 | 1.72 | 18.6-24.5 mph |
| 0.00 | 0.00 | 0.00 | 0.00 | 0.00 | 0.00 | 0.00 | 0.00 | 0.00 | 0.19 | 0.09 | 0.00 | 0.00 | 0.00 | 0.00 | 0.00 | 0.28 | >24.5 mph |

Braidwood Nuclear Station
34 ft. Wind Speed and Direction

July-September, 2001
203Ft-34Ft Delta-T (F)

Number of Observations = 2171
Values are Percent Occurrence

| SPEED | WIND DIRECTION CLASSES | | | | | | | | | | | | | | | | STABILITY CLASSES | | | | | | | | |
|-------|------------------------|------|------|------|------|------|------|------|------|------|------|------|------|------|------|------|-------------------|------|------|-------|-------|-------|------|-------|-------|
| CLASS | N | NNE | NE | ENE | E | ESE | SE | SSE | S | SSW | SW | WSW | W | WNW | NW | NNW | TOTAL | EU | MU | SU | N | SS | MS | ES | TOTAL |
| EU | 0.00 | 0.00 | 0.00 | 0.00 | 0.00 | 0.00 | 0.00 | 0.00 | 0.00 | 0.00 | 0.00 | 0.00 | 0.00 | 0.00 | 0.00 | 0.00 | 0.00 | 0.00 | | | | | | | |
| MU | 0.00 | 0.00 | 0.00 | 0.00 | 0.00 | 0.00 | 0.00 | 0.00 | 0.00 | 0.00 | 0.00 | 0.00 | 0.00 | 0.00 | 0.00 | 0.00 | 0.00 | 0.00 | | | | | | | |
| C SU | 0.00 | 0.00 | 0.00 | 0.00 | 0.00 | 0.00 | 0.00 | 0.00 | 0.00 | 0.00 | 0.00 | 0.00 | 0.00 | 0.00 | 0.00 | 0.00 | 0.00 | | 0.00 | | | | | | |
| A N | 0.00 | 0.00 | 0.00 | 0.00 | 0.00 | 0.00 | 0.00 | 0.00 | 0.00 | 0.00 | 0.00 | 0.00 | 0.00 | 0.00 | 0.00 | 0.00 | 0.00 | | | 0.00 | | | | | |
| L SS | 0.00 | 0.00 | 0.00 | 0.00 | 0.00 | 0.00 | 0.00 | 0.00 | 0.00 | 0.00 | 0.00 | 0.00 | 0.00 | 0.00 | 0.00 | 0.00 | 0.00 | | | | 0.00 | | | | |
| M MS | 0.00 | 0.00 | 0.05 | 0.00 | 0.00 | 0.00 | 0.00 | 0.00 | 0.05 | 0.00 | 0.00 | 0.00 | 0.00 | 0.05 | 0.00 | 0.00 | 0.14 | | | | | 0.14 | | | |
| ES | 0.00 | 0.00 | 0.00 | 0.05 | 0.00 | 0.00 | 0.00 | 0.00 | 0.00 | 0.00 | 0.00 | 0.00 | 0.00 | 0.00 | 0.05 | 0.00 | 0.09 | | | | | | | 0.09 | 0.23 |
| EU | 0.00 | 0.00 | 0.05 | 0.00 | 0.00 | 0.00 | 0.05 | 0.00 | 0.05 | 0.00 | 0.09 | 0.00 | 0.05 | 0.05 | 0.00 | 0.00 | 0.32 | 0.32 | | | | | | | |
| MU | 0.00 | 0.00 | 0.00 | 0.05 | 0.05 | 0.00 | 0.00 | 0.05 | 0.00 | 0.05 | 0.09 | 0.05 | 0.00 | 0.00 | 0.05 | 0.05 | 0.41 | 0.41 | | | | | | | |
| 1 SU | 0.05 | 0.05 | 0.05 | 0.05 | 0.00 | 0.09 | 0.05 | 0.05 | 0.00 | 0.05 | 0.09 | 0.00 | 0.18 | 0.05 | 0.05 | 0.05 | 0.83 | | 0.83 | | | | | | |
| - N | 0.18 | 0.14 | 0.69 | 0.28 | 0.37 | 0.23 | 0.18 | 0.18 | 0.05 | 0.09 | 0.28 | 0.09 | 0.23 | 0.18 | 0.14 | 0.09 | 3.41 | | | 3.41 | | | | | |
| 3 SS | 0.05 | 0.37 | 1.11 | 1.93 | 2.21 | 0.32 | 0.41 | 0.23 | 0.05 | 0.18 | 0.23 | 0.23 | 0.88 | 0.55 | 0.55 | 0.18 | 9.49 | | | | 9.49 | | | | |
| MS | 0.51 | 0.51 | 0.64 | 0.64 | 1.24 | 1.15 | 0.55 | 0.14 | 0.23 | 0.14 | 0.32 | 0.51 | 0.97 | 1.01 | 0.74 | 0.83 | 10.13 | | | | | 10.13 | | | |
| ES | 0.60 | 0.09 | 0.14 | 0.55 | 0.55 | 0.09 | 0.09 | 0.05 | 0.09 | 0.18 | 0.23 | 0.74 | 1.38 | 0.51 | 0.51 | 0.41 | 6.22 | | | | | | 6.22 | 30.82 | |
| EU | 0.09 | 0.46 | 0.69 | 0.60 | 0.60 | 0.37 | 0.28 | 0.37 | 0.78 | 0.60 | 0.64 | 0.41 | 1.66 | 0.51 | 0.37 | 0.28 | 8.71 | 8.71 | | | | | | | |
| MU | 0.09 | 0.18 | 0.32 | 0.37 | 0.14 | 0.09 | 0.32 | 0.32 | 0.14 | 0.23 | 0.18 | 0.28 | 0.46 | 0.14 | 0.14 | 0.14 | 3.55 | 3.55 | | | | | | | |
| 4 SU | 0.05 | 0.28 | 0.51 | 0.18 | 0.14 | 0.32 | 0.09 | 0.37 | 0.09 | 0.09 | 0.23 | 0.28 | 0.09 | 0.18 | 0.23 | 0.05 | 3.18 | | 3.18 | | | | | | |
| - N | 0.55 | 1.52 | 1.29 | 0.97 | 0.69 | 0.64 | 0.88 | 1.06 | 0.41 | 0.37 | 0.51 | 0.55 | 0.78 | 0.51 | 0.51 | 0.18 | 11.42 | | | 11.42 | | | | | |
| 7 SS | 0.64 | 1.47 | 0.88 | 0.69 | 0.28 | 0.78 | 1.80 | 2.49 | 2.03 | 1.15 | 1.43 | 2.07 | 1.61 | 0.28 | 0.14 | 0.78 | 18.52 | | | | 18.52 | | | | |
| MS | 0.09 | 0.14 | 0.00 | 0.00 | 0.00 | 0.23 | 0.46 | 0.23 | 0.14 | 0.00 | 0.05 | 0.83 | 0.09 | 0.09 | 0.05 | 0.00 | 2.40 | | | | | 2.40 | | | |
| ES | 0.00 | 0.05 | 0.00 | 0.00 | 0.09 | 0.00 | 0.00 | 0.00 | 0.00 | 0.05 | 0.00 | 0.28 | 0.05 | 0.05 | 0.00 | 0.00 | 0.55 | | | | | | 0.55 | 48.32 | |
| EU | 0.18 | 0.46 | 0.55 | 0.00 | 0.00 | 0.00 | 0.00 | 0.23 | 0.32 | 0.46 | 0.37 | 0.97 | 0.69 | 0.46 | 0.05 | 0.41 | 5.16 | 5.16 | | | | | | | |
| MU | 0.05 | 0.14 | 0.14 | 0.05 | 0.00 | 0.00 | 0.00 | 0.14 | 0.00 | 0.23 | 0.18 | 0.09 | 0.14 | 0.23 | 0.00 | 0.14 | 1.52 | 1.52 | | | | | | | |
| 8 SU | 0.18 | 0.32 | 0.14 | 0.00 | 0.00 | 0.00 | 0.00 | 0.00 | 0.00 | 0.05 | 0.32 | 0.18 | 0.00 | 0.09 | 0.00 | 0.32 | 1.61 | | 1.61 | | | | | | |
| - N | 0.46 | 0.74 | 0.64 | 0.05 | 0.00 | 0.05 | 0.09 | 0.88 | 0.51 | 0.83 | 0.55 | 0.18 | 0.64 | 0.41 | 0.00 | 0.83 | 6.86 | | | 6.86 | | | | | |
| 1 SS | 0.09 | 0.14 | 0.00 | 0.00 | 0.00 | 0.05 | 0.37 | 0.78 | 1.11 | 0.28 | 0.23 | 0.00 | 0.00 | 0.09 | 0.05 | 0.18 | 3.36 | | | | 3.36 | | | | |
| 2 MS | 0.00 | 0.00 | 0.00 | 0.00 | 0.00 | 0.00 | 0.00 | 0.00 | 0.00 | 0.00 | 0.00 | 0.00 | 0.00 | 0.05 | 0.00 | 0.00 | 0.05 | | | | | 0.05 | | | |
| ES | 0.00 | 0.00 | 0.00 | 0.00 | 0.00 | 0.00 | 0.00 | 0.00 | 0.00 | 0.00 | 0.00 | 0.00 | 0.00 | 0.00 | 0.00 | 0.00 | 0.00 | | | | | | 0.00 | 18.56 | |
| EU | 0.14 | 0.00 | 0.00 | 0.00 | 0.00 | 0.00 | 0.00 | 0.00 | 0.09 | 0.09 | 0.00 | 0.18 | 0.00 | 0.00 | 0.00 | 0.00 | 0.51 | 0.51 | | | | | | | |
| 1 MU | 0.09 | 0.00 | 0.00 | 0.00 | 0.00 | 0.00 | 0.00 | 0.00 | 0.00 | 0.14 | 0.05 | 0.05 | 0.00 | 0.00 | 0.00 | 0.00 | 0.32 | 0.32 | | | | | | | |
| 3 SU | 0.00 | 0.00 | 0.00 | 0.00 | 0.00 | 0.00 | 0.00 | 0.00 | 0.00 | 0.09 | 0.00 | 0.00 | 0.00 | 0.00 | 0.00 | 0.05 | 0.14 | | 0.14 | | | | | | |
| - N | 0.32 | 0.05 | 0.00 | 0.00 | 0.00 | 0.00 | 0.00 | 0.14 | 0.05 | 0.23 | 0.05 | 0.05 | 0.05 | 0.00 | 0.00 | 0.00 | 0.92 | | | 0.92 | | | | | |
| 1 SS | 0.00 | 0.00 | 0.00 | 0.00 | 0.00 | 0.00 | 0.05 | 0.00 | 0.09 | 0.05 | 0.00 | 0.00 | 0.00 | 0.00 | 0.00 | 0.00 | 0.18 | | | | 0.18 | | | | |
| 8 MS | 0.00 | 0.00 | 0.00 | 0.00 | 0.00 | 0.00 | 0.00 | 0.00 | 0.00 | 0.00 | 0.00 | 0.00 | 0.00 | 0.00 | 0.00 | 0.00 | 0.00 | | | | | 0.00 | | | |
| ES | 0.00 | 0.00 | 0.00 | 0.00 | 0.00 | 0.00 | 0.00 | 0.00 | 0.00 | 0.00 | 0.00 | 0.00 | 0.00 | 0.00 | 0.00 | 0.00 | 0.00 | | | | | | 0.00 | 2.07 | |

Braidwood Nuclear Station
34 ft. Wind Speed and Direction

January-December, 2001
203Ft-34Ft Delta-T (F)

| SPEED CLASS | WIND DIRECTION CLASSES | | | | | | | | | | | | | | | | STABILITY CLASSES | | | | | | | TOTAL | | | |
|-------------|------------------------|------|------|------|------|------|------|------|------|------|------|------|------|------|------|------|-------------------|------|------|------|-------|-------|------|-------|--|--------|------|
| | N | NNE | NE | ENE | E | ESE | SE | SSE | S | SSW | SW | WSW | W | WNW | NW | NNW | EU | MU | SU | N | SS | MS | ES | | | | |
| EU | 0.00 | 0.00 | 0.00 | 0.00 | 0.00 | 0.00 | 0.00 | 0.01 | 0.00 | 0.00 | 0.00 | 0.00 | 0.00 | 0.00 | 0.00 | 0.01 | 0.01 | | | | | | | | | | |
| 1 MU | 0.00 | 0.00 | 0.00 | 0.00 | 0.00 | 0.00 | 0.00 | 0.01 | 0.01 | 0.00 | 0.00 | 0.00 | 0.00 | 0.00 | 0.00 | 0.00 | 0.02 | 0.02 | | | | | | | | | |
| 9 SU | 0.00 | 0.00 | 0.00 | 0.00 | 0.00 | 0.00 | 0.00 | 0.01 | 0.00 | 0.00 | 0.01 | 0.00 | 0.00 | 0.00 | 0.00 | 0.00 | 0.02 | 0.02 | 0.02 | | | | | | | | |
| - N | 0.00 | 0.00 | 0.00 | 0.00 | 0.00 | 0.00 | 0.00 | 0.01 | 0.07 | 0.20 | 0.09 | 0.07 | 0.08 | 0.00 | 0.00 | 0.00 | 0.52 | 0.52 | | | | | | | | | |
| 2 SS | 0.00 | 0.00 | 0.00 | 0.00 | 0.00 | 0.00 | 0.00 | 0.02 | 0.13 | 0.09 | 0.07 | 0.07 | 0.03 | 0.00 | 0.00 | 0.00 | 0.42 | 0.42 | | | | | | | | | |
| 4 MS | 0.00 | 0.00 | 0.00 | 0.00 | 0.00 | 0.00 | 0.00 | 0.00 | 0.00 | 0.00 | 0.00 | 0.00 | 0.00 | 0.00 | 0.00 | 0.00 | 0.00 | 0.00 | | | | 0.00 | | | | | |
| ES | 0.00 | 0.00 | 0.00 | 0.00 | 0.00 | 0.00 | 0.00 | 0.00 | 0.00 | 0.00 | 0.00 | 0.00 | 0.00 | 0.00 | 0.00 | 0.00 | 0.00 | 0.00 | | | | | 0.00 | | | | |
| | | | | | | | | | | | | | | | | | | | | | | | | | | | 1.00 |
| EU | 0.00 | 0.00 | 0.00 | 0.00 | 0.00 | 0.00 | 0.00 | 0.00 | 0.00 | 0.00 | 0.00 | 0.00 | 0.00 | 0.00 | 0.00 | 0.00 | 0.00 | 0.00 | 0.00 | | | | | | | | |
| MU | 0.00 | 0.00 | 0.00 | 0.00 | 0.00 | 0.00 | 0.00 | 0.00 | 0.00 | 0.00 | 0.00 | 0.00 | 0.00 | 0.00 | 0.00 | 0.00 | 0.00 | 0.00 | 0.00 | 0.00 | | | | | | | |
| SU | 0.00 | 0.00 | 0.00 | 0.00 | 0.00 | 0.00 | 0.00 | 0.00 | 0.00 | 0.00 | 0.00 | 0.00 | 0.00 | 0.00 | 0.00 | 0.00 | 0.00 | 0.00 | 0.00 | 0.00 | | | | | | | |
| > N | 0.00 | 0.00 | 0.00 | 0.00 | 0.00 | 0.00 | 0.00 | 0.00 | 0.01 | 0.02 | 0.02 | 0.01 | 0.00 | 0.00 | 0.00 | 0.07 | 0.07 | 0.07 | | | | | | | | | |
| 2 SS | 0.00 | 0.00 | 0.00 | 0.00 | 0.00 | 0.00 | 0.00 | 0.00 | 0.00 | 0.03 | 0.00 | 0.03 | 0.00 | 0.00 | 0.00 | 0.00 | 0.07 | 0.07 | | | | | | | | | |
| 4 MS | 0.00 | 0.00 | 0.00 | 0.00 | 0.00 | 0.00 | 0.00 | 0.00 | 0.00 | 0.00 | 0.00 | 0.00 | 0.00 | 0.00 | 0.00 | 0.00 | 0.00 | 0.00 | | | | 0.00 | | | | | |
| ES | 0.00 | 0.00 | 0.00 | 0.00 | 0.00 | 0.00 | 0.00 | 0.00 | 0.00 | 0.00 | 0.00 | 0.00 | 0.00 | 0.00 | 0.00 | 0.00 | 0.00 | 0.00 | | | | | 0.00 | | | | |
| | | | | | | | | | | | | | | | | | | | | | | | | | | | 0.14 |
| TOT | 3.30 | 4.74 | 5.61 | 4.66 | 4.05 | 3.77 | 5.12 | 6.70 | 8.01 | 8.35 | 8.03 | 9.31 | 9.61 | 9.21 | 4.99 | 4.53 | 100.00 | 6.38 | 3.65 | 4.09 | 27.91 | 44.39 | 9.62 | 3.97 | | 100.00 | |

Wind Direction by Stability

| N | NNE | NE | ENE | E | ESE | SE | SSE | S | SSW | SW | WSW | W | WNW | NW | NNW | TOTAL | -STABILITY CLASSES- |
|------|------|------|------|------|------|------|------|------|------|------|------|------|------|------|------|-------|---------------------|
| 0.10 | 0.27 | 0.33 | 0.15 | 0.16 | 0.10 | 0.17 | 0.36 | 0.75 | 0.80 | 0.50 | 0.66 | 0.88 | 0.67 | 0.26 | 0.20 | 6.38 | Extremely Unstable |
| 0.10 | 0.12 | 0.17 | 0.14 | 0.09 | 0.08 | 0.12 | 0.22 | 0.30 | 0.43 | 0.44 | 0.27 | 0.33 | 0.43 | 0.14 | 0.27 | 3.65 | Moderately Unstable |
| 0.16 | 0.30 | 0.28 | 0.15 | 0.16 | 0.19 | 0.10 | 0.21 | 0.19 | 0.28 | 0.48 | 0.45 | 0.26 | 0.41 | 0.26 | 0.22 | 4.09 | Slightly Unstable |
| 1.37 | 1.59 | 1.89 | 1.01 | 0.73 | 0.75 | 1.27 | 1.68 | 1.96 | 2.26 | 2.62 | 2.45 | 2.57 | 2.54 | 1.58 | 1.61 | 27.91 | Neutral |
| 1.02 | 1.94 | 2.44 | 2.49 | 2.01 | 1.85 | 2.68 | 3.68 | 4.46 | 4.08 | 3.40 | 3.59 | 3.51 | 3.55 | 2.09 | 1.60 | 44.39 | Slightly Stable |
| 0.28 | 0.38 | 0.35 | 0.50 | 0.60 | 0.66 | 0.65 | 0.50 | 0.28 | 0.42 | 0.46 | 1.34 | 1.21 | 1.17 | 0.41 | 0.41 | 9.62 | Moderately Stable |
| 0.26 | 0.14 | 0.15 | 0.22 | 0.29 | 0.14 | 0.13 | 0.05 | 0.07 | 0.08 | 0.12 | 0.56 | 0.86 | 0.43 | 0.27 | 0.22 | 3.97 | Extremely Stable |

Wind Direction by Wind Speed

| N | NNE | NE | ENE | E | ESE | SE | SSE | S | SSW | SW | WSW | W | WNW | NW | NNW | TOTAL | -WIND SPEED CLASSES- |
|------|------|------|------|------|------|------|------|------|------|------|------|------|------|------|------|-------|----------------------|
| 0.00 | 0.02 | 0.05 | 0.01 | 0.00 | 0.00 | 0.00 | 0.00 | 0.02 | 0.00 | 0.00 | 0.00 | 0.00 | 0.01 | 0.01 | 0.01 | 0.14 | C A L M |
| 0.72 | 0.85 | 1.21 | 2.04 | 2.16 | 0.91 | 0.89 | 0.60 | 0.27 | 0.28 | 0.63 | 0.98 | 1.94 | 1.65 | 1.14 | 0.89 | 17.15 | 1.0- 3.5 mph |
| 1.34 | 2.51 | 2.76 | 2.46 | 1.66 | 2.21 | 2.64 | 3.19 | 2.47 | 1.58 | 2.42 | 4.41 | 4.10 | 3.69 | 1.88 | 1.66 | 40.99 | 3.6- 7.5 mph |
| 0.98 | 1.16 | 1.29 | 0.14 | 0.23 | 0.62 | 1.42 | 2.40 | 3.18 | 3.83 | 3.45 | 3.05 | 2.59 | 3.21 | 1.65 | 1.66 | 30.86 | 7.6-12.5 mph |
| 0.27 | 0.20 | 0.30 | 0.00 | 0.00 | 0.05 | 0.17 | 0.46 | 1.84 | 2.31 | 1.35 | 0.66 | 0.85 | 0.65 | 0.31 | 0.30 | 9.72 | 12.6-18.5 mph |
| 0.00 | 0.00 | 0.00 | 0.00 | 0.00 | 0.00 | 0.00 | 0.03 | 0.23 | 0.30 | 0.16 | 0.15 | 0.12 | 0.00 | 0.00 | 0.00 | 1.00 | 18.6-24.5 mph |
| 0.00 | 0.00 | 0.00 | 0.00 | 0.00 | 0.00 | 0.00 | 0.00 | 0.00 | 0.05 | 0.02 | 0.06 | 0.01 | 0.00 | 0.00 | 0.00 | 0.14 | >24.5 mph |

**BRAIDWOOD NUCLEAR POWER STATION
RADIOACTIVE EFFLUENT RELEASE REPORT FOR 2001
UNIT 1 AND 2 (Docket Numbers 50-456 and 50-457)**

APPENDIX C

Offsite Dose Calculation Manual

ComEd

Offsite

Dose

Calculation

Manual

Docket Numbers:

| | |
|--------------------|------------------------------|
| Dresden | 50-10, 50-237, 50-249 |
| Quad Cities | 50-254, 50-265 |
| Zion | 50-295, 50-304 |
| LaSalle | 50-373, 50-374 |
| Byron | 50-454, 50-455 |
| Braidwood | 50-456, 50-457 |

OFFSITE DOSE CALCULATION MANUAL

TABLE OF CONTENTS

Part 1: GENERIC SECTIONS

| <u>TABLE OF CONTENTS</u> | | <u>PAGE</u> |
|--------------------------|---|-------------|
| Chapter 1 | Introduction | 1 |
| Chapter 2 | Regulations and Guidelines | 2 |
| Chapter 3 | Pathways | 12 |
| Chapter 4 | Introduction to Methodology | 15 |
| Chapter 5 | Measurement | 29 |
| Chapter 6 | Implementation of Offsite Dose Assessment Program | 31 |
| Chapter 7 | References | 33 |
| Chapter 8 | Intentionally Left Blank | — |
| Chapter 9 | Intentionally Left Blank | — |
| Appendix A | Compliance Methodology | A-i |
| Appendix B | Models and Parameters for Airborne and Liquid Effluent Calculations | B-i |
| Appendix C | Generic Data | C-i |
| Appendix D | Intentionally Left Blank | — |
| Appendix E | Intentionally Left Blank | — |

Part 2: SITE SPECIFIC SECTIONS

| | |
|------------|--|
| Chapter 10 | Radiological Effluent Treatment and Monitoring |
| Chapter 11 | Radiological Environmental Monitoring Program |
| Chapter 12 | Radiological Effluent Technical Standards |
| Appendix F | Station Specific Data |

Note: Previous Chapter 6 was deleted and previous Chapter 8 was renumbered as Chapter 6.
Previous Chapter 7 was deleted and replaced by the references section.
Previous Chapter 9 was deleted.
Previous Appendix B and C have been combined into Appendix B.
Previous Appendix D has been revised into Appendix C.
Previous Appendix E has been deleted and is Reference 101.

OFFSITE DOSE CALCULATION MANUAL

TABLE OF CONTENTS (Continued)

| | <u>PAGE</u> |
|--|-------------|
| CHAPTER 1 INTRODUCTION | |
| 1.0 INTRODUCTION | 1 |
| 1.1 STRUCTURE OF THIS MANUAL | 1 |
| CHAPTER 2 REGULATIONS AND GUIDELINES | 2 |
| 2.0 INTRODUCTION | 2 |
| 2.1 CODE OF FEDERAL REGULATIONS | 2 |
| 1. 10CFR20, Standards for Protection Against Radiation | 2 |
| 2. Design Criteria (Appendix A of 10CFR50) | 2 |
| 3. ALARA Provisions (Appendix I of 10CFR50) | 2 |
| 4. 40CFR190, Environmental Radiation Protection Standards for Nuclear Power Operations | 3 |
| 5. 40CFR141, National Primary Drinking Water Regulations | 3 |
| 2.2 RADIOLOGICAL EFFLUENT TECHNICAL SPECIFICATIONS/STANDARDS | 3 |
| 1. Categories | 4 |
| 2.3 OFFSITE DOSE CALCULATION MANUAL | 4 |
| 2.4 OVERLAPPING REQUIREMENTS | 5 |
| 2.5 DOSE RECEIVER METHODOLOGY | 5 |
| CHAPTER 3 EXPOSURE PATHWAYS | 12 |
| 3.0 INTRODUCTION | 12 |
| 3.1 AIRBORNE RELEASES | 12 |
| 3.2 LIQUID RELEASES | 12 |
| 3.3 RADIATION FROM CONTAINED SOURCES | 13 |

OFFSITE DOSE CALCULATION MANUAL

TABLE OF CONTENTS (Continued)

| | <u>PAGE</u> |
|---|-------------|
| CHAPTER 4 METHODOLOGY | 15 |
| 4.0 INTRODUCTION | 15 |
| 4.1 IMPORTANT CONCEPTS AND PARAMETERS | 15 |
| 1. Dose and Dose Commitment | 15 |
| 2. Exposure Pathways | 15 |
| 3. Categories of Radioactivity | 16 |
| 4. Release Point Classifications | 16 |
| 5. Historical Average Atmospheric Conditions | 17 |
| 6. Relative Concentration Factor X/Q | 18 |
| 7. Relative Deposition Factor D/Q | 18 |
| 8. Dose Factors | 19 |
| 4.2 AIRBORNE RELEASES | 19 |
| 1. Gamma Air Dose | 19 |
| 2. Beta Air Dose | 19 |
| 3. Whole Body Dose and Dose Rate | 20 |
| 4. Skin Dose and Dose Rate | 21 |
| 5. Ground Radiation | 21 |
| 6. Inhalation | 22 |
| 7. Ingestion | 22 |
| 4.3 LIQUID RELEASES | 23 |
| 4.4 CONTAINED SOURCES OF RADIOACTIVITY | 24 |
| 1. BWR Skyshine | 24 |
| 2. Onsite Radwaste Storage Facilities | 24 |
| 4.5 TOTAL DOSE REQUIREMENTS | 25 |
| 1. Total Effective Dose Equivalent Limits of 10CFR20 | 25 |
| 2. Total Dose for Uranium Fuel Cycle | 25 |
| CHAPTER 5 MEASUREMENT | 29 |
| 5.0 INTRODUCTION | 29 |
| 5.1 EFFLUENT AND PROCESS MONITORING | 29 |
| 5.2 METEOROLOGICAL MONITORING | 29 |
| 5.3 RADIOLOGICAL ENVIRONMENTAL MONITORING PROGRAM | 29 |
| 1. Interlaboratory Comparison Program | 29 |

OFFSITE DOSE CALCULATION MANUAL

TABLE OF CONTENTS (Continued)

| | <u>PAGE</u> |
|---|-------------|
| CHAPTER 6 IMPLEMENTATION OF OFFSITE DOSE ASSESSMENT | 31 |
| 6.1 NUCLEAR POWER STATION | 31 |
| 6.2 METEOROLOGICAL CONTRACTOR | 31 |
| 6.3 REMP CONTRACTOR | 31 |
| 6.4 CORPORATE DEPARTMENTS | 31 |
| CHAPTER 7 REFERENCES | 33 |

OFFSITE DOSE CALCULATION MANUAL

LIST OF TABLES FOR THE ODCM GENERIC SECTIONS

| <u>SECTION</u> | <u>TABLE NUMBER</u> | <u>TITLE</u> |
|----------------|---------------------|---|
| Chapter 2 | 2-1 | Regulatory Dose Limit Matrix |
| | 2-2 | Dose Assessment Receivers |
| | 2-3 | Dose Component/Regulation Matrix |
| Chapter 4 | 4-1 | Radionuclide Types Considered For Airborne Effluent Exposure Pathways |
| | 4-2 | Radiation Dose Factors |
| Appendix A | A-1 | Compliance Matrix |
| | A-2 | Release Point Classifications |
| | A-3 | Nearest Downstream Community Water Systems |
| | A-4 | 40CFR190 Compliance |
| Appendix C | C-1 | Miscellaneous Dose Assessment Factors Environmental Parameters |
| | C-2 | Miscellaneous Dose Assessment Factors Consumption Rate Parameters |
| | C-3 | Stable Element Transfer Data |
| | C-4 | Atmospheric Stability Classes |
| | C-5 | Vertical Dispersion Parameters |
| | C-6 | Allowable Concentrations of Dissolved or Entrained Noble Gases Released from the Site to Unrestricted Areas in Liquid Waste |
| | C-7 | Radiological Decay Constants (λ_i) in hr^{-1} |
| | C-8 | Bio-accumulation Factors B_i to be Used in the Absence of Site-Specific Data |
| | C-9 | Beta Air and Skin Dose Factors for Noble Gases |
| | C-10 | External Dose Factors for Standing on Contaminated Ground |
| | C-11 | Sector Code Definitions |
| | C-12 | Exposure to Dose Conversion Factors for Inhalation |
| | C-13 | Exposure to Dose Conversion Factors for Ingestion |

LIST OF FIGURES FOR THE ODCM GENERIC SECTIONS

| <u>SECTION</u> | <u>FIGURE NUMBER</u> | <u>TITLE</u> |
|----------------|----------------------|--|
| Chapter 2 | 2-1 | Simplified Flow Chart of Offsite Dose Calculations |
| Chapter 3 | 3-1 | Radiation Exposure Pathways to Humans |

CHAPTER 1

1.0 Introduction

The Offsite Dose Calculation Manual (ODCM) presents a discussion of the following:

- The basic concepts applied in calculating offsite doses from nuclear plant effluents.
- The regulations and requirements for the ODCM and related programs
- The methodology and parameters for the offsite dose calculations used by the nuclear power stations to assess impact on the environment and compliance with regulations.

The methodology detailed in this manual is intended for the calculation of radiation doses during routine (i.e., non-accident) conditions. The calculations are normally performed using a computer program. Manual calculations may be performed in lieu of the computer program.

The dose effects of airborne radioactivity releases predominately depend on meteorological conditions (wind speed, wind direction, and atmospheric stability). For airborne effluents, the dose calculations prescribed in this manual are based on historical average atmospheric conditions. This methodology is appropriate for estimating annual average dose effects and is stipulated in the Bases Section of the Radiological Effluent Technical Standards (RETS) of all ComEd nuclear power stations.

1.1 STRUCTURE OF THIS MANUAL

This manual is the ODCM for all ComEd nuclear power stations. It is divided into two parts. The material in the first part is generic (applicable to more than one station) and consists of Chapters 1 through 7 and Appendices A through C. The material in the second part is station (or site) specific. Therefore, there are six separate sets of station-specific sections each containing three chapters (chapters 10, 11, 12) and an appendix (App. F).

The chapters of the generic section provide a brief introduction to and overview of ComEd's offsite dose calculation methodology and parameters. The generic section appendices, Appendices A and B, provide detailed information on specific aspects of the methodology. Appendix C contains tables of values of the generic parameters used in offsite dose equations.

The station-specific section provides specific requirements for the treatment and monitoring of radioactive effluents, for the contents of the Radiological Environmental Monitoring Program (REMP) and the Radiological Effluent Technical Standards (RETS). These three programs are detailed in ODCM Chapters 10, 11 and 12 respectively. Appendix F contains tables of values for the station-specific parameters used in the offsite dose equations. References are provided as required in each station-specific chapter and appendix.

An ODCM Bases and Reference Document (see Reference 101) provides description of the bases for the methodology and parameters discussed in the generic section of the ODCM. This is a stand-alone document and is not considered to be a part of the ODCM.

CHAPTER 2

REGULATIONS AND GUIDELINES

2.0 INTRODUCTION

This chapter of the ODCM serves to illustrate the regulations and requirements that define and are applicable to the ODCM. Any information provided in the ODCM concerning specific regulations are not a substitute for the regulations as found in the CFR or Technical Specifications.

2.1 CODE OF FEDERAL REGULATIONS

Various sections of the Code of Federal Regulations (CFR) require nuclear power stations to be designed and operated in a manner that limits the radiation exposure to members of the public. These sections specify limits on offsite radiation doses and on effluent radioactivity concentrations and they also require releases of radioactivity to be "As Low As Reasonably Achievable". These requirements are contained in 10CFR20, 10CFR50 and 40CFR190. In addition, 40CFR141 imposes limits on the concentration of radioactivity in drinking water provided by the operators of public water systems.

2.1.1 10CFR20, Standards for Protection Against Radiation

This revision of the ODCM addresses the requirements of 10CFR20. The 10CFR20 dose limits are summarized in Table 2-1.

2.1.2 Design Criteria (Appendix A of 10CFR50)

Section 50.36 of 10CFR50 requires that an application for an operating license include proposed Technical Specifications. Final Technical Specifications for each station are developed through negotiation between the applicant and the NRC. The Technical Specifications are then issued as a part of the operating license, and the licensee is required to operate the facility in accordance with them.

Section 50.34 of 10CFR50 states that an application for a license must state the principal design criteria of the facility. Minimum requirements are contained in Appendix A of 10CFR50.

2.1.3 ALARA Provisions (Appendix I of 10CFR50)

Sections 50.34a and 50.36a of 10CFR50 require that the nuclear plant design and the station RETS have provisions to keep levels of radioactive materials in effluents to unrestricted areas "As Low As Reasonably Achievable" (ALARA). Although 10CFR50 does not impose specific limits on releases, Appendix I of 10CFR50 does provide numerical design objectives and suggested limiting conditions for operation. According to Section I of Appendix I of 10CFR50, design objectives and limiting conditions for operation, conforming to the guidelines of Appendix I "shall be deemed a conclusive showing of compliance with the "As Low As Reasonably Achievable" requirements of 10CFR50.34a and 50.36a."

An applicant must use calculations to demonstrate conformance with the design objective dose limits of Appendix I. The calculations are to be based on models and data such that the actual radiation exposure of an individual is "unlikely to be substantially underestimated" (see 10CFR50 Appendix I, Section III.A.1)

The guidelines in Appendix I call for an investigation, corrective action and a report to the NRC whenever the calculated dose due to the radioactivity released in a calendar quarter exceeds one-half of an annual design objective. The guidelines also require a surveillance program to monitor releases, monitor the environment and identify changes in land use.

2.1.4 40CFR190, Environmental Radiation Protection Standards for Nuclear Power Operations

Under an agreement between the NRC and the EPA, the NRC stipulated to its licensees in Generic Letter 79-041 that "Compliance with Radiological Effluent Technical Specifications (RETS), NUREG-0472 (Rev.2) for PWR's or NUREG-0473 (Rev.2) for BWR's, implements the LWR provisions to meet 40CFR190". (See Reference 103 and 49.)

The regulations of 40CFR190 limit radiation doses received by members of the public as a result of operations that are part of the uranium fuel cycle. Operations must be conducted in such a manner as to provide reasonable assurance that the annual dose equivalent to any member of the public due to radiation and to planned discharges of radioactive materials does not exceed the following limits:

- 25 mrem to the whole body
- 75 mrem to the thyroid
- 25 mrem to any other organ

An important difference between the design objectives of 10CFR50 and the limits of 40CFR190 is that 10CFR50 addresses only doses due to radioactive effluents. 40CFR190 limits doses due to effluents and also to radiation sources maintained on site. See Section 2.4 for further discussion of the differences between the requirements of 10CFR50 Appendix I and 40CFR190.

2.1.5 40CFR141, National Primary Drinking Water Regulations

The following radioactivity limits for community water systems were established in the July, 1976 Edition of 40CFR141:

- Combined Ra-226 and Ra-228: ≤ 5 pCi/L.
- Gross alpha (particle activity including Ra-226 but excluding radon and uranium): ≤ 15 pCi/L.
- The average annual concentration of beta particle and photon radioactivity from man-made radionuclides in drinking water shall not produce an annual dose equivalent to the whole body or any internal organ greater than 4 mrem/yr.

The regulations specify procedures for determining the values of annual average radionuclide concentration which produce an annual dose equivalent of 4 mrem. Radiochemical analysis methods are also specified. The responsibility for monitoring radioactivity in a community water system falls on the supplier of the water. However, some of the ComEd stations have requirements related to 40CFR141 in their specific RETS. For calculational methodology, see Section A.6 of Appendix A.

2.2 RADIOLOGICAL EFFLUENT TECHNICAL STANDARDS

The Radiological Effluent Technical Standards (RETS) were formerly a subset of the Technical Specifications. They implement provisions of the Code of Federal Regulations aimed at limiting offsite radiation dose. The NRC published Standard Radiological Effluent Technical Specifications for PWRs (Reference 2) and for BWRs (Reference 3) as guidance to assist in the development of technical specifications. These documents have undergone frequent minor revisions to reflect changes in plant design and evolving regulatory concerns. The Radiological Effluent Technical Specifications have been removed from the Technical Specifications and placed in the ODCM as the Radiological Effluent Technical Standards (RETS) (see Reference 90). The RETS of each station are similar but not identical to the guidance of the Standard Radiological Effluent Technical Specifications.

2.2.1 Categories

The major categories found in the RETS are the following:

- **Definitions**
A glossary of terms (not limited to the ODCM).
- **Instrumentation**
This section states the Operability Requirements (OR) for instrumentation performance as well as the associated Surveillance Requirements. The conservative alarm/trip setpoints ensure regulatory compliance for both liquid and gaseous effluents. Surveillance requirements are listed to ensure ORs are met through testing, calibration, inspection and calculation. Also included are the bases for interpreting the requirements. The Operability Requirement (OR) is the ODCM equivalent of a Limiting Condition for Operation (LCO) as defined in both the NRC published Standard Radiological Effluent Technical Specifications and the stations' Technical Specifications.
- **Liquid Effluents**
This section addresses the limits, special reports and liquid waste treatment systems required to substantiate the dose due to liquid radioactivity concentrations to unrestricted areas. Surveillance Requirements and Bases are included for liquid effluents.
- **Gaseous Effluents**
This section addresses the limits, special reports and gaseous radwaste and ventilation exhaust treatment systems necessary for adequate documentation of the instantaneous offsite radiation dose rates and doses to a member of the public. Surveillance Requirements and Bases are included for gaseous effluents.
- **Radiological Environmental Monitoring Program**
This section details the Radiological Environmental Monitoring Program (REMP) involving sample collection and measurements to verify that the radiation levels released are minimal. This section describes the annual land use census and participation in an interlaboratory comparison program. Surveillance Requirements and Bases are included for environmental monitoring.
- **Reports and Records**
This section serves as an administrative guide to maintain an appropriate record tracking system. The management of procedures, record retention, review/audit and reporting are discussed.

2.3 OFFSITE DOSE CALCULATION MANUAL

The NRC in Generic Letter 89-01 defines the ODCM as follows (not verbatim) (see Reference 90):

The Offsite Dose Calculation Manual (ODCM) shall contain the methodology and parameters used in the calculation of offsite doses resulting from radioactive gaseous and liquid effluents, in the calculation of gaseous and liquid effluent monitoring Alarm/Trip Setpoints, and in the conduct of the Radiological Environmental Monitoring Program. The ODCM shall also contain (1) the Radioactive Effluent Controls and Radiological Environmental Monitoring Programs and (2) descriptions of the Information that should be included in the Annual Radiological Environmental Operating and Annual Radioactive Effluent Release Reports.

Additional requirements for the content of the ODCM are contained throughout the text of the RETS.

2.4 OVERLAPPING REQUIREMENTS

In 10CFR20, 10CFR50 and 40CFR190, there are overlapping requirements regarding offsite radiation dose and dose commitment to the whole body. In 10CFR20.1301 the total effective dose equivalent to a member of the public is limited to 100 mrem per calendar year. In addition, Appendix I to 10CFR50 establishes design objectives on annual total body dose or dose commitment of 3 mrem per reactor for liquid effluents and 5 mrem per reactor for gaseous effluents (see 10CFR50 Appendix I, Sections II.A and II.B.2(a)). Finally, 40CFR190 limits annual whole body dose or dose commitment to a member of the public to 25 mrem due to all uranium fuel cycle operations.

While these dose limits/design objectives appear to overlap, they are different and each is addressed separately by the RETS. Calculations are made and reports are generated to demonstrate compliance to all regulations. Refer to Tables 2-1, 2-2 and 2-3 for additional information regarding instantaneous effluent limits, design objectives and regulatory compliance.

2.5 Dose Receiver Methodology

Table 2-2 lists the location of the dose recipient and occupancy factors, if applicable. In general, the dose receiver spends time in the locations that result in maximum direct dose exposure and inhales and ingests radioactivity at locations that yield maximum pathway doses. Thus, the dose calculated is very conservative compared to the "average" (or typical) dose recipient who does not go out of the way to maximize radioactivity uptakes and exposure.

Finally Table 2-3 relates the dose component (or pathway) to specific ODCM equations and the appropriate regulation.

Table 2-1
Regulatory Dose Limit Matrix

| REGULATION | DOSE TYPE | DOSE LIMIT(s) | | ODCM EQUATION | |
|-----------------------------------|--|--|----------|---------------|-----|
| | | (quarterly) | (annual) | | |
| Airborne Releases: | | | | | |
| 10CFR50 App. I ³ | Gamma Dose to Air due to Noble Gas Radionuclides (per reactor unit) | 5 mrad | 10 mrad | A-1 | |
| | Beta Dose to Air Due to Noble Gas Radionuclides (per reactor unit) | 10 mrad | 20 mrad | A-2 | |
| | Organ Dose Due to Specified Non-Noble Gas Radionuclides (per reactor unit) | 7.5 mrem | 15 mrem | A-13 | |
| | Total Body and Skin Dose (if air dose is exceeded) | Total Body | 2.5 mrem | 5 mrem | A-6 |
| | | Skin | 7.5 mrem | 15 mrem | A-7 |
| Technical Specifications | Whole Body Dose Rate Due to Noble Gas Radionuclides (instantaneous limit, per site) | 500 mrem/yr | | A-8 | |
| | Skin Dose Rate Due to Noble Gas Radionuclides (instantaneous limit, per site) | 3,000 mrem/yr | | A-9 | |
| | Organ Dose Rate Due to Specified Non-Noble Gas Radionuclides (instantaneous limit, per site) | 1,500 mrem/yr | | A-28 | |
| Liquid Releases: | | | | | |
| 10CFR50 App. I ³ | Whole (Total) Body Dose (per reactor unit) | 1.5 mrem | 3 mrem | A-29 | |
| | Organ Dose (per reactor unit) | 5 mrem | 10 mrem | A-29 | |
| Technical Specifications | The concentration of radioactivity in liquid effluents released to unrestricted areas | Ten (10) times the concentration values listed in 10CFR20 Appendix B; Table 2, Column 2, Table C-6 of Appendix C for Noble Gases | | A-32 | |
| Total Doses ¹: | | | | | |
| 10 CFR 20.1301 (a)(1) | Total Effective Dose Equivalent | 100 mrem/yr | | A-38 | |
| 10CFR20.1301 (d) and 40CFR190 | Whole Body Dose | 25 mrem/yr | | A-35 | |
| | Thyroid Dose | 75 mrem/yr | | A-37 | |
| | Other Organ Dose | 25 mrem/yr | | A-37 | |
| Other Limits ²: | | | | | |
| 40CFR141 | Whole Body Dose Due to Drinking Water From Public Water Systems | 4 mrem/yr | | A-30 | |
| | Organ Dose Due to Drinking Water From Public Water Systems | 4 mrem/yr | | A-30 | |

¹ These doses are calculated considering all sources of radiation and radioactivity in effluents.

- ² These limits are not directly applicable to nuclear power stations. They are applicable to the owners or operators of public water systems. However, the RETS of some of the ComEd nuclear power stations require assessment of compliance with these limits. For additional information, see Section A.6 of Appendix A.
- ³ Note that 10CFR50 provides design objectives not limits.

TABLE 2-2
DOSE ASSESSMENT RECEIVERS

| Dose Component or Pathway | Location; Occupancy if Different than 100% |
|--|--|
| "Instantaneous" dose rates from airborne radioactivity | Unrestricted area boundary location that results in the maximum dose rate |
| "Instantaneous" concentration limits in liquid effluents | Point where liquid effluents enter the unrestricted area |
| Annual average concentration limits for liquid effluents | Point where liquid effluents enter the unrestricted area |
| Direct dose from contained sources | Receiver spends part of this time in the controlled area and the remainder at his residence or fishing nearby; occupancy factor is considered and is site-specific. See Appendix F, Table F-8 for occupancy factors. |
| Direct dose from airborne plume | Receiver is at the unrestricted area boundary location that results in the maximum dose. |
| Direct dose from radioactivity deposited on the ground | Receiver is at the unrestricted area boundary location with the highest D/Q. |
| Inhalation dose from airborne effluents | Receiver is at the unrestricted area boundary location that results in maximum dose. |
| Ingestion dose from vegetables | Receiver eats vegetables from the garden at the nearest residence with the highest D/Q |
| Ingestion dose from milk | Receiver drinks milk from the near-site dairy farm with the highest D/Q |
| Ingestion dose from meat | Receiver eats meat produced at the near-site farm with the highest D/Q |
| Ingestion dose from drinking water ¹ | The drinking water pathway is considered as an additive dose component in this assessment only if the public water supply serves the community immediately adjacent to the plant. |
| Ingestion dose from eating fish | The receiver eats fish from the receiving body of water (lake or river) |
| Total Organ Doses | Summation of ingestion/inhalation doses |
| Total Effective Dose Equivalent | Summation of above data |

¹ At present, only the Braidwood and Zion station assessments include the drinking water pathway for 10CFR20 compliance.

TABLE 2-3
DOSE COMPONENT/REGULATION MATRIX

| Dose Component or Pathway | Reference equation; Comments | Regulation in which dose component is utilized | | |
|--|--|--|----------|------------------|
| | | 10CFR20 | 40CFR190 | 10CFR50 App. I |
| "Instantaneous" dose rates from airborne radioactivity | A-8: Whole body A-9: Skin A-28: Organ | X(2) | | |
| "Instantaneous" concentration limits in liquid effluents | Ten times the limits of Table 2, Col. 2, 10CFR20, Appendix B to §§20.1001 – 20.2402, Table C-6 of Appendix C for Noble Gases | X(2) | | |
| Annual average concentration limits for liquid effluents | 10CFR20, Appendix B to §§20.1001 – 20.2402(2) | X(3) | | |
| Direct dose from contained sources | A-34 | X | X | |
| Direct dose from airborne plume | A-1: Gamma air dose A-2: Beta air dose A-6: Whole body dose A-7: Skin dose | X | X | X X X X |
| Direct dose from radioactivity deposited on the ground | A-14 | X | X | X |
| Inhalation dose from airborne effluents | A-17 (1) | X | X | X |
| Ingestion dose from vegetables | A-23 and A-18 (1) | X | X | X |
| Ingestion dose from milk | A-25 and A-18 (1) | X | X | X |
| Ingestion dose from meat | A-27 and A-18 (1) | X | X | X |
| Ingestion dose from drinking water | A-30 (1) | X | X | X |
| Ingestion dose from eating fish | A-31 (1) | X | X | X |
| Total Organ Doses | A-13 | | X | X |
| Total Effective Dose Equivalent | A-38 | X | | |

- 1 Ingestion/inhalation dose assessment is evaluated for adult/teen/child and infant for 10CFR50 Appendix I compliance and for an adult for 10CFR20/40CFR190 compliance. Ingestion/inhalation dose factors are taken from Reg. Guide 1.109 (Reference 6) for 10CFR50 Appendix I compliance and FGR-11 (Reference 93) for 10CFR20/40CFR190 compliance.
- 2 Technical Specifications for most stations have been revised to allow 10 times the 10CFR20 value or specifically states the maximum instantaneous dose rate limit.
- 3 Optional for 10CFR20 compliance.

Figure 2-1

Simplified Chart of Offsite Dose Calculations²

| Category | Radionuclides | Pathway | Text Section | Receptor | Code and Limits | Frequency of Calculation ¹ |
|-------------------------------|------------------|---|---------------------------|-----------------------------------|---|---------------------------------------|
| Airborne Releases: | Noble Gases: | Plume γ^a | A.1.3.1 | Total Body | RETS: 500 mrem/yr Instantaneous | As Required by |
| | Noble Gases: | Plume γ^a and β^b | A.1.3.2 | Skin | RETS: 3000 mrem/yr Instantaneous | Station Procedure |
| | Noble Gases: | Plume γ^a | A.1.2.1 | | 10CFR50 ³ : 5 mrad/qtr, 10 mrad/yr | |
| | Noble Gases: | Plume β^b | A.1.2.2 | Air ⁴ | 10CFR50 ³ : 10 mrad/qtr, 20 mrad/yr | Monthly |
| | Non-Noble Gases: | Inhalation ^b | A.1.5 | Adult (Any Organ) | RETS: 1500 mrem/yr Instantaneous | As required by Station Procedure |
| | Non-Noble Gases: | Ground Deposition ^c | A.1.4.1 | Whole body | | |
| Inhalation | | A.1.4.2 | | | | |
| Leafy Vegetables ^c | | A.1.4.3.1 | 4 Age groups (All Organs) | | 10CFR50 ³ : 7.5 mrem/qtr, 15 mrem/yr | Monthly and Annually |
| Produce ^c | | A.1.4.3.1 | | | | |
| Milk ^d | | A.1.4.3.2 | | | | |
| Meat ^d | A.1.4.3.3 | | | | | |
| Liquid Releases: | All | Water | A.2.2 | | RETS, 10 times 10CFR20 Appendix B; Table 2; Col. 2, Table C-6 of Appendix C for Noble Gases | As Required by Station Procedure |
| | Non-Noble Gases | Water ^e and Fish ^f | A.2.1 | Whole Body | 10CFR50 ³ : 1.5 mrem/qtr 3 mrem/yr | |
| | Non-Noble Gases | Water ^e and Fish ^f | A.2.1 | 4 Age Groups (All Organs) | 10CFR50 ³ : 5 mrem/qtr 10 mrem/yr | Monthly |
| | Non-Noble Gases | Water ^e | A.6 | Adult (Whole Body and all Organs) | 40CFR141: 4 mrem/yr | When Required by RETS |
| Uranium Fuel Cycle: | All | All releases plus direct radiation from contained sources | A.3 | Whole Body | 40CFR190: 25 mrem/yr | |
| | | | | Thyroid (Adult) | 40CFR190: 75 mrem/yr | Annually |
| | | | | All Other Organs (Adult) | 40CFR190: 25 mrem/yr | |
| TEDE: | All | External (DDE) + Internal (CEDE) | A.4.3 | Total Body + organs (Adult) | 10CFR20: 100 mrem/yr | Annually |

Figure 2-1 (Cont'd)

Notes for Figure 2-1:

1. Definition: Monthly means at least once per 31 days or once per month. See station RETS for exact requirements.
2. Additional Calculations: In addition to the calculations shown in this figure, monthly projections of doses due to radioactive materials are required for gaseous and liquid effluents from ComEd nuclear power stations. See Sections A.1.6 and A.2.5 of Appendix A.

Also, projections of drinking water doses are required at least once per 92 days for Dresden and Quad Cities. See Section A.7 of Appendix A.
3. 10 CFR 50 prescribes design objectives not limits.
4. If the air dose is exceeded, doses to the total body and skin are calculated. Total body objectives are 2.5 mrem/qtr and 5.0 mrem/year; the skin dose objectives are 7.5 mrem/qtr and 15 mrem/year.
 - a. Evaluated at the unrestricted area boundary.
 - b. Evaluated at the location of maximum offsite X/Q.
 - c. Evaluated at the location of maximum offsite D/Q.
 - d. Evaluated for the nearest producer within 5 miles or if there is none a hypothetical producer at 5 miles.
 - e. Evaluated for the nearest downstream community water supply as specified in Table A-3 of Appendix A. The flow and dilution factors specified in Table F-1 of Appendix F are used.
 - f. Evaluated for fish caught in the near-field region downstream of plant using the flow and dilution factors specified in Table F-1 of Appendix F.

CHAPTER 3

EXPOSURE PATHWAYS

3.0 INTRODUCTION

Figure 3-1 illustrates some of the potential radiation exposure pathways to humans due to routine operation of a nuclear power station. These exposure pathways may be grouped into three categories:

- **Airborne Releases**
Exposures resulting from radioactive materials released with gaseous effluents to the atmosphere.
- **Liquid Releases**
Exposures resulting from radioactive materials released with liquid discharges to bodies of water.
- **Radiation from Contained Sources**
Exposures to radiation from contained radioactive sources.

When performing radiation dose calculations, only exposure pathways that significantly contribute ($\geq 10\%$) to the total dose of interest need to be evaluated. The radiation dose from air and water exposure pathways are routinely evaluated. (see Regulatory Guide 1.109, Reference 6.)

3.1 AIRBORNE RELEASES

For airborne releases of radioactivity (Figure 3-1), the NRC considers the following pathways of radiation exposure of persons:

- Radiation from radioactivity airborne in the effluent plume.
- Radiation from radioactivity deposited by the plume on the ground.
- Ingestion of radioactivity on, or in, edible vegetation (from direct plume deposition or from the transfer of radioactivity deposited on the soil).
- Ingestion of radioactivity that entered an animal food product (milk or meat) because the animal ingested contaminated feed, with the contamination due either to direct deposition on foliage or to uptake from the soil.
- Inhalation of radioactivity in the plume.

ComEd considers these same pathways with the exception that the transfer of radioactivity from soil to vegetation is omitted. This pathway was determined to be of minimal significance in relation to the other airborne exposure pathways.

3.2 LIQUID RELEASES

For liquid releases of radioactivity (Figure 3-1), the NRC considers the following pathways of radiation exposure of persons:

- Direct exposure to radioactivity in water while engaging in recreational activities such as swimming and boating.
- Exposure to radiation from shoreline sediments contaminated by water containing radioactivity from station liquid discharges.
- Ingestion of edible vegetation contaminated by irrigation with water containing radioactivity from station liquid discharges.

- Ingestion of radioactivity from animal food products (milk or meat) resulting from the animal either drinking water contaminated by radioactive liquid effluents or from the animal eating feed or vegetation contaminated by irrigation with such water.
- Ingestion of aquatic food (e.g., fish) obtained from the body of water to which radioactive station effluents are discharged.
- Ingestion (drinking) of potable water contaminated by radioactive liquid effluents discharged from the station.

ComEd considers the latter two of these pathways as significant. For the aquatic food pathway, only fish is considered since it is the only significant locally produced aquatic food consumed by humans.

The stations omit the pathways involving irrigation and animal consumption of contaminated water because these pathways were determined to be insignificant. The stations also omit the pathway of radiation exposure from shoreline sediment because this pathway was also found to be insignificant (see ODCM Bases and Reference Document, Section O.3.2).

The stations have also verified that the dose contribution to people participating in water recreational activities (swimming and boating) is negligible. (See ODCM Bases and Reference Document, Reference 101, Tables O-3 and O-4) This pathway was not addressed explicitly in Regulatory Guide 1.109. Thus, the stations also omit dose assessments for the water recreational activities pathway.

Periodically the Illinois Army Corps of Engineers dredges silt and debris from the river beds near ComEd nuclear stations. As a part of the land use census, ComEd will determine if the Corps performed dredging within one mile of the discharge point. If so, ComEd will obtain spoils samples, through it's REMP vendor, for analysis. The impact to the offsite dose will be evaluated on a case by case basis and added to the station annex of the ODCM when applicable.

In addition, to assure that doses due to radioactivity in liquid effluents will be ALARA, concentrations will be limited to ten times (10x) the values given in 10CFR20 Appendix B, Table 2; Column 2. Specific limitations for concentrations of entrained noble gases are contained in the stations' Radiological Effluent Technical Standards (RETS).

3.3 RADIATION FROM CONTAINED SOURCES

Radioactivity contained within tanks, pipes or other systems and contained radioactive material or waste stored on site can produce radiation at offsite locations. Annual offsite radiation doses near the stations due to such sources were judged to be negligible in comparison with applicable limits except for doses due to BWR turbine skyshine and potential doses due to radioactive waste storage facilities (excludes radioactive material storage). See ODCM Bases and Reference Document, Reference 101. Changes or modifications to the power station that may impact the offsite dose through increases to the direct radiation levels need to be evaluated on a case by case basis and added to Chapter 12 of the station annex to the ODCM when applicable (e.g.; the Old Steam Generator Storage Facilities).

Figure 3-1

Radiation Exposure Pathways to Humans

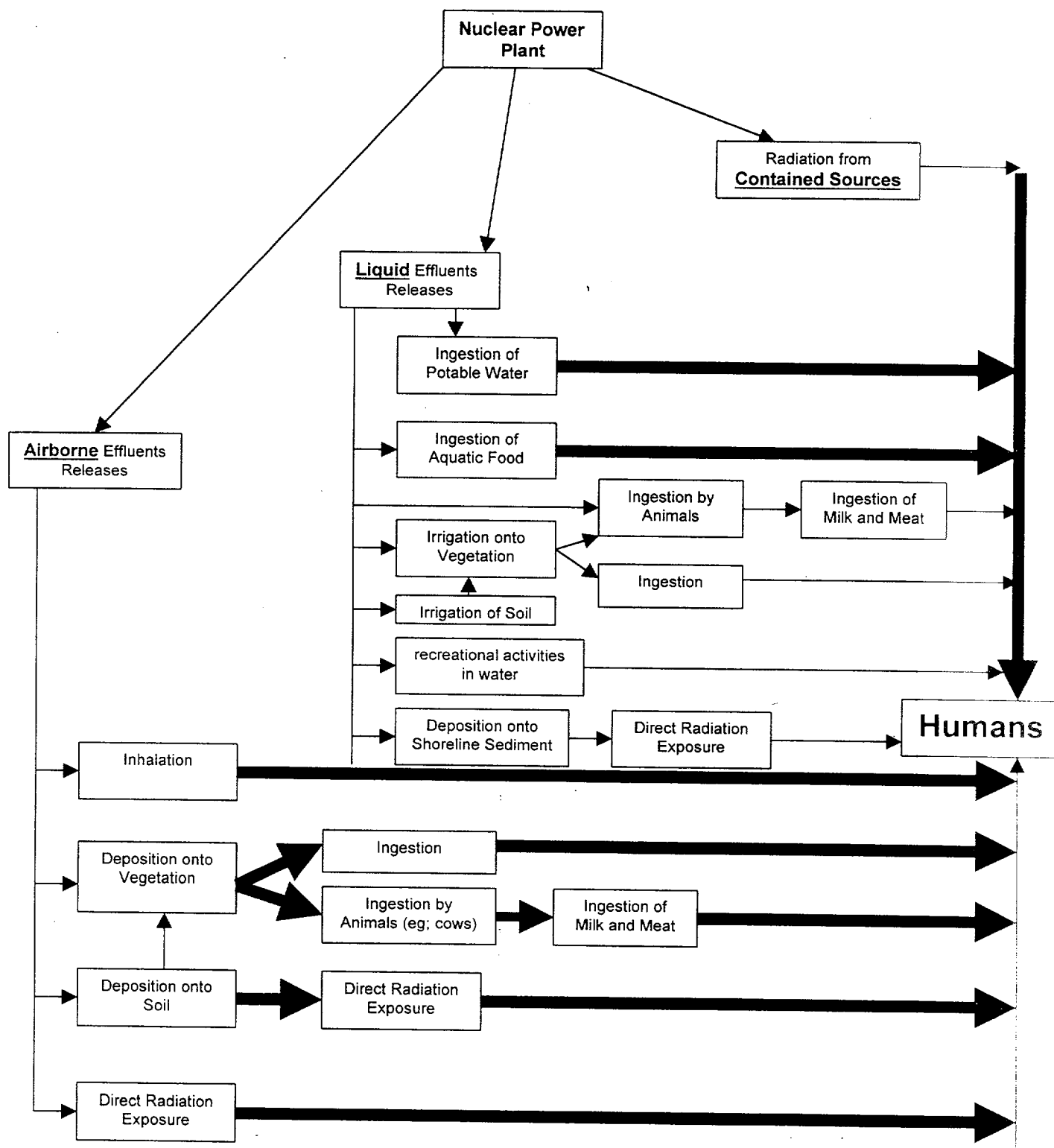

CHAPTER 4

METHODOLOGY

4.0 INTRODUCTION

This chapter provides an introduction to the methodology used by ComEd to calculate offsite radiation doses resulting from the operation of nuclear power stations. Additional explanation and details of the methodology are provided in Appendices A and B. Appendix A discusses each dose limit in the RETS and provides the associated assessment equations. Appendix B describes methods used to determine values of parameters included in the equations.

4.1 IMPORTANT CONCEPTS AND PARAMETERS

4.1.1 Dose and Dose Commitment

The dose calculation equations contained in the ODCM are based on two types of exposure to radiation: external and internal exposure. The first type of exposure is that resulting from radioactive sources external to the body (including radiation emanating from an effluent plume, radiation emanating from radioactivity deposited on the ground and radiation emanating from contained sources (also referred to as direct radiation)). Exposure to radiation external to the body only occurs while the source of the radioactivity is present. For example, once a plume containing the airborne radioactivity passes by the individual, the external exposure to radiation ends.

The second type of exposure occurs when the source of radioactivity is inside the body, or internal. Radiation can enter the body by breathing air containing the radioactivity, or by eating food or drinking water containing radioactivity. These latter processes are also referred to as ingesting radioactivity (ingestion). Once radioactivity enters the body and becomes internal radiation, a person will continue to receive radiation dose until the radioactivity has decayed or is eliminated by biological processes. The dose from this type of exposure is also termed dose commitment, meaning that the person will continue to receive dose even-though the plume containing the radioactivity has passed by the individual, or even-though the individual is no longer drinking water containing radioactivity.

The regulations addressed by the ODCM may require assessment of either type of exposure to radiation or of both types in summation.

4.1.2 Exposure Pathways

All of the exposure pathways are discussed in Chapter 3. This section presents the exposure pathways addressed by ComEd nuclear stations in the ODCM and associated software.

For releases of radioactivity in airborne effluents the primary pathways are the following:

- Direct radiation from an effluent plume.
- Direct radiation from radioactivity deposited on the ground by a plume.
- Inhalation of radioactivity in a plume.
- Ingestion of radioactivity that entered the food chain from a plume that deposited the radioactivity on vegetation.

For releases of radioactivity in liquid effluents, the exposure pathways considered are human consumption of water and fish.

When determining total doses, as required by 10CFR20 and 40CFR190, the BWR stations also consider direct radiation due to skyshine from nitrogen-16 (N^{16}) in turbines and associated piping. All nuclear

power stations will consider exposure to radiation emanating from onsite radwaste storage facilities when they are put into operation.

4.1.3 Categories of Radioactivity

Radionuclide content of effluent releases from nuclear power stations can be categorized according to the characteristics of the radionuclides. In evaluating doses associated with a particular pathway, only those categories of radionuclides that significantly contribute to the dose need to be included in the dose calculations (See Section 3.0). The categories of radionuclides considered by the ComEd nuclear power stations for each of the airborne pathways are summarized in Table 4-1. Selection of the significant airborne pathways was based on the following:

- The requirements in the RETS (see discussion in Appendix A)
- Applicable regulatory guidance (References 6 and 14), and
- A study of the potential radiological implications of nuclear facilities in the upper Mississippi River basin (Reference 20).

Calculations were used to determine which radionuclides were significant for a particular pathway. For example, in the case of direct radiation from a plume of airborne radioactivity, it was found that radiation from noble gases is significant and radiation from radioactive iodine was not. The dose rate per unit of airborne radioactivity concentration is about the same for noble gases and radioactive iodine since they emit comparable types and energies of radiation. However, the quantity of noble gas radioactivity (Ci) released in routine nuclear plant operation typically exceeds the quantity of radioactive iodine by a factor of about 10,000.

As another example, consider the inhalation pathway. Here, the calculations showed that the dose commitment due to radioactive iodine was significant but the dose commitment due to radioactive noble gases was not significant and can be excluded from the compliance calculations for the inhalation pathway. This is true despite the fact that a much larger quantity of noble gas radioactivity is released. The reason for this is that the solubility of noble gas in body tissue is very low, where-as the inhaled radioactive iodine does concentrate in specific body organs such as the thyroid (see the discussion on Pages 228 and 231 to 234 of Reference 38).

4.1.4 Release Point Classifications

In the determination of the dose consequence from an airborne release of radioactivity, it is required to know the height of the release of the effluent plume relative to the ground and where the dose recipients are located. This correlation is very important because the radiation dose calculated is greatly impacted by the distance separating the dose recipient and the radioactive plume.

It has been found that the height an effluent plume maintains as it travels above the ground is related to the elevation of the release point and to the height of structures immediately adjacent as follows:

- If the elevation of the release point is sufficiently above the height of any adjacent structures, the plume will remain elevated for considerable distances.
- If the elevation of the release point is at or below the heights of adjacent structures, the plume is likely to be caught in the turbulence of the wakes created by wind passing over the buildings. The plume elevation would then drop to ground level.
- If the elevation of the release point is not significantly above the heights of adjacent structures, then the plume may be elevated or at ground level.

For the calculations of this manual, each established release point has been designated as belonging to one of three release point classifications:

- Stack (or Elevated) Release Points (denoted by the letter S or subscript s)

These are release points approximately twice the height of adjacent solid structures. Releases are treated as elevated releases unaffected by the presence of the adjacent structures.
- Ground Level Release Points (denoted by the letter G or subscript g)

These are release points at ground level or lower than adjacent solid structures. Releases are considered drawn into the downwind wake of these structures and are treated as ground level releases.
- Vent (or Mixed Mode) Release Points (denoted by the letter V or subscript v)

These are release points as high or higher than adjacent solid structures but lower than twice the structure's heights. These releases are treated as a mixture of elevated and ground level releases. The proportion of the release attributed to either elevated or ground level in a vent release is determined by the ratio of stack exit velocity to the wind speed (see Section B.1.2.4 of Appendix B).

The definitions of these classifications are based on Regulatory Guide 1.111 (Reference 7). A list of the classifications of specific airborne release points for each of the ComEd nuclear power stations is contained in Table A-2 in Appendix A.

4.1.5 Historical Average Atmospheric Conditions

The dispersion characteristics of airborne effluents from a nuclear power station are dependent on weather conditions. Meteorological factors that directly affect the concentration of airborne radioactivity in a plume include the following:

- Wind Direction

The concentration of radioactivity is highest in the direction toward which the wind is blowing.
- Wind Speed

Greater wind speeds produce more dispersion and consequently lower concentrations of radioactivity.
- Atmospheric Turbulence

The greater the atmospheric turbulence, the more a plume spreads both vertically and horizontally. For calculations in this manual, the degree of turbulence is classified by use of seven atmospheric stability classes, designated A (extremely unstable) through G (extremely stable). The seven classes and some of their characteristics are listed in Table C-4 of Appendix C.

Meteorological conditions strongly impact the values of various parameters applied in the dose calculations of this manual. These include:

- The Relative Concentration Factor X/Q (Section 4.1.6)
- The Relative Deposition Factor D/Q (Section 4.1.7)

- The Gamma Air Dose Factor (Section 4.2.1)
- The Whole Body Dose Factor (Section 4.2.3)

Some bases sections of both the Standard Radiological Effluent Technical Specifications (guidance document) and the RETS specify that dose calculations be based on "historical average atmospheric conditions". Therefore, this manual provides values for the above parameters that are based on station-specific historical average meteorological conditions. These values were obtained by averaging hourly values of the parameters over a long-term, several-year, period of record. The averaging period was based on calendar years in order to avoid any bias from weather conditions associated with any one season. The period of record is identified in each of the tables providing the values (see Appendix F).

4.1.6 Relative Concentration Factor X/Q

A person immersed in a plume of airborne radioactivity is exposed to radiation from the plume and may also inhale some of the radioactivity from the plume. The concentration of radioactivity in air near the exposed person must be calculated to adequately evaluate doses resulting from any inhalation. The relative concentration factor X/Q (referred to as "chi over Q") is used to simplify these calculations. X/Q is the concentration of radioactivity in air, at a specified location, divided by the radioactivity release rate. X/Q has the following units:

$$\text{Units of X/Q} = (\mu\text{Ci}/\text{m}^3) / (\mu\text{Ci}/\text{sec}) = \text{sec}/\text{m}^3$$

Station-specific values of X/Q are provided for each nuclear power station in Table F-5 of Appendix F. These values are based on historical average atmospheric conditions (see Section 4.1.5). For each of the release point classifications (eg. stack, vent and ground level) and for the 16 compass-direction sectors (N, NNE, etc.), Table F-5 provides the maximum value of X/Q for locations at or beyond the unrestricted area boundary.

The value of X/Q for each sector reflects the fraction of time that the wind blew into that sector and the distribution of wind speeds and atmospheric stability classes during that time. Note that the value would be zero if the wind never blew into the sector.

The methodology for determining X/Q is discussed in detail in Section B.3 of Appendix B.

4.1.7 Relative Deposition Factor D/Q

As a plume travels away from its release point, portions of the plume may touch the ground and deposit radioactivity on the ground and/or on vegetation. Occurrences of such deposition are important to model since any radioactivity deposited on the ground or on vegetation may directly expose people and/or may be absorbed into food products which can ultimately be ingested by people. The relative deposition factor is used to simplify the dose calculations for these pathways.

The relative deposition factor D/Q is the rate of deposition of radioactivity on the ground divided by the radioactivity release rate. Its value was determined for specific conditions. In this manual it has the following units:

$$\text{Units of D/Q} = [(\text{pCi}/\text{sec})/\text{m}^2] / (\text{pCi}/\text{sec}) = 1/\text{m}^2$$

The values of D/Q are affected by the same parameters that affect the values of X/Q: release characteristics; meteorological conditions and location (see Section 4.1.6). Station-specific values of D/Q are provided for each ComEd nuclear power station in Appendix F Tables F-5 and F-6. These values are based on historical average atmospheric conditions (see Section 4.1.5).

For each release point classification and for each of the 16 compass-direction sectors (N, NNE, etc.), Table F-5 provides the maximum value of D/Q for locations at or beyond the unrestricted area boundary. In Table F-6, values of D/Q are given for the locations of the nearest milk and meat producers within 5 miles of the nuclear power station. The methodology for determining D/Q is discussed in Section B.4 of Appendix B.

4.1.8 Dose Factors

Various dose factors are used in this manual to simplify the calculation of radiation doses. These factors are listed in Table 4-2. Definitions of these factors are given in the remainder of this chapter. Methods of determining their values are addressed in Appendix B.

4.2 AIRBORNE RELEASES

4.2.1 Gamma Air Dose

The term 'gamma air dose' refers to the component of dose absorbed by air resulting from the absorption of energy from photons emitted during nuclear and atomic transformations, including gamma rays, x-rays, annihilation radiation, and Bremsstrahlung radiation (see footnote on page 1.109-19 of Regulatory Guide 1.109).

The Gamma Air Dose Factor

The gamma air dose factor is the gamma air dose rate divided by the radioactivity release rate. The value of the gamma air dose factor is determined by calculating the gamma dose rate to air (at a specific location and corresponding to a given release rate) and dividing that dose rate by the corresponding release rate:

$$\text{Gamma Air Dose Factor} = \frac{(\text{mrad/yr})}{(\mu\text{Ci/sec})}$$

The methodology for this calculation is discussed in Section B.5 of Appendix B. The calculation is complex because the dose rate at any given point is affected by the radioactivity concentration and distance. The value of the gamma air dose factor is also affected by all of the parameters that affect X/Q: release characteristics, meteorological conditions and location (see Section 4.1.6). Additionally, the value is affected by radiological parameters: the distribution of energies and intensities for gamma emissions from each specific radionuclide and the photon attenuation characteristics of air.

In the ODCM, station-specific values of gamma dose factors are provided for each station in Appendix F, Table F-7. These values are based on historical average atmospheric conditions (see Section 4.1.5). For the release point classification and for each of the 16 compass-direction sectors, Table F-7 provides the maximum value of the gamma air dose factor for noble gas radionuclides at the unrestricted area boundary. The value includes a correction for radioactive decay during transport of the radionuclide from the release point to the dose calculation location.

4.2.2 Beta Air Dose

The term 'beta air dose' refers to the component of dose to air dose resulting from the absorption of energy from emissions of beta particles, mono-energetic electrons and positrons during nuclear and atomic transformations (see the footnote on Page 1.109-20 of Regulatory Guide 1.109).

The Beta Air Dose Factor

The beta air dose factor is the beta air dose rate divided by the concentration of radioactivity in air at the dose calculation location. Values of the beta air dose factor are different for each radionuclide because of the differences in electron-emission spectra. Values for the beta air dose factors of 15 noble gas radionuclides are provided in Appendix C Table C-9.

The values of beta air dose factors are independent of nuclear power station because the size of a plume, at or beyond the restricted area boundary, is large compared to the range of the beta particle radiation. Therefore, the radioactivity concentration can be assumed to be constant over the entire volume surrounding a given beta dose calculation point. One can then define the beta air dose factor as the beta dose rate per unit of air radioactivity concentration. This relationship is independent of station-specific parameters. In contrast to this, the gamma air dose may depend on radioactivity concentration hundreds of feet away from the dose calculation point (see Section 4.2.1). Therefore, when determining the value of the gamma air dose factor, the shape of the plume over a large region must be considered. Plume shape does depend on station-specific parameters such as meteorology and release point classification and therefore values of the gamma air dose factor are station-specific.

4.2.3 Whole Body Dose and Dose Rate

Whole Body Dose

Equation A-6 of Appendix A is used to calculate dose to the whole body from noble gas radionuclides released in gaseous effluents. The deep dose equivalent (DDE) (or whole body dose) equation is similar to that used to calculate gamma air dose (Equation A-1 of Appendix A).

Whole Body Dose Rate

Equation A-8 of Appendix A is used to calculate dose rate to the whole body. The assumptions used for this equation are the same as those used in the calculation of whole body dose (Equation A-6 of Appendix A) except that any shielding benefit (dose attenuation) provided by residential structures is not applied. Since the calculation is for the maximum instantaneous dose rate, the dose recipient may be out of doors when exposed and would not be shielded from the exposure by any structural material.

The Whole Body Dose Factor

The whole body dose factor is the whole body dose rate divided by the radioactive release rate. Values for the whole body dose factor depend on the same parameters as those that affect the gamma air dose factor (see Section 4.2.1). The whole body dose factor is a 10CFR50 term that yields a Deep Dose Equivalent when applied to the radioactive release rate.

Station-specific values for the whole body dose factor are provided for each ComEd nuclear power station in Appendix F, Table F-7. These values are based on historical average atmospheric conditions (see Section 4.1.5). For each of 15 noble gas radionuclides, for the release point classifications, and for each of the 16 compass-direction sectors, Table F-7 provides the maximum value of the whole body dose factor at the unrestricted area boundary. These values include a correction for radioactive decay during transport of the radionuclide from the release point to the dose calculation location.

The methodology for determining whole body dose factors is addressed in Section B.6 of Appendix B.

4.2.4 Skin Dose and Dose Rate

Skin Dose

Equation A-7 of Appendix A is used to calculate dose to skin from noble gas radionuclides released in gaseous effluents. The skin dose is also referred to as the 'shallow dose equivalent' (SDE). The SDE is the summation of dose to the skin from beta and gamma radiation.

The equation for beta dose to skin is similar to that used to calculate beta dose to air (Equation A-2 of Appendix A) except that beta skin dose factors are used instead of beta air dose factors. The beta skin dose factor differs from the beta air dose factor by accounting for the attenuation of beta radiation by the dead layer of skin. The dead layer of skin is not susceptible to radiation damage and therefore is not of concern. The beta dose to the skin from non-noble gases is insignificant and is not calculated for the reason described in Section 4.1.3. When calculating the beta contribution to skin dose, no reduction is included in the calculations due to shielding provided by occupancy of residential structures.

The equation for gamma dose to skin is similar to that used to calculate gamma dose to air except for the following:

- Equation A-7 of Appendix A includes a units conversion factor 1.11 rem/rad to convert from units of gamma air dose (rad) to units of tissue dose equivalent (rem).
- Equation A-7 of Appendix A includes a dimensionless factor of 0.7 to account for the shielding due to occupancy of residential structures.

Equation A-7 of Appendix A uses gamma air dose factors not gamma whole body dose factors. When calculating gamma dose to skin, no reduction is applied for the attenuation of radiation due to passage through body tissue (dead layer of skin).

Skin Dose Rate

Equation A-9 of Appendix A is used to calculate dose rate to skin. The assumptions are the same as those used in the calculation of skin dose (Equation A-7 of Appendix A) except that no credit is taken for shielding of gamma radiation by residential structures. The dose recipient may be outdoors when exposed and the maximum instantaneous dose rate is of concern.

The Skin Dose Factor

As with the beta air dose factor, values of the beta skin dose factors are different for different radionuclides but do not vary from station to station. Values of the beta air dose factors and skin dose factors are provided in Table C-9 of Appendix C for 15 noble gas radionuclides.

4.2.5 Ground Radiation

Equations A-14 through A-16 of Appendix A are used to calculate the deep dose equivalent (whole body dose) due to non-noble gas radionuclides released in gaseous effluents and deposited on the ground.

Comment

Note that if there is no release of radionuclide 'i' during a given time period, then the deposition rate is zero, the ground plane concentration is zero and the resulting dose due to ground deposition is zero. If there is a release of radionuclide 'i', the ground concentration is computed as if that release had been occurring at a constant rate for the ground deposition time period.

The Ground Plane Dose Conversion Factor

The ground plane dose conversion factor is the dose rate to the whole body per unit of radioactivity concentration on the ground. Values of the ground plane dose conversion factor that are calculated by assuming constant concentration over an infinite plane are provided for various radionuclides in Table C-10 of Appendix C. The values are the same for all stations. The station-specific aspects of the calculation of ground dose concern the determination of the radioactivity concentration on the ground.

4.2.6 Inhalation

Dose Commitment

Radioactivity from airborne releases of radioactive iodine, particulate, tritium, and carbon-14 can enter the body through inhalation. Equation A-17 of Appendix A is used to calculate dose commitment to the whole body or its organs due to inhalation of non-noble gas radionuclides released in gaseous effluents. This dose component is also referred to as the 'committed dose equivalent' (CDE).

The Inhalation Dose Commitment Factor

Values for the inhalation dose commitment factor are the same for all ComEd stations. The components of this factor are not impacted by station specific parameters. However, the dose commitment factors used for compliance with 10CFR20 and 10CFR50 Appendix I are different as noted below:

- Values of the inhalation dose commitment factor used in the 10CFR50, Appendix I assessment are exactly those listed in Reg. Guide 1.109 (Reference 6) Tables E-7, 8, 9 and 10. These tables include data for four age groups (adult, teenager, child and infant) and seven body organs.
- Values of the inhalation dose commitment factor used for determining 10CFR20 and 40CFR190 compliance are exactly those listed in Table 2.1 of Federal Guidance Report No. 11 (FGR-11) (Reference 93). These data are for an adult and are given for all significant organs.

Dose Commitment Rate

The inhalation dose commitment rate is the rate at which dose commitment is accrued by an individual breathing contaminated air. Equation A-28 of Appendix A is used to calculate dose commitment rate to an organ due to inhalation of non-noble gas radionuclides. The assumptions are the same as used in the calculation of inhalation dose commitment (Equation A-17 of Appendix A).

4.2.7 Ingestion

Airborne releases of radioactive iodine, particulate, tritium, and carbon-14 can enter the food chain through deposition on, or absorption by, vegetation. The radioactivity can be ingested by humans who consume the vegetation or who consume products (e.g., milk or meat) of animals who have fed on the contaminated vegetation. Each ComEd nuclear power station considers the following four ingestion pathways:

- Leafy vegetables,
- Produce (e.g. non-leafy vegetables, fruit, and grain),
- Milk, and
- Meat.

Equation A-18 of Appendix A is used to calculate the dose commitment due to ingestion of food containing non-noble gas radionuclides released in gaseous effluents.

Values of the ingestion dose commitment factor are the same for each ComEd nuclear power station. The components of this factor are not impacted by station specific parameters. The station-specific aspects of the calculation of ingestion dose only concern the quantity of radioactivity ingested. However, the ingestion dose commitment factors used for 10CFR20 and for 10CFR50 compliance are different as was noted previously in section 4.2.6. These differences are noted below:

- Values of the ingestion dose commitment factor used in the 10CFR50 Appendix I assessment are exactly those listed in Reg. Guide 1.109 Tables E-11, 12, 13 and 14. These tables include data for four age groups and seven organs.
- Values of the ingestion dose commitment factor used in the 10CFR20 assessment are exactly those listed in Table 2.2 of Federal Guidance Report No. 11 (Reference 93). These tables include data for an adult and are given for all organs.

The ingested activity is calculated by use of equations A-19 through A-22 of Appendix A. The food product radioactivity concentration is calculated from measurements of radioactivity in station releases. The different equations used for radioactivity concentration in vegetation, milk, and meat are also discussed in Appendix A.

4.3 LIQUID RELEASES

The evaluation of dose and dose rate due to releases of radioactivity in liquid effluents is required to confirm compliance with the provisions of RETS related to 10CFR50 Appendix I. ODCM Section 3.2 and Figure 3-1 list some of the pathways by which radioactivity in liquid effluents can impact man. The principal pathways used by ComEd to calculate dose from liquid effluents are ingestion by drinking water and by eating fish from the body of water receiving station liquid discharges. The nuclear power stations obtain the dose commitment due to radioactivity in liquid effluent releases by summing the dose commitments from both the drinking water and fish pathways.

Equations A-29, A-30 and A-31 of Appendix A are used to calculate committed dose equivalent (CDE) for the member of the public due to consumption of drinking water and fish.

The radioactivity concentration in water is obtained by dividing the quantity of radioactivity released by the volume of water in which the release is diluted (e.g., the flow is multiplied by the total time of the release in hours). The result is multiplied by the following:

- A factor to represent any additional dilution that might occur.
- A factor to account for radioactive decay from the time of release to the time of consumption.

The radioactivity concentration in fish is the product of the radioactivity concentration in water and a bio-accumulation factor. The dilution and radioactive decay factors for fish may be different from those for water. (The fish may be caught at a location different from where drinking water is drawn and the time period from the release of radioactivity to consumption may be different.)

The bio-accumulation factor accounts for the fact that the quantity of radioactivity in fish can build up with time to a higher value relative to the concentration of the radioactivity in the water they consume. The bio-accumulation factor is the equilibrium ratio of the concentration of radionuclide 'i' in fish to its concentration in water. The same values are used for the bio-accumulation factor at each station. These values are provided in Appendix C, Table C-8.

4.4 CONTAINED SOURCES OF RADIOACTIVITY

In addition to the whole body, skin and single organ dose assessments previously described, an additional assessment is required. The additional assessment addresses radiation dose due to radioactivity contained within the nuclear power station and its structures.

There are presently two types of contained sources of radioactivity which are of concern in offsite radiological dose assessments. The first is that due to gamma rays resulting from nitrogen-16 carry-over to the turbine in BWR steam (skyshine). The second is that due to gamma rays associated with radioactive material contained in onsite radwaste and rad material storage facilities.

4.4.1 BWR Skyshine

The most significant dose component to members of the public produced by "contained sources" is nitrogen-16 (N-16) within the turbine building of BWRs. Although primary side shielding is around the turbine and its piping, N-16 gamma rays scattered by air molecules in the overhead air space above the turbine and piping cause a measurable "skyshine" radiation dose in the local power plant environs.

Equation A-34 of Appendix A is used to evaluate skyshine dose. A complicating factor in the calculation is the practice at some stations of adding hydrogen to reactor coolant to improve coolant chemistry. The addition of hydrogen can increase the dose rate due to skyshine up to a factor of 10 times expected levels depending on injection rates and power levels (Reference 39). Increasing the hydrogen injection rate will increase the dose rates even further. (See Reference 102) The skyshine dose determined by Equation A-34 of Appendix A depends on the following factors:

- The distance of the dose recipient location from the turbine.
- The number of hours per year that the location is occupied by a dose recipient.
- The total energy [MWe-hr] generated by the nuclear power station with hydrogen addition.
- The total energy [MWe-hr] generated by the nuclear power station without hydrogen addition.

4.4.2 Onsite Radwaste and Rad Material Storage Facilities

Low level radioactive waste may be stored at any ComEd nuclear power station in the following types of storage facilities:

- Process Waste Storage Facilities
 - Interim Radwaste Storage Facility (IRSF) structure
 - Concrete vaults containing 48 radwaste liners (Also referred to as "48-pack";)
- DAW Storage Facilities
 - Dry Active Waste (DAW) facilities (may include Butler buildings/warehouses)
- Replaced Steam Generator Storage Facilities

In addition, Rad Material may be stored in facilities on site:

- Rad Material Storage Facilities
 - Contaminated tools and equipment in seavans and/or warehouses

Administrative controls are implemented by each station to ensure compliance to applicable regulations. The impact to the offsite dose will be evaluated on a case by case basis and added to the station annex of the ODCM when applicable. In addition, a 10CFR50.59 analysis may be required for radwaste storage facilities.

4.5 TOTAL DOSE REQUIREMENTS

4.5.1 Total Effective Dose Equivalent Limits; 10CFR20 and 40CFR190

10CFR20 requires compliance to dose limits expressed as "Total Effective Dose Equivalent" (TEDE). The TEDE is the sum total of the external dose and the sum of the weighted internal doses. (See Appendix A; Sections A.4.3 and A.5.1)

4.5.2 Total Dose For Uranium Fuel Cycle

The nuclear power stations are required to determine the total dose to a member of the public due to all uranium fuel cycle sources in order to assess compliance with 40CFR190 as part of demonstrating compliance with 10CFR20.

The total dose for the uranium fuel cycle is the sum of doses due to radioactivity in airborne and liquid effluents and the doses due to direct radiation from contained sources at the nuclear power station. When evaluation of total dose is required for a station, the following contributions are summed:

- Doses due to airborne and liquid effluents from the station.
- Doses due to liquid effluents from nuclear power stations upstream.
- Doses due to nitrogen-16 (N^{16}) skyshine, if the station is a boiling water reactor.
- Doses due to any onsite radioactive waste storage facilities; if applicable.

Section A.5.2 of Appendix A discusses the details of evaluations.

Table 4-1

Radionuclide Types Considered For Airborne Effluent Exposure Pathways

| <u>Category</u> | <u>External Radiation</u> | | <u>Internal Radiation</u> | |
|-------------------------------|---------------------------|---------------|---------------------------|------------------|
| | <u>Plume</u> | <u>Ground</u> | <u>Inhalation</u> | <u>Ingestion</u> |
| Noble Gases | X | | | |
| Tritium (H-3) | | | X | X |
| Carbon-14 (C-14) ^a | | X | X | |
| Iodine ^b | | X | X | X |
| Particulate ^b | | X | X | X |

^a ComEd stations are not required to calculate dose due to C¹⁴. (See ODCM Bases and Reference document, Reference 101; Section O.4.5)

^b The nuclear power stations are not required to consider all iodine and particulate radionuclides. For details, see Generic Letter 89-01 and the RETS.

Table 4-2
Radiation Dose Factors

| <u>Name and Symbol</u> | <u>Units</u> | <u>Definition</u> | <u>Table</u> |
|--|---|--|--|
| Gamma Air Dose Factor S_i, V_i, G_i | mrad/yr per $\mu\text{Ci}/\text{sec}$ | Gamma air dose rate per unit of radioactivity release rate for radionuclide i for a stack (S_i), vent (V_i), or ground level (G_i) release. | F-7 F-7a |
| Whole Body Dose Factor: $\bar{S}_i, \bar{V}_i, \bar{G}_i$ | mrad/yr per $\mu\text{Ci}/\text{sec}$ | Whole body dose rate per unit of radioactivity release rate for radionuclide i for a stack (\bar{S}_i), vent (\bar{V}_i), or ground (\bar{G}_i) level release. | F-7 F-7a |
| Beta Air Dose Factor L_i | mrad/yr per $\mu\text{Ci}/\text{m}^3$ | Beta air dose rate per unit of radioactivity concentration for radionuclide i . | C-9 |
| Beta Skin Dose Factor \bar{L}_i | mrem/yr per $\mu\text{Ci}/\text{m}^3$ | Beta skin dose rate per unit of radioactivity concentration for radionuclide i . | C-9 |
| Ground Plane Dose Dose Conversion DFG_i | mrem/hr per pCi/m^2 | Dose rate per unit of ground radioactivity concentration for radionuclide i . | C-10 |
| Inhalation Dose Commitment Factor DFA_{ija} | mrem per pCi | Dose commitment to organ j of age group 'a' per unit of radioactivity inhaled for radionuclide i . (see Note 1) | RG 1.109 Tables; E-7, E-8, E-9, E-10 |
| Ingestion Dose Commitment Factor DFI_{ija} | mrem per pCi | Dose commitment to organ j of age group a per unit of radioactivity ingested for radionuclide i . (see Note 1) | RG 1.109 Tables; E-11, E-12, E-13, E-14 |
| Inhalation Dose Commitment Factor DFA_{ija} | Sv/Bq | Dose commitment to organ j of age group a per unit of radioactivity inhaled for radionuclide i (see Note 1). | FGR-11 Table 2.1 |
| Ingestion Dose Commitment Factor DFI_{ija} | Sv/Bq | Dose commitment to organ j of age group a per unit of radioactivity ingested for radionuclide i (see Note 1). | FGR-11 Table 2.2 |

Table 4-2

Radiation Dose Factors (cont.)

Note 1:

Dose assessments for 10CFR20 and 40CFR 190 compliance are made for an adult only using the dose commitment factors of Federal Guidance Report 11 (Reference 93). These are given in units of Sieverts per Becquerel. To convert these data to the conventional units of (mrem/pCi) the data must be multiplied by 3.7×10^3 .

Dose assessments for 10CFR50 Appendix I are made using dose factors of Regulatory Guide 1.109 (Reference 6) for all age groups.

CHAPTER 5

MEASUREMENT

5.0 INTRODUCTION

Each nuclear station has three measurement programs associated with offsite dose assessment:

- Measurement of releases of radioactivity from the station.
- Measurement of meteorology at the station site.
- Measurement of levels of radiation and radioactivity in the environs surrounding the station.

5.1 EFFLUENT AND PROCESS MONITORING

Radioactivity in liquid and gaseous effluents is measured in order to provide data for calculating radiation doses and radioactivity concentrations in the environment of each nuclear power station. Measurement of effluent radioactivity is required by 10CFR20.1302 and 10CFR50. The RETS of each nuclear power station provide detailed requirements for instrumentation, sampling and analysis. Relevant Regulatory Guides are 1.21 (Reference 4) and 4.15 (Reference 13). Chapter 10 of the ODCM includes brief descriptions of effluent monitoring instruments at each nuclear power station. The RETS of each nuclear power station require submission to the NRC of reports of effluent radioactivity releases and environmental measurements.

5.2 METEOROLOGICAL MONITORING

Meteorological parameters are measured in the vicinity of each nuclear power station in order to provide data for calculating radiation doses due to airborne effluent radioactivity. Some nuclear power station's Technical Specifications state applicable requirements (typically under the subheading, "Meteorological Instrumentation," in the instrumentation section). Regulatory guidance is given in Regulatory Guide 1.23 (Reference 5). Wind speed, wind direction and the temperature gradient are measured using instruments at two or more elevations on a meteorological tower at each ComEd station. The elevations are chosen to provide meteorological data representative of the elevations of the airborne releases from the station. The Annual Radiological Environmental Operating Report includes a summary of meteorological data collected over the reporting year. These data are used to calculate optional isopleths of radiation dose and radioactivity concentration.

5.3 RADIOLOGICAL ENVIRONMENTAL MONITORING PROGRAM (REMP)

Each nuclear power station has a REMP that provides representative measurements of radiation and radioactive material in the environment. The program provides verification that measurable radiological impacts from the power station on the environment are within expectations derived from effluent measurements and calculations. The REMP is required by 10CFR50 (see Appendix I, Sections IV.B.2 and IV.B.3). General requirements of the program are prescribed in each station's RETS and more precise details (such as specific monitoring locations) are specified in ODCM Chapter 11.

5.3.1 Interlaboratory Comparison Program

The laboratory which performs the REMP analyses is required by the RETS to participate in an interlaboratory comparison program. The purpose is to provide an independent check on the laboratory's analytical procedures and to alert it to potential problems (e.g. accuracy). In order to assess the measurements of radioactivity in environmental media, an independent agency supplies participating laboratories with samples of environmental media containing unspecified amounts of radioactivity. The laboratories measure the radioactivity concentrations and report the results to the agency. At a later time, the agency informs the participating laboratories of the actual concentrations and associated

uncertainties. Any significant discrepancies are investigated by the participating laboratories. A similar process is used to assess measurements of environmental radiation by passive thermoluminescent dosimeters.

CHAPTER 6

IMPLEMENTATION OF OFFSITE DOSE ASSESSMENT PROGRAM

6.1 NUCLEAR POWER STATION

The nuclear power station staff is responsible for effluent monitoring. The staff determines effluent radioactivity concentration and flow rate. This data is used to determine the radioactivity release information required for the Radioactive Effluent Release Report and to perform monthly calculations and projections of offsite radiation dose.

The nuclear power station staff is also responsible for control of effluent radioactivity. Procedures are implemented for determining, calculating and implementing setpoints. Liquid and gaseous radwaste treatment systems and ventilation exhaust treatment systems are utilized when appropriate. The nuclear power station staff implements the Process Control Program (PCP) for solid radwaste and measures tank radioactivity and BWR off-gas radioactivity.

The nuclear power station staff maintains instrumentation associated with these activities and demonstrates operability of the instrumentation in accordance with the surveillance requirements of the RETS. In the event that any RETS requirements are violated, the nuclear power station staff is responsible for taking one of the actions allowed by the RETS and issuing any required reports to the NRC.

The nuclear power station staff assembles and distributes the Radioactive Effluent Release Report.

The nuclear power station staff and/or the Generation Support Radiation Protection Department (GSRPD) reviews the Annual Radiological Environmental Operating Report prepared by the REMP contractor. The nuclear power station staff distributes the report to the NRC.

6.2 METEOROLOGICAL CONTRACTOR

The meteorological contractor operates and maintains the meteorological tower instrumentation at each nuclear power station. The contractor collects and analyzes the data and issues periodic reports. The contractor prepares the meteorological data summary required for the Annual Radiological Environmental Operating Report (AREOR) and also computes and plots isopleths included in the AREOR.

6.3 REMP CONTRACTOR

The radiological environmental contractor collects environmental samples and performs radiological analyses as specified in the nuclear power station's REMP (see ODCM Chapters 11 and 12). The contractor issues reports of results to GSRPD and each nuclear station. The contractor participates in an interlaboratory comparison program and reports results in the Annual Radiological Environmental Operating Report. The contractor performs the annual land use census and assembles the Annual Radiological Environmental Operating Report.

6.4 CORPORATE DEPARTMENTS

The Generation Support Radiation Protection Department (GSRPD) administers the offsite dose assessment computer program. The department maintains the generic section of the ODCM. The department oversees the meteorological and REMP contractors through administration of the purchase orders and by receiving and reviewing periodic reports.

A computer support group develops and maintains the computer program used by the nuclear power stations for offsite dose calculation and projection. GSRPD performs validation and verification of the computer code

CHAPTER 7

REFERENCES

1. Deleted
2. U.S. Nuclear Regulatory Commission, Standard Radiological Effluent Technical Specifications for Pressurized Water Reactors, NUREG-0472, Rev. 3, Draft, January 1983 (frequently revised).
3. U.S. Nuclear Regulatory Commission, Standard Radiological Effluent Technical Specifications for Boiling Water Reactors, NUREG-0473, Rev. 3, Draft, September 1982 (frequently revised).
4. U.S. Nuclear Regulatory Commission, Measuring, Evaluating, and Reporting Radioactivity in Solid Wastes and Releases of Radioactive Materials in Liquid and Gaseous Effluents from Light-Water-Cooled Nuclear Power Plants, Regulatory Guide 1.21. Revision 1, June 1974.
5. U.S. Nuclear Regulatory Commission, Onsite Meteorological Programs, Regulatory Guide 1.23, Safety Guide 23, February 17, 1972.
6. U.S. Nuclear Regulatory Commission, Calculation of Annual Doses to Man from Routine Releases of Reactor Effluents for the Purpose of Evaluating Compliance with 10 CFR Part 50 Appendix I, Regulatory Guide 1.109, Rev. 1, October 1977.
7. U.S. Nuclear Regulatory Commission, Methods for Estimating Atmospheric Transport and Dispersion of Gaseous Effluents in Routine Releases from Light-Water-Cooled Reactors, Regulatory Guide 1.111, Rev. 1, July 1977.
8. U.S. Nuclear Regulatory Commission, Calculation of Releases of Radioactive Materials in Gaseous and Liquid Effluents from Light-Water-Cooled Power Reactors, Regulatory Guide 1.112, Rev. 0-R, April 1976; reissued May 1977.
9. U.S. Nuclear Regulatory Commission, Estimating Aquatic Dispersion of Effluents from Accidental and Routine Reactor Releases for the Purpose of Implementing Appendix I, Regulatory Guide 1.113, Rev. 1, April 1977.
10. U.S. Nuclear Regulatory Commission, Programs for Monitoring Radioactivity in the Environs of Nuclear Power Plants, Regulatory Guide 4.1, Rev. 1, April 1975.
11. U.S. Nuclear Regulatory Commission, Preparation of Environmental Reports for Nuclear Power Stations, Regulatory Guide 4.2, Rev. 2, July 1976.
12. U.S. Nuclear Regulatory Commission, Environmental Technical Specifications for Nuclear Power Plants, Regulatory Guide 4.8, Rev. 1, December 1975. (See also the related Radiological Assessment Branch Technical Position, Rev. 1, November 1979.)
13. U.S. Nuclear Regulatory Commission, Quality Assurance for Radiological Monitoring Programs (Normal Operations)--Effluent Streams and the Environment, Regulatory Guide 4.15, Rev. 1, February 1979.
14. U.S. Nuclear Regulatory Commission, Preparation of Radiological Effluent Technical Specifications for Nuclear Power Plants, edited by J. S. Boegli et al. NUREG-0133, October 1978.

15. U.S. Nuclear Regulatory Commission, XOQDOQ: Computer Program for the Meteorological Evaluation of Routine Effluent Releases at Nuclear Power Stations, J. F. Sagendorf et al. NUREG/CR-2919, PNL-4380, September 1982.
16. U.S. Nuclear Regulatory Commission, Radiological Assessment, edited by J. E. Till and H. R. Meyer, NUREG/CR-3332, ORNL-5968, September 1983.
17. U.S. Nuclear Regulatory Commission, Standard Review Plan, NUREG-0800, July 1981.
18. U.S. Atomic Energy Commission, Meteorology and Atomic Energy 1968, edited by D. H. Slade, TID-21940, July 1968.
19. U.S. Atomic Energy Commission, Plume Rise, G. A. Briggs, TID-25075, 1969.
20. U.S. Atomic Energy Commission, The Potential Radiological Implications of Nuclear Facilities in the Upper Mississippi River Basin in the Year 2000, WASH 1209, January 1973.
21. U.S. Atomic Energy Commission, HASL Procedures Manual, Health and Safety Laboratory, HASL-300 (revised annually).
22. U.S. Department of Energy, Models and Parameters for Environmental Radiological Assessments, edited by C. W. Miller, DOE/TIC-11468, 1984.
23. U.S. Department of Energy, Atmospheric Science and Power Production, edited by D. Randerson, DOE/TIC-27601, 1984.
24. U.S. Environmental Protection Agency, Workbook of Atmospheric Dispersion Estimates, D. B. Turner, Office of Air Programs Publication No. AP-26, 1970.
25. U.S. Environmental Protection Agency, 40CFR190 Environmental Radiation Protection Requirements for Normal Operations of Activities in the Uranium Fuel Cycle, Final Environmental Statement, EPA 520/4-76-016, November 1, 1976.
26. U.S. Environmental Protection Agency, Environmental Analysis of the Uranium Fuel Cycle, EPA-520/9-73-003-C, November 1973.
27. American Society of Mechanical Engineers, Recommended Guide for the Prediction of the Dispersion of Airborne Effluents, 1973.
28. Eisenbud, M., Environmental Radioactivity, 3rd Edition, (Academic Press, Orlando, FL, 1987).
29. Glasstone, S., and Jordan, W. H., Nuclear Power and Its Environmental Effects (American Nuclear Society, LaGrange Park, IL, 1980).
30. International Atomic Energy Agency, Generic Models and Parameters for Assessing the Environmental Transfer of Radionuclides from Routine Releases, Safety Series, No. 57, 1982.
31. National Council on Radiation Protection and Measurements, Radiological Assessment: Predicting the Transport, Bioaccumulation, and Uptake by Man of Radionuclides Released to the Environment, NCRP Report No. 76, March 15, 1984.
32. American National Standards Institute, Guide to Sampling Airborne Radioactive Materials in Nuclear Facilities, ANSI N13.1-1969, February 19, 1969.

33. Institute of Electrical and Electronics Engineers, Specification and Performance of On-Site Instrumentation for Continuously Monitoring Radioactivity in Effluents, ANSI N13.10-1974, September 19, 1974.
34. American National Standards Institute, Testing and Procedural Specifications for Thermoluminescence Dosimetry (Environmental Applications), ANSI N545-1975, August 20, 1975.
35. American Nuclear Insurers, Effluent Monitoring, ANI/MAELU Engineering Inspection Criteria for Nuclear Liability Insurance, Section 5.1, Rev. 2, October 24, 1986.
36. American Nuclear Insurers, Environmental Monitoring, ANI/MAELU Engineering Inspection Criteria for Nuclear Liability Insurance, Section 5.2, Rev. 1, March 23, 1987.
37. American Nuclear Insurers, Environmental Monitoring Programs, ANI/MAELU Information Bulletin 86-1, June 9, 1986.
38. Cember, H., Introduction to Health Physics, 2nd Edition (Pergamon Press, Elmsford, NY 1983).
39. Electric Power Research Institute, Guidelines for Permanent BWR Hydrogen Water Chemistry Installations--1987 Revision, EPRI NP-5283-SR-A, Special Report, September 1987.
40. Commonwealth Edison Company, Information Relevant to Keeping Levels of Radioactivity in Effluents to Unrestricted Areas As Low As Reasonably Achievable, LaSalle County Station, Units 1 and 2, June 4, 1976.
41. U.S. Nuclear Regulatory Commission, Branch Technical Position, Radiological Assessment Branch, Revision 1, November 1979. (This is a branch position on Regulatory Guide 4.8.)
42. Deleted
43. U.S. Nuclear Regulatory Commission, Calculation of Releases of Radioactive Materials in Gaseous and Liquid Effluents from Pressurized Water Reactors (PWR-GALE Code), NUREG-0017, April 1976.
44. U.S. Nuclear Regulatory Commission, Calculation of Releases of Radioactive Materials in Gaseous and Liquid Effluents from Boiling Water Reactors (BWR-GALE Code), NUREG-0016, April 1976.
45. Sargent & Lundy, N-16 Skyshine from BWR Turbine Systems and Piping, NSLD Calculation No. D2-2-85, Rev. 0, 2/1/85.
46. Sargent & Lundy Calculation ATD-0138, Rev. 0, N-16 Skyshine Ground Level Dose from Dresden Turbine Systems and Piping, July 14, 1992.
47. Sargent & Lundy Calculation ATD-0139, Rev. 0, N-16 Skyshine Ground Level Dose from LaSalle Turbine Systems and Piping, July 28, 1992.
48. Sargent & Lundy Calculation ATD-0140, Rev. 0, N-16 Skyshine Ground Level Dose from Quad Cities Turbine Systems and Piping, July 28, 1992.
49. U.S. Nuclear Regulatory Commission, Methods for Demonstrating LWR Compliance with the EPA Uranium Fuel Cycle Standard (40 CFR Part 190), NUREG-0543, February 1980.

50. International Commission on Radiological Protection, Report of Committee Two on Permissible Dose for Internal Radiation, Recommendations of the International Commission on Radiological Protection, ICRP Publication 2, 1959.
51. U.S. Nuclear Regulatory Commission, Age-Specific Radiation Dose Commitment Factors for a One-Year Chronic Intake, Battelle Pacific Northwest Laboratories, NUREG-0172, 1977.
52. W. C. Ng, Transfer Coefficients for Prediction of the Dose to Man via the Forage-Cow-Milk Pathway from Radionuclides Released to the Biosphere, UCRL-51939.
53. E. C. Eimutis and M. G. Konicek, Derivations of Continuous Functions for the Lateral and Vertical Atmospheric Dispersion Coefficients, Atmospheric Environment 6, 859 (1972).
54. D. C. Kocher, Editor, Nuclear Decay Data for Radionuclides Occurring in Routine Releases from Nuclear Fuel Cycle Facilities, ORNL/NUREG/TM-102, August 1977.
55. R. L. Heath, Gamma-Ray Spectrum Catalog, Aerojet Nuclear Co., ANCR-1000-2, third or subsequent edition.
56. S. E. Thompson, Concentration Factors of Chemical Elements in Edible Aquatic Organisms, UCRL-50564, Rev. 1, 1972.
57. U.S. Nuclear Regulatory Commission, Instruction Concerning Risks from Occupational Radiation Exposure, Regulatory Guide 8.29, July 1981.
58. Dresden Nuclear Power Station, Radioactive Waste and Environmental Monitoring, Annual Report 1987, March 1988.
59. Reserved reference number
60. Sargent & Lundy Calculation ATD-0173, Rev. 0, 9/21/92, Annual Dose to Members of the Public Due to the LaSalle IRSF.
61. Sargent & Lundy Calculation ATD-0174, Rev. 0, 9/21/92, Annual Dose to Members of the Public Due to the Zion IRSF.
62. Sargent & Lundy Calculation ATD-0175, Rev. 0, 9/21/92, Annual Dose to Members of the Public Due to the Quad Cities IRSF.
63. Sargent & Lundy Calculation ATD-0176, Rev. 0, 9/21/92, Annual Dose to Members of the Public Due to the Dresden IRSF.
64. Reserved reference number
65. Sargent & Lundy Calculation ATD-0180, Rev. 0, 9/25/92, Dose Information Around Braidwood DAW Sea/Land Van Storage Area.
66. Sargent & Lundy Calculation ATD-0181, Rev. 0, 9/25/92, Dose Information Around Byron DAW Sea/Land Van Storage Area.
67. Sargent & Lundy Calculation ATD-0182, Rev. 0, 9/25/92, Dose Information Around Dresden DAW Sea/Land Van Storage Area.
68. Sargent & Lundy Calculation ATD-0183, Rev. 0, 9/25/92, Dose Information Around LaSalle DAW Sea/Land Van Storage Area.

69. Catalytic, Inc., Determination of Roof and Wall Shielding for Onsite and Offsite Radiation Protection from Skyshine, Calculation Index Number 70161-19, August 22, 1984 (applies to Dresden).
70. D. C. Kocher, Radioactivity Decay Data Tables, DOE/TIC-11026, 1981.
71. J. C. Courtney, A Handbook of Radiation Shielding Data, ANS/SD-76/14, July 1976.
72. Commonwealth Edison Company, Information Relevant to Keeping Levels of Radioactivity in Effluents to Unrestricted Areas As Low As Reasonably Achievable, Zion Station, Units 1 and 2, June 4, 1976.
73. Commonwealth Edison Company, Information Relevant to Keeping Levels of Radioactivity in Effluents to Unrestricted Areas As Low As Reasonably Achievable, Dresden Station, Units 2 and 3, June 4, 1976.
74. Commonwealth Edison Company, Information Relevant to Keeping Levels of Radioactivity in Effluents to Unrestricted Areas As Low As Reasonably Achievable, Quad Cities Station, Units 1 and 2, June 4, 1976.
75. Sargent & Lundy, METWRSUM, S&L Program Number 09.5.187-1.0.
76. Sargent & Lundy, Comments on CEC Co ODCM and List of S&L Calculations, Internal Office Memorandum, P. N. Derezotes to G. R. Davidson, November 23, 1988.
77. Sargent & Lundy, AZAP, A Computer Program to Calculate Annual Average Offsite Doses from Routine Releases of Radionuclides in Gaseous Effluents and Postaccident X/Q Values, S&L Program Number 09.8.054-1.7.
78. National Oceanic and Atmospheric Administration, A Program for Evaluating Atmospheric Dispersion from a Nuclear Power Station, J. F. Sagendorf, NOAA Technical Memorandum ERL ARL-42, Air Resources Laboratory, Idaho Falls, Idaho, May 1974.
79. G. P. Lahti, R. S. Hubner, and J. C. Golden, Assessment of Gamma-Ray Exposures Due to Finite Plumes, Health Physics 41, 319 (1981).
80. National Council of Radiation Protection and Measurements, Ionizing Radiation Exposure of the Population of the United States, NCRP Report No. 93, September 1, 1987.
81. Reserved reference number
82. W. R. Van Pelt (Environmental Analysts, Inc.), Letter to J. Golden (ComEd) dated January 3, 1972.
83. Electric Power Research Institute, Radiological Effects of Hydrogen Water Chemistry, EPRI NP-4011, May 1985.
84. U.S. Nuclear Regulatory Commission, Draft Generic Environmental Impact Statement on Uranium Milling, NUREG-0511, April 1979.
85. U.S. Environmental Protection Agency, Environmental Analysis of the Uranium Fuel Cycle, Part I - Fuel Supply, EPA-520/9-73-003-B, October 1973.

86. U.S. Nuclear Regulatory Commission, Final Generic Environmental Statement on the Use of Recycle Plutonium in Mixed Oxide Fuel in Light Water Cooled Reactors, NUREG-0002, August 1976.
87. U.S. Nuclear Regulatory Commission, Demographic Statistics Pertaining to Nuclear Power Reactor Sites, NUREG-0348, Draft, December 1977.
88. Nuclear News 31, Number 10, Page 69 (August 1988).
89. General Electric Company, Irradiated Fuel Storage at Morris Operation, Operating Experience Report, January 1972 through December 1982, K. J. Eger, NEDO-20969B.
90. U.S. Nuclear Regulatory Commission, Generic Letter 89-01, "Guidance For The Implementation of Programmatic Controls For RETS In The Administrative Controls Section of Technical Specifications and the Relocation of Procedural Details of Current RETS to the Offsite Dose Calculation Manual or Process Control Program", January 1989.
91. "Assessment of the Impact of Liquid Radioactive Effluents from Braidwood Station on Proposed Public Water Intakes at Wilmington, Illinois", J.C. Golden, NSEP, January 1990
92. NRC Safety Evaluation Report (SER)/Idaho Notional Engineering Laboratory Technical Evaluation Report (TER) of the Commonwealth Edison Offsite Dose Calculation Manual (ODCM), Revision O.A, December 2, 1991.
93. K. F. Eckerman, et al, Limiting Values of Radionuclide Intake and Air Concentration and Dose Conversions Factors for Inhalation, Submersion and Inhalation, Federal Guidance Report No. 11, U.S. Environmental Protection Agency Report EPA-520/1-88-020, September 1988.
94. Deleted.
95. U.S. Nuclear Regulatory Commission, Standards for Protection Against Radiation (10CFR20).
96. U.S. Nuclear Regulatory Commission, Licensing of Production and Utilization Facilities (10CFR50).
97. Federal Register, Vol. 57, No. 169, Monday, August 31, 1992, page 39358.
98. Miller, Charles W., Models and Parameters for Environmental Radiological Assessments, U.S. Dept. of Energy, DE8102754, 1984, pages 32, 33, 48, and 49.
99. Kocher, D. C., "Dose-Rate Conversion Factors For External Exposure To Photons and Electrons", Health Physics Vol. 45, No. 3 (September), pp. 665-686, 1983.
100. U.S. Department of Health, Education and Welfare Public Health Service, Radiological Health Handbook, January 1970.
101. ODCM Bases and Reference Document, rev.0, November, 1998.
102. G. Moran, D. Goff, Quad Cities Nuclear Power Station; 1993 Hydrogen Water Chemistry Stress Corrosion Monitoring Test - Unit 2, 9/17-23/93.
103. U.S. Nuclear Regulatory Commission, Generic Letter 79-041, September 17, 1979.

REFERENCES

1. Commonwealth Edison Company, Public Dose Models for Radiological Effluents Technical Standards (RETS) Compliance General Computer Program Instructions, CEPIP-1030-03.
2. U.S. Nuclear Regulatory Commission, Standard Radiological Effluent Technical Specifications for Pressurized Water Reactors, NUREG-0472, Rev. 3, Draft, January 1983 (frequently revised).
3. U.S. Nuclear Regulatory Commission, Standard Radiological Effluent Technical Specifications for Boiling Water Reactors, NUREG-0473, Rev. 3, Draft, September 1982 (frequently revised).
4. U.S. Nuclear Regulatory Commission, Measuring, Evaluating, and Reporting Radioactivity in Solid Wastes and Releases of Radioactive Materials in Liquid and Gaseous Effluents from Light-Water-Cooled Nuclear Power Plants. Regulatory Guide 1.21. Revision 1, June 1974.
5. U.S. Nuclear Regulatory Commission, Onsite Meteorological Programs, Regulatory Guide 1.23, Safety Guide 23, February 17, 1972.
6. U.S. Nuclear Regulatory Commission, Calculation of Annual Doses to Man from Routine Releases of Reactor Effluents for the Purpose of Evaluating Compliance with 10 CFR Part 50 Appendix I, Regulatory Guide 1.109, Rev. 1, October 1977.
7. U.S. Nuclear Regulatory Commission, Methods for Estimating Atmospheric Transport and Dispersion of Gaseous Effluents in Routine Releases from Light-Water-Cooled Reactors, Regulatory Guide 1.111, Rev. 1, July 1977.
8. U.S. Nuclear Regulatory Commission, Calculation of Releases of Radioactive Materials in Gaseous and Liquid Effluents from Light-Water-Cooled Power Reactors, Regulatory Guide 1.112, Rev. 0-R, April 1976; reissued May 1977.
9. U.S. Nuclear Regulatory Commission, Estimating Aquatic Dispersion of Effluents from Accidental and Routine Reactor Releases for the Purpose of Implementing Appendix I, Regulatory Guide 1.113, Rev. 1, April 1977.
10. U.S. Nuclear Regulatory Commission, Programs for Monitoring Radioactivity in the Environs of Nuclear Power Plants, Regulatory Guide 4.1, Rev. 1, April 1975.
11. U.S. Nuclear Regulatory Commission, Preparation of Environmental Reports for Nuclear Power Stations, Regulatory Guide 4.2, Rev. 2, July 1976.
12. U.S. Nuclear Regulatory Commission, Environmental Technical Specifications for Nuclear Power Plants, Regulatory Guide 4.8, Rev. 1, December 1975. (See also the related Radiological Assessment Branch Technical Position, Rev. 1, November 1979.)
13. U.S. Nuclear Regulatory Commission, Quality Assurance for Radiological Monitoring Programs (Normal Operations)--Effluent Streams and the Environment, Regulatory Guide 4.15, Rev. 1, February 1979.
14. U.S. Nuclear Regulatory Commission, Preparation of Radiological Effluent Technical Specifications for Nuclear Power Plants, edited by J. S. Boegli et al. NUREG-0133, October 1978.
15. U.S. Nuclear Regulatory Commission, XOQDOQ: Computer Program for the Meteorological Evaluation of Routine Effluent Releases at Nuclear Power Stations, J. F. Sagendorf et al.

September 19, 1974.

34. American National Standards Institute, Testing and Procedural Specifications for Thermoluminescence Dosimetry (Environmental Applications), ANSI N545-1975, August 20, 1975.
35. American Nuclear Insurers, Effluent Monitoring, ANI/MAELU Engineering Inspection Criteria for Nuclear Liability Insurance, Section 5.1, Rev. 2, October 24, 1986.
36. American Nuclear Insurers, Environmental Monitoring, ANI/MAELU Engineering Inspection Criteria for Nuclear Liability Insurance, Section 5.2, Rev. 1, March 23, 1987.
37. American Nuclear Insurers, Environmental Monitoring Programs, ANI/MAELU Information Bulletin 86-1, June 9, 1986.
38. Cember, H., Introduction to Health Physics, 2nd Edition (Pergamon Press, Elmsford, NY 1983).
39. Electric Power Research Institute, Guidelines for Permanent BWR Hydrogen Water Chemistry Installations--1987 Revision, EPRI NP-5283-SR-A, Special Report, September 1987.
40. Commonwealth Edison Company, Information Relevant to Keeping Levels of Radioactivity in Effluents to Unrestricted Areas As Low As Reasonably Achievable. LaSalle County Station, Units 1 and 2, June 4, 1976.
41. U.S. Nuclear Regulatory Commission, Branch Technical Position, Radiological Assessment Branch, Revision 1, November 1979. (This is a branch position on Regulatory Guide 4.8.)
42. Commonwealth Edison Company, Emergency Preparedness Review and Distribution of NRC Submittals: Semi-Annual Radioactive Effluent Release, and Annual Radiological Environmental Operating Reports, CEPIP-1030-01.
43. U.S. Nuclear Regulatory Commission, Calculation of Releases of Radioactive Materials in Gaseous and Liquid Effluents from Pressurized Water Reactors (PWR-GALE Code), NUREG-0017, April 1976.
44. U.S. Nuclear Regulatory Commission, Calculation of Releases of Radioactive Materials in Gaseous and Liquid Effluents from Boiling Water Reactors (BWR-GALE Code), NUREG-0016, April 1976.
45. Sargent & Lundy, N-16 Skyshine from BWR Turbine Systems and Piping, NSLD Calculation No. D2-2-85, Rev. 0, 2/1/85.
46. Sargent & Lundy Calculation ATD-0138, Rev. 0, N-16 Skyshine Ground Level Dose from Dresden Turbine Systems and Piping, July 14, 1992.
47. Sargent & Lundy Calculation ATD-0139, Rev. 0, N-16 Skyshine Ground Level Dose from LaSalle Turbine Systems and Piping, July 28, 1992.
48. Sargent & Lundy Calculation ATD-0140, Rev. 0, N-16 Skyshine Ground Level Dose from Quad Cities Turbine Systems and Piping, July 28, 1992.
49. U.S. Nuclear Regulatory Commission, Methods for Demonstrating LWR Compliance with the EPA Uranium Fuel Cycle Standard (40 CFR Part 190), NUREG-0543, February 1980.

DAW Sea/Land Van Storage Area.

69. Catalytic, Inc., Determination of Roof and Wall Shielding for Onsite and Offsite Radiation Protection from Skyshine, Calculation Index Number 70161-19, August 22, 1984 (applies to Dresden).
70. D. C. Kocher, Radioactivity Decay Data Tables, DOE/TIC-11026, 1981.
71. J. C. Courtney, A Handbook of Radiation Shielding Data, ANS/SD-76/14, July 1976.
72. Commonwealth Edison Company, Information Relevant to Keeping Levels of Radioactivity in Effluents to Unrestricted Areas As Low As Reasonably Achievable. Zion Station. Units 1 and 2, June 4, 1976.
73. Commonwealth Edison Company, Information Relevant to Keeping Levels of Radioactivity in Effluents to Unrestricted Areas As Low As Reasonably Achievable. Dresden Station. Units 2 and 3, June 4, 1976.
74. Commonwealth Edison Company, Information Relevant to Keeping Levels of Radioactivity in Effluents to Unrestricted Areas As Low As Reasonably Achievable. Quad Cities Station. Units 1 and 2, June 4, 1976.
75. Sargent & Lundy, METWRSUM, S&L Program Number 09.5.187-1.0.
76. Sargent & Lundy, Comments on CEC Co ODCM and List of S&L Calculations, Internal Office Memorandum, P. N. Derezotes to G. R. Davidson, November 23, 1988.
77. Sargent & Lundy, AZAP. A Computer Program to Calculate Annual Average Offsite Doses from Routine Releases of Radionuclides in Gaseous Effluents and Postaccident X/Q Values, S&L Program Number 09.8.054-1.7.
78. National Oceanic and Atmospheric Administration, A Program for Evaluating Atmospheric Dispersion from a Nuclear Power Station, J. F. Sagendorf, NOAA Technical Memorandum ERL ARL-42, Air Resources Laboratory, Idaho Falls, Idaho, May 1974.
79. G. P. Lahti, R. S. Hubner, and J. C. Golden, Assessment of Gamma-Ray Exposures Due to Finite Plumes, Health Physics 41, 319 (1981).
80. Reserved reference number
81. Reserved reference number
82. W. R. Van Pelt (Environmental Analysts, Inc.), Letter to J. Golden (CECo) dated January 3, 1972.
83. Electric Power Research Institute, Radiological Effects of Hydrogen Water Chemistry, EPRI NP-4011, May 1985.
84. U.S. Nuclear Regulatory Commission, Draft Generic Environmental Impact Statement on Uranium Milling, NUREG-0511, April 1979.
85. U.S. Environmental Protection Agency, Environmental Analysis of the Uranium Fuel Cycle. Part I - Fuel Supply, EPA-520/9-73-003-B, October 1973.

APPENDIX A

COMPLIANCE METHODOLOGY

TABLE OF CONTENTS

| | <u>PAGE</u> |
|--|-------------|
| A.0 INTRODUCTION | A-1 |
| A.1 AIRBORNE RELEASES | A-1 |
| 1. Release Point Classifications | A-1 |
| 2. Dose Due to Noble Gas Radionuclides | A-2 |
| 1. Gamma Air Dose | A-2 |
| 2. Beta Air Dose | A-3 |
| 3. Total Body Dose | A-4 |
| 4. Skin Dose | A-5 |
| 3. Dose Rate Due to Noble Gas Radionuclides | A-6 |
| 1. Whole Body Dose Rate | A-6 |
| 2. Skin Dose Rate | A-6 |
| 4. Dose Due to Non-Noble Gas Radionuclides | A-7 |
| 1. Ground Deposition | A-8 |
| 2. Inhalation | A-8 |
| 3. Food Pathways | A-10 |
| 1. Vegetation | A-11 |
| 2. Milk | A-12 |
| 3. Meat | A-15 |
| 5. Dose Rate Due to Non-Noble Gas Radionuclides | A-15 |
| 6. Operability and Use of Gaseous Effluent Treatment Systems | A-16 |
| A.2 LIQUID RELEASES | A-17 |
| 1. Dose | A-17 |
| 2. Liquid Effluent Concentrations Requirement | A-19 |
| 3. Tank Discharges | A-20 |
| 4. Tank Overflow | A-21 |
| 5. Operability and Use of the Liquid Radwaste Treatment System | A-21 |
| 6. Drinking Water | A-21 |
| 7. Non-routine Liquid Release Pathways | A-21 |
| A.3 DOSE DUE TO CONTAINED SOURCES | A-21 |
| 1. BWR Skyshine | A-22 |
| 2. Dose from Onsite Radwaste Storage Facilities | A-23 |
| A.4 TOTAL DOSE LIMITS | A-24 |
| 1. Deep Dose Equivalent | A-24 |
| 2. Committed Effective Dose Equivalent | A-24 |
| 3. Total Effective Dose Equivalent | A-25 |

APPENDIX A
TABLE OF CONTENTS (Cont'd)

| | <u>PAGE</u> |
|---|-------------|
| A.5 COMPLIANCE TO TOTAL DOSE LIMITS | A-26 |
| 1. Total Effective Dose Equivalent Limit - 10CFR20 Compliance | A-26 |
| 2. Total Dose Due to the Uranium Fuel Cycle (40CFR190) | A-26 |
| 3. Summary of Compliance Methodology | A-27 |
| A.6 DOSE DUE TO DRINKING WATER (40CFR141) | A-27 |
| 1. 40CFR141 Restrictions on Manmade Radionuclides | A-27 |
| 2. Application | A-28 |

LIST OF TABLES

| <u>NUMBER</u> | <u>TITLE</u> | <u>PAGE</u> |
|---------------|---|-------------|
| A-0 | Average Annual Concentrations Assumed to Produce a Total Body or Organ Dose of 4 mrem/yr. | A-28 |
| A-1 | Compliance Matrix | A-29 |
| A-2 | Release Point Classifications | A-30 |
| A-3 | Nearest Downstream Community Water Systems | A-31 |
| A-4 | 40CFR190 Compliance | A-32 |

APPENDIX A

COMPLIANCE METHODOLOGY

A.0 INTRODUCTION

This appendix reviews the offsite radiological limits applicable to the nuclear power stations and presents in detail the equations and procedures used to assess compliance with these limits. An introduction to the calculational approach used here is given in Chapter 4. The approach incorporates simplifications such as the following:

- Use of pre-calculated atmospheric transport parameters based on historical average atmospheric conditions (see Section 4.1.5). These factors, X/Q and D/Q , are defined in Chapter 4.
- Use of pre-calculated dose factors based on historical average atmospheric conditions. For example, a dose factor with units (mrad/yr) per ($\mu\text{Ci}/\text{sec}$) is used to obtain gamma dose rate in mrad/yr from noble gas release rate in $\mu\text{Ci}/\text{sec}$.

Values of these parameters are obtained as described in Appendix B.

The equations and parameters of this appendix are for use in calculating offsite radiation doses during routine operating conditions. They are not for use in calculating doses due to non-routine releases (e.g., accident releases).

The applicable radiation protection regulations included in 10CFR20, 10CFR50 Appendix I, and 40CFR190 each require a different type of radiological dose assessment. In some cases, e.g. ingestion and inhalation pathways, the calculations used to demonstrate compliance may be similar, but the reference dose conversion factors differ because of historical regulatory evolution. This section of the ODCM develops, in detail, the evaluation used to determine the individual components of the total dose, and then indicates which are reportable and in some cases combined to demonstrate regulatory compliance.

An overview of the required compliance is given in Tables 2-1, 2-2, and 2-3. In Table 2-1, the dose components are itemized and referenced, and an indication of their regulatory application is noted. A more detailed compliance matrix is given in Table 2-3. Additionally, the locations of dose receivers for each dose component are given in Table 2-2.

The following sections detail the required radiological dose calculations.

A.1 AIRBORNE RELEASES

A.1.1 Release Point Classifications

The pattern of dispersion of airborne releases is dependent on the height of the release point relative to adjacent structures. For the equations of this appendix, each release point is classified as one of the following three height-dependent types, which are defined in Section 4.1.4:

- Stack (or Elevated) Release Point (denoted by the letter S or subscript s)
- Ground Level Release Point (denoted by the letter G or subscript g)
- Vent (or Mixed Mode) Release Point (denoted by the letter V or subscript v)

The release point classifications of routine release points at the nuclear power stations are stated in Table A-2

A.1.2 Dose Due to Noble Gas Radionuclides

A.1.2.1 Gamma Air Dose

Requirement

RETS limit the gamma air dose due to noble gas effluents released from each reactor unit to areas at and beyond the unrestricted area boundary to the following:

- Less than or equal to 5 mrad per calendar quarter.
- Less than or equal to 10 mrad per calendar year.

Equation

The gamma air dose due to noble gases released in gaseous effluents is calculated by the following expression:

$$D_{\gamma} = (3.17E-8) \sum \{ S_i A_{is} + V_i A_{iv} + G_i A_{ig} \} \quad (A-1)$$

The summation is over noble gas radionuclides *i*.

| | | |
|--------------------------|---|-----------------------|
| D_{γ} | Gamma Air Dose Dose to air due to gamma radiation from noble gas radionuclides released in gaseous effluents. | [mrad] |
| 3.17E-8 | Conversion Constant (seconds to years) | [yr/sec] |
| S_i, V_i, G_i | Gamma Air Dose Factor Gamma air dose rate at a specified location per unit of radioactivity release rate for radionuclide 'i' released from a stack, vent, or ground level release point, respectively. See Section 4.2.1, Section B.5 of Appendix B, and Table F-7 of Appendix F. | [(mrad/yr)/(μCi/sec)] |
| A_{is}, A_{iv}, A_{ig} | Cumulative Radionuclide Release Measured cumulative release of radionuclide 'i' over the time period of interest from a stack, vent, or ground level release point. | [μCi] |

Application

RETS require determination of cumulative and projected gamma air dose contributions due to noble gases for the current calendar quarter and the current calendar year at least once per 31 days (see Sections 12.4 of each station's RETS or Technical Specifications).

The dose factors in Table F-7 of Appendix F are used for the determinations required by these specifications. These values were calculated for the unrestricted area boundary in each sector and are judged to be very good approximations to the maximum offsite values. After doses for all sectors are determined, the highest dose is compared with the RETS limit on gamma air dose.

For a release attributable to a processing or effluent system shared by more than one reactor unit, the dose due to an individual unit is obtained by proportioning the effluents among the units sharing the system. The allocation procedure is specified in ODCM Chapter 10.

A.1.2.2 Beta Air Dose

Requirement

RETS limit the beta air dose due to noble gases in gaseous effluents released from each reactor unit to areas at and beyond the unrestricted area boundary to the following:

- Less than or equal to 10 mrad per calendar quarter.
- Less than or equal to 20 mrad per calendar year.

Equation

The beta air dose due to noble gases released in gaseous effluents is calculated by the following expression

$$D_{\beta} = (3.17E-8)\sum\{ L_i[(X/Q)_s A'_{is} + (X/Q)_v A'_{iv} + (X/Q)_g A'_{ig}] \} \quad (A-2)$$

The summation is over noble gas radionuclides 'i'.

| | | |
|-------------------------------------|--|-----------------------------------|
| D_{β} | Beta Dose Dose to air due to beta radiation from noble gas radionuclides released in gaseous effluents. | [mrad] |
| 3.17E-8 | Conversion Constant (seconds to years) | [yr/sec] |
| L_i | Beta Air Dose Factor Beta air dose rate per unit of radioactivity concentration for radionuclide 'i'. See Section 4.2.2, Section B.7 of Appendix B, and Table C-9 of Appendix C. | [(mrad/yr)/(μCi/m ³)] |
| $(X/Q)_s$ $(X/Q)_v$ $(X/Q)_g$ | Relative Concentration Factor Radioactivity concentration at a specified location per unit of radioactivity release rate for a stack, vent, or ground level release. See Section 4.1.6, Section B.3 of Appendix B, and Table F-5 of Appendix F. | [sec/m ³] |
| A'_{is} A'_{iv} A'_{ig} | Cumulative Radionuclide Release, Adjusted for Radiodecay Measured cumulative release of radionuclide 'i' over the time period of interest from a stack, vent, or ground level release point, reduced to account for radiodecay in transit from the release point to the dose point: | [μCi] |
| | $A'_{is} = A_{is} \exp(-\lambda_i R/3600u_s)$ | (A-3) |
| | $A'_{iv} = A_{iv} \exp(-\lambda_i R/3600u_v)$ | (A-4) |
| | $A'_{ig} = A_{ig} \exp(-\lambda_i R/3600u_g)$ | (A-5) |
| A_{is} A_{iv} A_{ig} | Cumulative Radionuclide Release Defined in Section A.1.2.1. | [μCi] |
| λ_i | Radiological Decay Constant Radiological decay constant for radionuclide 'i'. See | [hr ⁻¹] |

Table C-7 of Appendix C.

| | | |
|----------------------|---|----------|
| R | Downwind Range Distance from the release point to the dose point. See Tables F-5, F-6, and F-7. | [m] |
| 3600 | Conversion Constant Converts hours to seconds. | [sec/hr] |
| u_s | Average Wind Speed | [m/sec] |
| u_v | | |
| u_g | Average wind speed for a stack, vent, or ground level release. See Section B.1.3 of Appendix B and Table F-4 of Appendix F. | |

Application

RETS require determination of cumulative and projected beta air dose contributions due to noble gases for the current calendar quarter and the current calendar year at least once per 31 days (see Section 12.4 of each station's RETS or Technical Specification).

Beta air dose is determined for each sector using the highest calculated offsite value of X/Q for that sector. This value and the distance **R** to which it pertains are provided in Table F-5 of Appendix F. The highest dose is compared with the limit on beta air dose.

For a release attributable to a processing or effluent system shared by more than one reactor unit, the dose due to an individual unit is obtained by proportioning the effluents among the units sharing the system. The allocation procedure is specified in ODCM Chapter 10.

A.1.2.3 Total Body Dose

Requirement

The whole body dose, also called the deep dose equivalent (DDE), to any receiver is due, in part, to gamma radiation emitted from radioactivity in airborne effluents. This component is added to others to demonstrate compliance to the requirements of 40CFR190 and 10CFR20.

Equation

The whole body dose/DDE component due to gamma radiation from noble gases released in gaseous effluents is calculated by the following expression:

$$D_{wb} = (0.7)(1.11)(3.17E-8) \times \sum \{ \bar{S}_i A_{is} + \bar{V}_i A_{iv} + \bar{G}_i A_{ig} \} \tag{A-6}$$

The summation is over noble gas radionuclides 'i'.

| | | |
|-----------------------|---|-------------|
| D_{wb} | Whole Body Dose [mrem] Dose to the whole body due to gamma radiation from noble gas radionuclides released in gaseous effluents. | |
| 0.7 | Shielding Factor; a dimensionless factor that accounts for shielding due to the occupancy of structures. | |
| 1.11 | Conversion Constant (rads in air to rem in tissue) | [mrem/mrad] |
| 3.17E-8 | Conversion Constant (seconds to years) | [yr/sec] |

| | | |
|-----------------------------------|--|---------------------------------|
| $\bar{S}_i, \bar{V}_i, \bar{G}_i$ | Gamma Whole Body Dose Factor | [(mrad/yr)/ (μ Ci/sec)] |
| | Gamma whole body dose rate at a specified location per unit of radioactivity release rate for radionuclide 'i' released from a stack, vent, or ground level release point. The attenuation of gamma radiation due to passage through 1 cm of body tissue of 1 g/cm ³ density is taken into account in calculating this quantity. See Section 4.2.3, Section B.6 of Appendix B, and Table F-7 of Appendix F. | |
| A_{is}, A_{iv}, A_{ig} | Cumulative Radionuclide Release | [μ Ci] |
| | Defined in Section A.1.2.1. | |

Application

The whole body dose (deep dose equivalent) is included in the 40CFR190 and 10CFR20 compliance assessments. In some cases, the whole body dose may be required in 10CFR50 Appendix I assessments (See Table 2-1).

A.1.2.4 Skin Dose

Requirement

There is no regulatory requirement to evaluate skin dose, also referred to as the shallow dose equivalent (SDE). However, this component is evaluated for reference as there is skin dose design objective contained in 10CFR50 Appendix I. Note that in the unlikely event that if beta air dose guideline is exceeded, then the skin dose will require evaluation.

Equation

The part of skin dose due to noble gases released in gaseous effluents is calculated by the following expression:

$$D_s = (3.17E-8) \sum \{ \bar{L}_i [(X/Q)_s A'_{is} + (X/Q)_v A'_{iv} + (X/Q)_g A'_{ig}] + (0.7)(1.11)[S_i A_{is} + V_i A_{iv} + G_i A_{ig}] \} \quad (A-7)$$

The summation is over noble gas radionuclides 'i'.

| | | |
|-------------|---|---|
| D_s | Skin Dose Dose to the skin due to beta and gamma radiation from noble gas radionuclides released in gaseous effluents. | [mrem] |
| \bar{L}_i | Beta Skin Dose Factor Beta skin dose rate per unit of radioactivity concentration for radionuclide 'i'. Attenuation of beta radiation passing through 7 mg/cm ² of dead skin is accounted for. See Section 4.2.4, Section B.7 of Appendix B, and Table C-9 of Appendix C. | [(mrem/yr)/ (μ Ci/m ³)] |

The remaining parameters are defined in Sections A.1.2.1 and A.1.2.2.

Application

The skin dose is calculated for reference only.

A.1.3 Dose Rate Due to Noble Gas Radionuclides

A.1.3.1 Whole Body Dose Rate

Requirement

RETS limit the whole body dose rate (deep dose equivalent rate) due to noble gases in gaseous effluents released from a site to areas at and beyond the site boundary to less than or equal to a dose rate of 500 mrem/yr at all times. (see Section 12.4 of each station's RETS and Technical Specifications)

Equation

The whole body dose rate (deep dose equivalent rate) due to noble gases released in gaseous effluents is calculated by the following expression:

$$\dot{D}_{wb} = (1.11) \sum \{ \bar{S}_i Q_{is} + \bar{V}_i Q_{iv} + \bar{G}_i Q_{ig} \} \quad (A-8)$$

The summation is over noble gas radionuclides 'i'.

\dot{D}_{wb} Whole Body Dose Rate [mrem/yr]
Dose rate to the whole body due to gamma radiation from noble gas radionuclides released in gaseous effluents.

Q_{is}, Q_{iv}, Q_{ig} Release Rate [μ Ci/sec]
Measured release rate of radionuclide 'i' from a stack, vent, or ground level release point.

The remaining parameters have the same definitions as used in the equation for whole body dose in Section A.1.2.3.

Application

RETS require the dose rate due to noble gases in gaseous effluents be determined to be within the above limit in accordance with methodology specified in the ODCM (see Section 12.4 of each station's RETS and Technical Specifications).

To comply with this specification, each station uses an effluent radiation monitor setpoint corresponding to an offsite whole body dose rate at or below the limit (see Chapter 10). In addition, each station assesses compliance by calculating offsite whole body dose rate on the basis of periodic samples obtained in accordance with station procedures.

A.1.3.2 Skin Dose Rate

Requirement

RETS limit the skin dose rate due to noble gases in gaseous effluents released from a site to areas at and beyond the site boundary to less than or equal to a dose rate of 3000 mrem/yr at all times. (See Section 12.4 of each station's RETS and/or Technical Specifications)

Equation

The skin dose rate (shallow dose equivalent rate) due to noble gases released in gaseous effluents is calculated by the following expression:

$$\dot{D}_s = \sum \{ L_i [(X/Q)_s Q'_{is} + (X/Q)_v Q'_{iv} + (X/Q)_g Q'_{ig}] + (1.11) [S_i Q_{is} + V_i Q_{iv} + G_i Q_{ig}] \} \quad (A-9)$$

The summation is over noble gas radionuclides i .

| | | |
|-------------------------------------|---|-----------------|
| D_s | Skin Dose Rate | [mrem/yr] |
| | Dose rate to skin due to beta and gamma radiation from noble gas radionuclides released in gaseous effluents. | |
| Q'_{is} Q'_{iv} Q'_{ig} | Release Rate, Adjusted for Radiodecay | [μ Ci/sec] |
| | Measured release rate of radionuclide 'i' from a stack, vent, or ground level release point, reduced to account for radiodecay in transit from the release point to the dose point: | |
| | $Q'_{is} = Q_{is} \exp(-\lambda_i R/3600u_s)$ | (A-10) |
| | $Q'_{iv} = Q_{iv} \exp(-\lambda_i R/3600u_v)$ | (A-11) |
| | $Q'_{ig} = Q_{ig} \exp(-\lambda_i R/3600u_g)$ | (A-12) |

The parameters Q_{is} , Q_{iv} , and Q_{ig} are defined in Section A.1.3.1, and the parameters λ_i , R , u_s , u_v , and u_g are defined in Section A.1.2.2.

The remaining parameters have the same definitions as used in the equation for skin dose in Section A.1.2.4.

Application

RETS require the dose rate due to noble gases in gaseous effluents to be determined to be within the above limit in accordance with methodology specified in the ODCM. (See Section 12.4 of each station's RETS and Technical Specifications.

To comply with this specification, each station uses an effluent radiation monitor setpoint corresponding to an offsite skin dose rate at or below the limit (see Chapter 10). In addition, each station assesses compliance by calculating offsite skin dose rate on the basis of samples obtained periodically in accordance with station procedures.

A.1.4 Dose Due to Non-Noble Gas Radionuclides

Requirement

RETS provide the following limits, based on 10CFR50 Appendix I, on the dose to a member of the public from specified non-noble gas radionuclides in gaseous effluents released from each reactor unit to areas at and beyond the unrestricted area boundary:

- Less than or equal to 7.5 mrem to any organ during any calendar quarter.
- Less than or equal to 15 mrem to any organ during any calendar year.

The individual dose components are also required as part of the 40CFR190 assessments and combined as part of the 10CFR20 assessment (See Section A.4). The deep dose due to radionuclides deposited on the ground is considered to be a component of the deep dose equivalent for 10CFR20 and 40CFR190 compliance and an organ (whole body) dose component for 10CFR50 Appendix I compliance.

Note that as a result of historical regulation evolution, committed dose equivalent (CDE) assessments for 10CFR20 and 40CFR190 compliance are made for an adult using Federal Guidance Report No. 11 (Reference 93) dose conversion factors; assessments for 10CFR50 Appendix I compliance are made for 4 age groups (adult/teenager/child/infant) using Regulatory Guide 1.109 (Reference 6) dose conversion factors.

Equation

The committed dose equivalent (CDE) is calculated for releases in the time period under consideration.

Specifically, the CDE is calculated as the sum of two contributions:

$$D^{NNG}_{ja} = D^{inhal}_{ja} + D^{food}_{ja} \quad (A-13)$$

| | | |
|------------------|---|--------|
| D^{NNG}_{ja} | Committed Dose Equivalent (CDE) Due to Non-Noble Gas Radionuclides Sum of the committed dose equivalents to organ j of an individual of age group a due to non-noble gas radionuclides released in gaseous effluents during a specified time period. | [mrem] |
| D^{inhal}_{ja} | Inhalation Committed Dose Equivalent (CDE) CDE to organ j of an individual of age group a due to inhalation of non-noble gas radionuclides released in gaseous effluents. See Equation A-17 in Section A.1.4.2. | [mrem] |
| D^{food}_{ja} | Food Pathways Committed Dose Equivalent (CDE) CDE due to ingestion via food pathways (leafy vegetables, produce, milk, and meat) of non-noble gas radionuclides released in gaseous effluents. See Equation A-18 in Section A.1.4.3. | [mrem] |

Application

RETS require cumulative and projected dose contributions for the current calendar quarter and the current calendar year for the specified non-noble gas radionuclides in airborne effluents to be determined at least once per 31 days (see Section 12.4 of each station's RETS and Technical Specifications).

To comply with this specification, each nuclear power station obtains and analyzes samples in accordance with the radioactive gaseous waste or gaseous effluent sampling and analysis program in its RETS. For each organ of each age group considered (adult/teenager/child/infant), the dose for each pathway is calculated in every sector (except for sectors over water bodies). The calculation is based on the location assumptions discussed below in conjunction with the pathway equations. For each organ of each age group, the doses are summed in each sector over all pathways. The result for the sector with the highest total dose is compared to the limit.

For a release attributable to a processing or effluent system shared by more than one reactor, the dose due to an individual unit is obtained by proportioning the effluents among the units sharing the system. The allocation procedure is specified in ODCM Chapter 10.

The CDE evaluated for an adult is also included as part of the 10CFR20 and 40CFR190 assessment (See Section A.4).

A.1.4.1 Ground Deposition

The dose due to ground deposition of radioactivity is considered to be a whole body dose (deep dose equivalent) component and is calculated by the following expressions:

$$D^{gnd} = (24)(0.7)t_r \sum \{ DFG_i C_i^g \} \quad (A-14)$$

$$C_i^g = (d_i/\lambda_i)[1 - \exp(-\lambda_i t_b)] \quad (A-15)$$

$$d_i = [(1E6)/(24t_r)] \times [A'_{is}(D/Q)_s + A'_{iv}(D/Q)_v + A'_{ig}(D/Q)_g] \quad (\text{A-16})$$

The summation is over non-noble gas radionuclides 'i'.

| | | |
|--|--|-----------------------------------|
| D^{gnd} | Ground Deposition Deep Dose Equivalent (DDE) DDE due to ground deposition of non-noble gas radionuclides released in gaseous effluents. | [mrem] |
| 24 | Conversion Constant (days to hours) | [hr/day] |
| 0.7 | Shielding Factor; a dimensionless factor which accounts for shielding due to occupancy of structures. | |
| t_r | Release or Exposure Period Time period of the calculation (e.g., number of days in the quarter for a calendar quarter calculation). | [days] |
| DFG_i | Ground Plane Dose Conversion Factor Dose rate to the whole body per unit of ground radioactivity concentration due to standing on ground uniformly contaminated with radionuclide 'i'. See Table C-10 of Appendix C. | [(mrem/hr)/(pCi/m ³)] |
| C^G_i | Ground Plane Concentration Concentration of radionuclide 'i' on the ground. | [pCi/m ³] |
| d_i | Deposition Rate Rate at which radionuclide 'i' is deposited onto the ground. | [(pCi/hr)/m ²] |
| λ_i | Radiological Decay Constant Radiological decay constant for radionuclide 'i'. See Table C-7 of Appendix C. | [hr ⁻¹] |
| t_b | Time Period of Ground Deposition Time period during which the radioactivity on the ground is assumed to have been deposited. See Table C-1 of Appendix C. | [hr] |
| 1E6 | Conversion Constant (μCi to pCi) | [pCi/μCi] |
| A'_{is} A'_{iv} A'_{ig} | Cumulative Radionuclide Release, Adjusted for Radiodecay Measured cumulative release of radionuclide 'i' from a stack, vent, or ground level release point, reduced to account for radiodecay in transit from the release point to the dose point. See Section A.1.2.2. | [μCi] |
| (D/Q)_s | Relative Deposition Factor | [m ⁻²] |

$(D/Q)_v$
 $(D/Q)_g$

Rate of deposition of radioactivity at a specified location per unit of radioactivity release rate for a stack, vent, or ground level release. See Section 4.1.7, Section B.4 of Appendix B, and Table F-5 of Appendix F.

Application

The deep dose equivalent (DDE) due to ground deposition is determined for each sector using the highest calculated offsite value of D/Q for that sector. This value and the distance R to which it pertains are provided in Table F-5 of Appendix F. This dose component is included in the calculation of the total DDE (see equation A-35).

A.1.4.2 Inhalation

The committed dose equivalent (CDE) due to inhalation is calculated by the following expression:

$$D_{ja}^{inhal} = (3.17E-8)(1E6)(R_a) \times \sum \{ DFA_{ija} [(X/Q)_s A'_{is} + (X/Q)_v A'_{iv} + (X/Q)_g A'_{ig}] \} \tag{A-17}$$

The summation is over non-noble gas radionuclides 'i'.

| | | |
|------------------|--|----------------------|
| D_{ja}^{inhal} | Inhalation Committed Dose Equivalent (CDE) | [mrem] |
| | CDE to organ j of an individual in age group a due to inhalation of non-noble gas radionuclides released in gaseous effluents. | |
| 3.17E-8 | Conversion Constant (seconds to years) | [yrs/sec] |
| 1E6 | Conversion Constant (μ Ci to pCi) | [pCi/ μ Ci] |
| R_a | Individual Air Inhalation Rate | [m ³ /yr] |
| | The air intake rate for individuals in age group 'a'. See Table C-2 of Appendix C. | |
| DFA_{ija} | Inhalation Dose Commitment Factor | [mrem/pCi] |
| | Dose commitment to organ 'j' of an individual in age group 'a' per unit of activity of radionuclide 'i' inhaled. | |

| | <u>Assessment</u> | <u>Dose Factor</u> | <u>Age Group</u> |
|-----------------------------|--|---|------------------------------------|
| | 10CFR50 App.I | Reg. Guide 1.109 Tables E-7 through E-10 | All (four) |
| | 10CFR20/40CFR190 | Federal Guidance Report-11; Table 2.1 | Adult only (average individual) |
| $(X/Q)_s$ | Relative Effluent Concentration | | [sec/m ³] |
| $(X/Q)_v$ | Radioactivity concentration at a specified location per unit of radioactivity release rate. See Section 4.1.6, Section B.3 of Appendix B, and Table F-5 of Appendix F. | | |
| $(X/Q)_g$ | | | |
| $A'_{is}, A'_{iv}, A'_{ig}$ | Cumulative Radionuclide Release, Adjusted for Radiodecay | | [μ Ci] |

Measured cumulative release of radionuclide 'i' from a stack, vent, or ground level release point, reduced to account for radiodecay in transit from the release point to the dose point. See Section A.1.2.2.

Application

The CDE due to inhalation is determined for each sector using the highest calculated offsite value of X/Q for that sector. This value and the distance R to which it pertains are provided in Table F-5 of Appendix F. This dose component is included within the total CDE from all pathways (see equations A-13 and A-38).

A.1.4.3 Food Pathways

The committed dose equivalent (CDE) due to food pathways is calculated by the following expression:

$$D^{food}_{ja} = (t_r/365) \times \sum \{DFI_{ija} [i^{V}_{ia} + i^{P}_{ia} + i^{M}_{ia} + i^{F}_{ia}] \} \quad (A-18)$$

The summation is over non-noble gas radionuclides 'i'.

| | | |
|-----------------|---|------------|
| D^{food}_{ja} | Food Pathways Committed Dose Equivalent (CDE) CDE commitment to organ j of an individual in age group a due to ingestion via food pathways (leafy vegetables, produce, milk, and meat) of non-noble gas radionuclides released in gaseous effluents. | [mrem] |
| t_r | Time Period of Release or Exposure (e.g., number of days in a quarter for a calendar quarter calculation). | [days] |
| 1/365 | Conversion Constant (days to years) | [yr/day] |
| DFI_{ija} | Ingestion Dose Commitment Factor Dose commitment to organ 'j' of an individual in age group 'a' per unit of activity of radionuclide 'i' ingested. | [mrem/pCi] |

Assessment

10CFR50 App.I

Dose Factor

Reg. Guide 1.109
Tables E-11 through E-14.

Age Group

All (four)

10CFR20/40CFR190

Federal Guidance
Report-11; Table 2.2

Adult only
(average individual)

| | | |
|--|--|----------|
| $i^{V}_{ia}, i^{P}_{ia}, i^{M}_{ia}, i^{F}_{ia}$ | Rate of Ingestion of Activity Activity of radionuclide 'i' ingested annually by an individual in age group a from, respectively, the following: | [pCi/yr] |
| | <ul style="list-style-type: none"> • Leafy vegetables. • Produce (nonleafy vegetables, fruits, and grain). • Milk. • Meat (flesh). | |

Calculated as follows:

$$i^{V}_{ia} = U^V_a f_V C^V_i \quad (A-19)$$

$$i^{P}_{ia} = U^P_a f_P C^P_i \quad (A-20)$$

$$i^{M}_{ia} = U^M_a C^M_i \quad (A-21)$$

$$i_{ia}^F = U_a^F C_i^F \quad (A-22)$$

| | | |
|---------|-------------------------------|---------|
| U_a^V | Food Product Consumption Rate | [kg/yr] |
| U_a^P | | [kg/yr] |
| U_a^M | | [L/yr] |
| U_a^F | | [kg/yr] |

Annual consumption (usage) rate of leafy vegetables, produce, milk, or meat, respectively, for individuals in age group 'a'. See Table C-2 of Appendix C.

| | |
|-------|--|
| f_V | Food Product Affected Fraction |
| f_P | Fraction of ingested leafy vegetables (V) or produce (P) grown in the garden of interest. See Table C-1 of Appendix C. |

| | | |
|---------|--|----------|
| C_i^V | Food Product Radioactivity Concentration | [pCi/kg] |
| C_i^P | | [pCi/kg] |
| C_i^M | | [pCi/L] |
| C_i^F | | [pCi/kg] |

C_i^V and C_i^P represent, respectively, the average concentration of radionuclide *i* in leafy vegetables and produce grown in the garden of interest. Calculated from the amount of radioactivity released and the relative deposition factor *D/Q* at the garden of interest. See Section A.1.4.3.1 below for the equation.

C_i^M and C_i^F represent, respectively, the average concentration of radionuclide *i* in milk and meat from the producer of interest. Calculated from the amount of radioactivity released and the relative deposition factor *D/Q* at the locations of the producers of interest. See Sections A.1.4.3.2 and A.1.4.3.3 below for equations.

Application

The dose due to ingestion of leafy vegetables and produce is calculated in each sector for a hypothetical garden assumed to be located at the location of highest offsite *D/Q* (see Table F-5 of Appendix F). The dose due to ingestion of milk and meat is calculated in each sector for the location of the nearest producer as specified in Table F-6 of Appendix F. If there is no actual milk or meat producer within 5 miles of the station, one is assumed to be located at 5 miles (food pathway calculations are not made for sectors in which the offsite regions near the station are over bodies of water).

A.1.4.3.1 Vegetation

The radioactivity concentration in leafy vegetables (C_i^V), produce (C_i^P), or other vegetation is calculated by the following expression:

$$C_i = [(d_i)(r)/(Y_v)(\lambda_{ei})] \times [1 - \exp(-\lambda_{ei}t_e)] [\exp(-\lambda_i t_h)](f_r) \quad (A-23)$$

| | | |
|-------|--|----------------------------|
| C_i | Food Product Radioactivity Concentration | [pCi/kg] |
| | Average concentration of radionuclide 'i' in leafy vegetables, produce, or other vegetation. | |
| d_i | Deposition Rate | [(pCi/hr)/m ²] |
| | Rate at which radionuclide 'i' is deposited onto the ground. | |

Calculated from the amount of radioactivity released and the relative deposition factor D/Q at the location of interest. See Section A.1.4.1 for an equation. See the Subsection "Application" in Section A.1.4.3 for the location assumptions used in determining d.

| | | |
|-----------------------|--|----------------------|
| r | Vegetation Retention Factor | |
| | Fraction of deposited activity retained on vegetation. See Table C-1 of Appendix C. | |
| Y_v | Agricultural Productivity Yield | [kg/m ²] |
| | The quantity of vegetation produced per unit area of the land on which the vegetation is grown. See Table C-1 of Appendix C. | |
| λ_{Ei} | Effective Decay Constant | [hr ⁻¹] |
| | Effective removal rate constant for radionuclide 'i' from vegetation: | |
| | $\lambda_{Ei} = \lambda_i + \lambda_w$ | (A-24) |
| λ_i | Radiological Decay Constant | [hr ⁻¹] |
| | Radiological decay constant for radionuclide 'i'. See Table C-7 of Appendix C. | |
| λ_w | Weathering Decay Constant | [hr ⁻¹] |
| | Removal constant for physical loss by weathering. See Table C-1 of Appendix C. | |
| t_e | Effective Vegetation Exposure Time | [hr] |
| | Time that vegetation is exposed to contamination during the growing season. See Table C-1 of Appendix C. | |
| t_h | Harvest to Consumption Time | [hr] |
| | Time between harvest and consumption. See Table C-1 of Appendix C. | |
| f_f | Seasonal Growing Factor | |
| | Factor which accounts for the seasonal growth of vegetation. It has the value '1' during the growing season, '0' otherwise. See Table C-1 of Appendix C. | |

A.1.4.3.2 Milk

The radioactivity concentration in milk is calculated by the following expressions:

$$C^M_i = F_M C^f_i W_f \exp(-\lambda_i t_M) \quad (\text{A-25})$$

$$C^f_i = f_a f_g C^g_i + (1 - f_a) C^s_i + f_a (1 - f_g) C^s_i \quad (\text{A-26})$$

| | | |
|-------------|---|---------------------|
| C^M_i | <p>Milk Radioactivity Concentration Average concentration of radionuclide 'i' in milk from the producer of interest.</p> | [pCi/L] |
| F_M | <p>Milk Fraction Fraction of an animal's daily intake of radionuclide i which appears in each liter of milk (pCi/L in milk per pCi/day ingested by the animal). See Table C-3 of Appendix C.</p> | [days/L] |
| C^f_i | <p>Feed Concentration Average concentration of radionuclide 'i' in animal feed.</p> | [pCi/kg] |
| W_f | <p>Feed Consumption Amount of feed consumed by the animal each day. See Table C-1 of Appendix C.</p> | [kg/day] |
| λ_i | <p>Radiological Decay Constant Radiological decay constant for radionuclide 'i'. See Table C-7 of Appendix C.</p> | [hr ⁻¹] |
| t_M | <p>Milk Transport Time Average time from the production of milk to its consumption. See Table C-1 of Appendix C.</p> | [hr] |
| f_a | <p>Pasture Time Fraction Fraction of time that animals graze on pasture. See Table C-1 of Appendix C.</p> | |
| f_g | <p>Pasture Grass Fraction Fraction of daily feed that is pasture grass when animals graze on pasture. See Table C-1 of Appendix C.</p> | |
| C^g_i | <p>Pasture Grass Concentration Concentration of radionuclide 'i' in pasture grass. Calculated using Equation A-20 with the seasonal growing factor $f_r = 1$ and with parameter values specified for the pasture grass and milk pathways in Table C-1 of Appendix C.</p> | [pCi/kg] |
| C^s_i | <p>Stored Feed Concentration Concentration of radionuclide 'i' in stored feed. Calculated using Equation A-20 for C_i with the seasonal growing factor $f_r = 1$ and parameter values specified for the stored feed and milk pathways in Table C-1 of Appendix C.</p> | [pCi/kg] |

A.1.4.3.3 Meat

The radioactivity concentration in meat is calculated by the following expression:

$$C_i^F = F_F C_i^f W_f \exp(-\lambda_i t_s) \quad (\text{A-27})$$

| | | |
|-------------|---|---------------------|
| C_i^F | Meat Radioactivity Concentration Average concentration of radionuclide 'i' in meat from the producer of interest. | [pCi/kg] |
| F_F | Meat Fraction Fraction of an animal's daily intake of radionuclide 'i' which appears in each kilogram of flesh (pCi/kg in meat per pCi/day ingested by the animal). See Table C-3 of Appendix C. | [days/kg] |
| C_i^f | Feed Concentration Average concentration of radionuclide 'i' in animal feed. Calculated using the equation for C_i^f in the preceding sub-section with parameter values specified for the meat pathway in Table C-1 of Appendix C. | [pCi/kg] |
| W_f | Feed Consumption Amount of feed consumed by the animal each day. See Table C-1 of Appendix C. | [kg/day] |
| λ_i | Radiological Decay Constant Radiological decay constant for radionuclide 'i'. See Table C-7 of Appendix C. | [hr ⁻¹] |
| t_s | Time From Slaughter to Consumption See Table C-1 of Appendix C. | [hr] |

A.1.5 Dose Rate Due to Non-Noble Gas Radionuclides

Requirement

RETS limit the dose rate to any organ, due to radioactive materials in gaseous effluents released from a site to areas at and beyond the site boundary, to less than or equal to a dose rate of 1500 mrem/yr (see Section 12.4 of each station's RETS and Technical Specifications).

All stations consider the adult to be the receptor in calculating dose commitment to organs due to inhalation of non-noble gas radionuclides in gaseous effluents.

Equation

The dose rate to any adult organ due to inhalation is calculated by the following expression:

$$D_{ja}^{inhal} = (1E6)(R_a)\Sigma\{DFA_{ija}[(X/Q)_s Q'_{is} + (X/Q)_v Q'_{iv} + (X/Q)_g Q'_{ig}]\} \quad (\text{A-28})$$

The summation is over non-noble gas radionuclides 'i'.

| | | |
|-------------------------------------|--|-----------------|
| D_{ja}^{inhal} | Inhalation Dose Rate | [mrem/yr] |
| | Rate of dose commitment to organ <i>j</i> of an individual in age group <i>a</i> due to inhalation of non-noble gas radionuclides released in gaseous effluents; <i>j</i> and <i>a</i> are chosen to correspond to an adult thyroid. | |
| Q'_{is} Q'_{iv} Q'_{ig} | Radionuclide Release Rate, Adjusted for Radiodecay | [μ Ci/sec] |
| | Measured release rate of radionuclide 'i' from a stack, vent, or ground level release point, reduced to account for radiodecay in transit from the release point to the dose point. See Section A.1.3.2. | |

The other parameters are defined in Section A.1.4.2.

Application

RETS require the dose rate due to non-noble gas radioactive materials in airborne effluents be determined to be within the above limit in accordance with a sampling and analysis program specified in the RETS (see Section 12.4 of each station's RETS and Technical Specifications).

To comply with this specification, each station obtains and analyzes samples in accordance with the sampling and analysis program in its RETS. The adult organ dose rate due to inhalation is calculated in each sector at the location of the highest offsite X/Q. The result for the sector with the highest organ inhalation dose rate is compared to the limit.

A.1.6 Operability and Use of Gaseous Effluent Treatment Systems

Requirement

10CFR50 Appendix I and the station RETS require that the ventilation exhaust treatment system and the waste gas holdup system be used when projected offsite doses in 31 days, due to gaseous effluent releases, from each reactor unit, exceed any of the following limits:

- 0.2 mrad to air from gamma radiation.
- 0.4 mrad to air from beta radiation.
- 0.3 mrem to any organ of a member of the public.

The nuclear power stations are required to project doses due to gaseous releases from the site at least once per 31 days.

Each station calculates doses for all members of the public (adult, teenager, child and infant) and then determines the maximum dose. The member of the public who receives the maximum dose will be reported.

Equation

Offsite doses due to projected releases of radioactive materials in gaseous effluents are calculated using Equations A-1, A-2 and A-13. Projected cumulative radionuclide releases are used in place of measured cumulative releases A_{is} , A_{iv} and A_{ig} .

Application

For a release attributable to a processing or effluent system shared by more than one reactor unit, the dose due to an individual unit is obtained by proportioning the effluents among the units sharing the system. The allocation procedure is specified in Chapter 10 of this manual.

A.2 LIQUID RELEASES

A.2.1 Dose

Requirement

The design objectives of 10CFR50, Appendix I and RETS provide the following limits on the dose or dose commitment to a member of the public from radioactive materials in liquid effluents released from each reactor unit to restricted area boundaries:

- During any calendar quarter, less than or equal to 1.5 mrem to the total body and less than or equal to 5 mrem to any organ.
- During any calendar year, less than or equal to 3 mrem to the total body and less than or equal to 10 mrem to any organ.

The organ doses due to radioactivity in liquid effluents are also used as part of the 40CFR190 compliance and are included in the combination of doses to determine the Total Effective Dose Equivalent (TEDE) used to demonstrate 10CFR20 compliance. (See Section A.4)

As noted earlier, dose assessments for 10CFR20 and 40CFR190 compliance are made for an adult using Federal Guidance Report No. 11 (Reference 93) dose conversion factors. Dose assessments for 10CFR50 Appendix I compliance are made for four age groups (adult/teenager/child/infant) using Regulatory Guide 1.109 (Reference 6) dose conversion factors.

Equation

The dose commitment from radioactive materials in liquid effluents is calculated for the four age groups considering only the two principal pathways for radiation exposure. The dose commitment to each organ (and to the total body) is obtained as the sum of contributions from consumption of drinking water and fish:

$$D_{ja}^{liq} = D_{ja}^{water} + D_{ja}^{fish} \quad (A-29)$$

$$D_{ja}^{water} = (1.1E-3)(8760)(U_a^w M^w / F^w) \times \sum \{ A_i D F I_{ija} \exp(-\lambda_i t^w) \} \quad (A-30)$$

$$D_{ja}^{fish} = (1.1E-3)(8760)(U_a^f M^f / F^f) \times \sum \{ A_i B_i D F I_{ija} \exp(-\lambda_i t^f) \} \quad (A-31)$$

The summations are over i radionuclides.

| | | |
|------------------|--|--------|
| D_{ja}^{liq} | Total organ, and total body, dose commitment (CDE) Due to Radioactivity in Liquid Effluents | [mrem] |
| | Dose commitment to organ j (and total body) of age group a consuming water and fish containing radioactivity released in liquid effluents. | |
| D_{ja}^{water} | Committed Dose Equivalent (CDE) Due to Consumption of Drinking Water | [mrem] |

| | | |
|-----------------|--|---|
| | Dose commitment to organ j of age group a consuming water containing radioactivity released in liquid effluents. | |
| D_{ja}^{fish} | Committed Dose Equivalent (CDE) Due to Consumption of Fish | [mrem] |
| | Dose commitment to organ j of age group a consuming fish containing radioactivity released in liquid effluents. | |
| U_a^w, U_a^f | Usage Factor | [L/hr, kg/hr] |
| | Consumption rate of water (U_a^w) or fish (U_a^f). See Table C-2 of Appendix C. | |
| $1/M^w, 1/M^f$ | Dilution Factor | |
| | Measure of dilution prior to withdrawal of potable water or fish. See Table F-1 of Appendix F. | |
| F^w | Average Flow Rate | [cfs] |
| | Average flow rate of receiving body of water at point where Potable water is taken. See Table F-1 of Appendix F. | |
| F^f | Near-Field Flow Rate | [cfs] |
| | Near field flow rate of receiving body of water (in region where fish are taken). See Table F-1 of Appendix F. | |
| A_i | Radionuclide Release | [μ Ci] |
| | Measured amount of radionuclide 'i' released in liquid effluents during the time period under consideration. | |
| DFI_{ija} | Ingestion Dose Factor | [mrem/pCi] |
| | Dose commitment to organ j (and total body) of an individual in age group 'a' per unit of activity of radionuclide 'i' ingested. | |
| | <u>Assessment</u> 10CFR50 App.I | <u>Dose Factor</u> Reg. Guide 1.109 Tables E-11 through E-14. |
| | 10CFR20/40CFR190 | Federal Guidance Report-11; Table 2.2 |
| | | <u>Age Group</u> All (four) |
| | | Adult (average) |
| λ_i | Decay Constant Radiological decay constant of radionuclide 'i'. See Table C-7 of Appendix C. | [hr ⁻¹] |
| t^w, t^f | Elapsed Time | [hr] |

| | | |
|----------------------|---|----------------------------------|
| | Average elapsed time between release and consumption of potable water or fish. See Table F-1 of Appendix F. | |
| B_i | Bioaccumulation Factor | [L/kg] |
| | Equilibrium ratio of the concentration of radionuclide 'i' in fish (pCi/kg) to its concentration in water (pCi/L). See Table C-8 of Appendix C. | |
| 1.1E-3 | Conversion Constant | [(pCi/liter) per (μCi/yr)/(cfs)] |
| | Factor to convert to pCi/liter from (μCi/yr)/(cfs). | |
| 8760 | Conversion Constant (hours per year) | [hr/yr] |

Application

RETS require determination of cumulative and projected dose contributions from liquid effluents for the current calendar quarter and the current calendar year at least once per 31 days. (see Section 12.3 of each station's RETS and/or Technical Specifications).

For a release attributable to a processing or effluent system shared by more than one reactor unit, the dose due to an individual unit is obtained by proportioning the effluents among the units sharing the system. The allocation procedure is specified in ODCM Chapter 10.

A.2.2 Liquid Effluent Concentrations Requirement

Requirement

One method of demonstrating compliance to the requirements of 10CFR20.1301 is to demonstrate that the annual average concentrations of radioactive material released in gaseous and liquid effluents do not exceed the values specified in 10CFR20 Appendix B, Table 2; Column 2. (See 10CFR 20.1302(b)(2).) However, as noted in Section A.5.1, this mode of 10CFR20.1301 compliance has not been elected.

As a means of assuring that annual concentration limits will not be exceeded, and as a matter of policy assuring that doses by the liquid pathway will be ALARA; RETS provides the following restriction:

"The concentration of radioactive material released in liquid effluents to unrestricted areas shall be limited to ten times the concentration values in Appendix B, Table 2, Column 2 to 10CFR20.1001-20.2402."

This also meets the requirement of Station Technical Specifications and RETS.

Equation

According to the footnotes to 10CFR20 Appendix B, Table 2; Column 2, if a radionuclide mix of known composition is released, the concentrations must be such that

$$\sum\{C_i / 10 ECL_i\} \leq 1 \tag{A-32}$$

where the summation is over index i (radionuclides).

| | | |
|------------------------|--|----------|
| C_i | Radioactivity Concentration in Liquid Effluents to the Unrestricted Area | [μCi/mL] |
| | Concentration of radionuclide 'i' in liquid released to the unrestricted area. | |
| ECL_i | Effluent Concentration Limit in Liquid | [μCi/mL] |

Effluents Released to the Unrestricted Area

The allowable annual average concentration of radionuclide 'i' in liquid effluents released to the unrestricted area. This concentration is specified in 10CFR20 Appendix B, Table 2; Column 2. Concentrations for noble gases are different and are specified in the stations' Technical Specifications/RETS.

10

Multiplier to meet the requirements of Technical Specifications (if approved).

If either the identity or concentration of any radionuclide in the mixture is not known, special rules apply. These are given in the footnotes in 10CFR20 Appendix B, Table 2; Column 2.

Application

The RETS and Technical Specifications require a specified sampling and analysis program to assure that liquid radioactivity concentrations at the point of release are maintained within the required limits.

To comply with this provision, each nuclear power station obtains and analyzes samples in accordance with the radioactive liquid waste (or effluent) sampling and analysis program in its RETS. Radioactivity concentrations in tank effluents are determined in accordance with Equation A-33 in the next section. Comparison with the Effluent Concentration Limit is made using Equation A-32.

A.2.3 Tank Discharges

When radioactivity is released to the unrestricted area with liquid discharge from a tank (e.g., a radwaste discharge tank), the concentration of a radionuclide in the effluent is calculated as follows:

$$C_i = (C_i^d)(F^d)/(F^d + F^t) \quad (\text{A-33})$$

| | | |
|---------|--|-----------------------|
| C_i | Concentration in Liquid effluent to the unrestricted area. | [$\mu\text{Ci/mL}$] |
| | Concentration of radionuclide 'i' in liquid released to the unrestricted area | |
| C_i^d | Concentration in the Discharge Tank | [$\mu\text{Ci/mL}$] |
| | Measured concentration of radionuclide 'i' in the discharge tank. | |
| F^t | Flow Rate, Tank Discharge | [cfs] |
| | Measured flow rate of liquid from the discharge tank to the initial dilution stream. | |
| F^d | Flow Rate, Initial Dilution Stream | [cfs] |
| | Measured flow rate of the initial dilution stream that carries the radionuclides to the unrestricted area boundary (e.g., circulating cooling water or blowdown from a cooling tower or lake). | |

A.2.4 Tank Overflow

Requirement

To limit the consequences of tank overflow, the RETS/Technical Specifications may limit the quantity of radioactivity that may be stored in unprotected outdoor tanks. Unprotected tanks are tanks that are not surrounded by liners, dikes, or walls capable of holding the tank contents and that do not have tank overflows and surrounding area drains connected to the liquid radwaste treatment system. The specific objective is to provide assurance that in the event of an uncontrolled release of a tank's contents, the resulting radioactivity concentrations beyond the unrestricted area boundary, at the nearest potable water supply and at the nearest surface water supply, will be less than the limits of 10CFR20 Appendix B, Table 2; Column 2.

The Technical Specifications and RETS may contain a somewhat similar provision. For most nuclear power stations, specific numerical limits are specified on the number of curies allowed in affected tanks.

Application

Table F-1 of Appendix F provides information on the limits applicable to affected stations. The limits are as stated for some stations in the station Technical Specifications.

A.2.5 Operability and Use of the Liquid Radwaste Treatment System

Requirement

The design objectives of 10CFR50, Appendix I and RETS/Technical Specifications require that the liquid radwaste treatment system be operable and that appropriate portions be used to reduce releases of radioactivity when projected doses due to the liquid effluent from each reactor unit to restricted area boundaries exceed either of the following (see Section 12.3 of each station's RETS or Technical Specifications);

- 0.06 mrem to the whole body in a 31 day period.
- 0.2 mrem to any organ in a 31 day period.

Equation

Offsite doses due to projected releases of radioactive materials in liquid effluents are calculated using Equation A-29. Projected radionuclide releases are used in place of measured releases A_i .

A.2.6 Drinking Water

Five nuclear power stations (Braidwood, Dresden, LaSalle, Quad Cities, and Zion) have requirements for calculation of drinking water dose that are related to 40CFR141, the Environmental Protection Agency National Primary Drinking Water Regulations. These are discussed in Section A.6.

A.2.7 Non-routine Liquid Release Pathways

Cases in which normally non-radioactive liquid streams (such as the Service Water) are found to contain radioactive material are non-routine will be treated on a case specific basis if and when this occurs. Since each station has sufficient capacity to delay a liquid release for reasonable periods of time, it is expected that planned releases will not take place under these circumstances. Therefore, the liquid release setpoint calculations need not and do not contain provisions for treating multiple simultaneous release pathways.

A.3 DOSE DUE TO CONTAINED SOURCES

There are presently two types of contained sources of radioactivity which are of concern in ComEd offsite radiological dose assessments. The first source is that due to gamma rays from nitrogen-16 (N^{16}) carried over to the turbine in BWR steam. The second source is that due to gamma rays associated with radioactive material resident in onsite radwaste storage facilities.

Gamma radiation from these sources contributes to the whole body dose (deep dose equivalent).

A.3.1 BWR Skyshine

The contained onsite radioactivity source which results in the most significant offsite radiation levels at ComEd nuclear power stations is skyshine resulting from N¹⁶ decay inside turbines and steam piping at boiling water reactor (BWRs).

The N¹⁶ that produces the skyshine effect is formulated through neutron activation of the oxygen atoms (oxygen-16, or O¹⁶) in reactor coolant as the coolant passes through the operating reactor core. The N¹⁶ travels with the steam produced in the reactor to the steam driven turbine. While the N¹⁶ is in transport, it radioactively decays with a half-life of about 7 seconds and produces 6 to 7 MeV gamma rays. Typically, offsite dose points are shielded from a direct view of components containing N¹⁶, but there can be skyshine radiation at offsite locations due to scattering of gamma rays off the mass of air above the steamlines and turbine.

The offsite dose rate due to skyshine has been found to have the following dependencies:

- The dose rate decreases as distance from the station increases.
- The dose rate increases non-linearly as the power production level increases.
- The dose rate increases when hydrogen is added to the reactor coolant, an action taken to improve reactor coolant chemistry characteristics (see Reference 39).

To calculate offsite dose in a given time period due to skyshine, a boiling water nuclear power station must track the following parameters:

- The total gross energy E_h produced with hydrogen being added.
- The total gross energy E_o produced without hydrogen being added.

The turbines at BWR sites are sufficiently close to each other that energy generated by the two units at each site may be summed.

An initial estimate of BWR skyshine dose is calculated per the following equation:

$$D^{sky} = (K) (E_o + M_h E_h) \times \sum \{OF_k SF_k \exp(-0.007R_k)\} \quad (A-34)$$

The summation is over all locations k occupied by a hypothetical maximally exposed member of the public characterized by the parameters specified in Table F-8. The parameters in Equation A-34 are defined as follows:

| | | |
|------------------------|--|-----------------|
| D^{sky} | Dose Due to N-16 Skyshine Gamma dose (deep dose equivalent) due to BWR N-16 skyshine for the time period of interest. | [mrem] |
| K | Empirical Constant A constant determined by fitting data measured at the each station. | [mrem/(MWe-hr)] |
| E_o | Electrical Energy Generated Without Hydrogen Addition Total gross electrical energy generated without hydrogen addition in the time period of interest. | [MWe-hr] |
| E_h | Electrical Energy Generated with Hydrogen Addition | [MWe-hr] |

| | | |
|--------|---|--------------------|
| | Total gross electrical energy generated with hydrogen addition in the period of interest. | |
| M_h | Multiplication Factor for Hydrogen Addition | |
| | Factor applied to offsite dose rate when skyshine is present. Hydrogen addition increases main steam line radiation levels typically up to a factor of approximately 5 (see Page 8-1 of Reference 39). M_h is station specific and is given in Table F-8 of Appendix F. | |
| OF_k | Occupancy Factor | |
| | The fraction of time that the dose recipient spends at location 'k' during the period of interest. See Table F-8 of Appendix F. | |
| SF_k | Shielding Factor | |
| | A dimensionless factor that accounts for shielding due to occupancy of structures. $SF_k = 0.7$ if there is a structure at location k; $SF_k = 1.0$ otherwise. See Table F-8 of Appendix F. | |
| 0.007 | Empirical Constant | [m ⁻¹] |
| | A constant determined by fitting data measured at the Dresden station (see Reference 45). | |
| R_k | Distance | [m] |
| | Distance from the turbine to location 'k'. See Table F-8 of Appendix F. | |

A.3.2 Dose from Onsite Radwaste Storage Facilities

Low level radioactive waste may be stored at any, or all ComEd nuclear power stations in the following types of storage facilities:

- Interim Radwaste Storage Facility (IRSF)
- Concrete vaults containing 48 radwaste liners (48-Pack)
- Dry Active Waste (DAW) facilities
- Butler buildings/warehouses
- Steam generator storage facilities

The "48-Pack" is a shielded concrete vault which is designed to hold three tiers of radwaste liners in a four by four array. The outer shell of the "48-Pack" is a three-foot thick concrete wall and a two and one-half foot thick concrete cover slab. The vault is placed on a poured concrete slab. The liners may have an average surface dose rate of fifteen (15) rem per hour (or up to 380 rem/hr if a 50.59 evaluation has been completed).

The DAW facility will contain low-level radioactive waste that would result in dose rates less than the 10CFR20 requirements.

Preliminary locations for the 48-Packs and the DAW facilities have been selected for each station. Preliminary dose assessments, which include site-specific occupancy factors, indicate that the expected doses, to members of the public, when fully loaded, will be well within the 40CFR190 annual limits.

The dose rates resulting from these radwaste storage facilities will be monitored frequently as they are being utilized, and if necessary, a dose calculation model similar to that of Equation A-34 will be developed and placed in the ODCM.

A.4 Total Dose Limits (10CFR20 and 40CFR190)

The regulatory requirements of 10CFR20 and 40CFR190 each require "total" doses to be assembled in an appropriate form. Sections A.1 and A.2 considered organ doses from the gaseous and liquid effluent streams. The regulations of 10CFR20 and 40CFR190 also require consideration of direct radiation exposure from contained sources of radioactivity. Section A.3 addresses the direct radiation component. The following sections will describe the methodology of assessing direct radiation dose and then the manner in which the various doses are combined to obtain the appropriate "total" for regulatory compliance purposes.

Annual dose limits in 10CFR20 are now expressed in terms of Total Effective Dose Equivalent (TEDE) where radiation exposures due to inhalation, ingestion and external sources are appropriately weighted to provide a uniform risk based comparison. As defined in 10CFR20, TEDE is equal to the sum of the deep-dose equivalent from external exposures and the committed effective dose equivalent (CEDE) from internal exposures.

A.4.1 Deep Dose Equivalent

The deep dose equivalent, H_d , is comprised of three parts:

- 1) Whole body dose (deep dose equivalent) due to noble gas radionuclides in gaseous effluents (Section A.1.2),
- 2) Dose due to contained sources (Section A.3) and
- 3) Whole body dose due to radioactivity deposited on the ground (Section A.1.4.1).

Expressed as an equation using the notation used in this appendix, then;

$$H_d = D_{wb} + D^{sky} + D^{gnd} \quad (A-35)$$

| | | |
|-----------|--|--------|
| H_d | Deep Dose Equivalent (DDE) Dose equivalent due to external whole-body exposure at a tissue depth of 1 cm. | [mrem] |
| D_{wb} | Whole Body Dose, Effluents DDE due to gamma radiation from noble gas radionuclides released in gaseous effluents. See Equation A-6. | [mrem] |
| D^{sky} | Dose Due to N-16 Skyshine DDE due to skyshine for the period of interest. See Equation A-34. | [mrem] |
| D^{gnd} | Dose From Ground Deposition DDE due to ground deposition of non-noble gas radionuclides released in gaseous effluents. See Equation A-14. | [mrem] |

A.4.2 Committed Effective Dose Equivalent (CEDE)

The CEDE for internal exposures ($H_{E,50}$) is the sum of the products of the weighting factors applicable to each of the body organs, or tissues, that are irradiated and the committed dose equivalent (CDE) to those tissues.

$$H_{E,50} = \sum_T W_T H_{T,50} \quad (A-36)$$

| | | |
|------------|---|--------|
| $H_{E,50}$ | Committed Effective Dose Equivalent The committed effective dose equivalent due to internal exposures. | [mrem] |
| W_T | Weighting Factor The weighting factor for organ or tissue (T) which is the proportion of stochastic effects resulting from the irradiation of that organ or tissue to the total risk of stochastic effects when the whole body is irradiated uniformly. Values of W_T are given in Reference #93, Federal Guidance Report 11 and in 10CFR20. | |
| $H_{T,50}$ | Committed Dose Equivalent The total dose equivalent to organs or tissues (T) that will be received, after an intake of radioactive material by an individual, over the 50 year period following the intake. | [mrem] |

The general methodology for calculating the committed dose equivalents from airborne releases is given in Section A.1.4; and from liquid releases in Section A.2.1. In terms of parameters developed earlier in this document, then,

$$H_{T,50} = D^{NNG}_{ja} + D^{liq}_{ja} \quad (A-37)$$

| | | |
|----------------|---|--------|
| D^{NNG}_{ja} | CDE Due to Non-Noble Gas Radionuclides The sum of the dose and dose commitment to organ j of an individual of age group 'a' due to non-noble gas radionuclides released in gaseous effluents during a specified period. See Equation A-13. | [mrem] |
| D^{liq}_{ja} | CDE for an Adult Due to Radioactivity Released in Liquid Effluents The CDE commitment to organ j of an individual of age group 'a' resulting from consumption water and fish containing radioactivity released in liquid effluents during a specified period. See Equation A-29. | [mrem] |

In order to be consistent with the dose factor data, upon which the current revision of 10CFR20 is based, the CDEs D^{NNG}_{ja} and D^{liq}_{ja} are now calculated using the dose factor data included in Federal Guidance Report No. 11. (Reference 93). The Regulatory Guide 1.109 dose factors (Reference 6 and ODCM, Appendix C) are still used for 10CFR50 Appendix I compliance.

A.4.3 Total Effective Dose Equivalent

The above relationships may then be combined into a single equation for the total effective dose equivalent, TEDE, as follows:

$$TEDE = H_d + H_{E,50} = D_{wb} + D^{sky} + D^{gnd} + \sum_T W_T (D^{NNG}_{ja} + D^{liq}_{ja}) \quad (A-38)$$

| | | |
|--------|---|--------|
| $TEDE$ | Total Effective Dose Equivalent The sum of the deep dose equivalent (for external exposures) and the committed effective dose equivalent (for internal exposures). | [mrem] |
|--------|---|--------|

A.5 COMPLIANCE TO TOTAL DOSE LIMITS

A.5.1 Total Effective Dose Equivalent Limit - 10CFR20 Compliance

Requirement

Each station's RETS limits the Total Effective Dose Equivalent (TEDE) to an annual limit of 100 mrem, as required by 10CFR20.1301 (a)(1). The regulations offer licensees the option of demonstrating compliance by one of two methods 10CFR20.1302 (b)(1) or 10CFR20.1302 (b)(2). The RETS state that the 10CFR20.1302 (b)(1) methodology has been selected to demonstrate compliance to 10CFR20.1301 (a)(1).

The general methodology for calculating the TEDE is given in Section A.4.3. In lieu of specific regulatory guidance, this evaluation is conservatively made for an adult living at the nearest residence.

In August of 1995, a revision to 10CFR20 was implemented that changed the definition of a member of the public. As a result, for each nuclear station, estimated doses were calculated for a member of the public who enters the site boundary, but is not authorized for unescorted access to the protected area of the site and does not enter any radiologically posted areas on the site. Realistic assumptions were made for occupancy times and locations visited while within the site boundary.

These evaluations indicate that the doses estimated for these members of the public are well within the 10CFR20 limits. These dose evaluations will be performed annually and if necessary, a model will be developed and included in the ODCM.

Equation

The TEDE is evaluated using Equation A-38.

Application

This evaluation is used to demonstrate compliance to 10CFR20 and satisfy station RETS and Technical Specifications (see Chapter 12).

A.5.2 Total Dose due to the Uranium Fuel Cycle (40CFR190)

Requirement

RETS and 40CFR190 limit the annual (calendar year) dose or dose commitment to any member of the public due to releases of radioactivity and to radiation from uranium fuel cycle sources to the following:

- Less than or equal to 25 mrem to the whole body.
- Less than or equal to 25 mrem to any organ except the thyroid.
- Less than or equal to 75 mrem to the thyroid.

Total Dose Components

This requirement includes the total dose from operations at the nuclear power station. This includes doses due to radioactive effluents (airborne and liquid) and dose due to direct radiation from non-effluent sources (e.g., sources contained in systems on site). It also includes dose due to plants under consideration, neighboring plants and dose due to other facilities in the uranium fuel cycle.

The operations comprising the uranium fuel cycle are specified in 40CFR190.02(b). The following are included to the extent that they directly support the production of electrical power for public use utilizing nuclear energy:

- Milling of uranium ore.
- Chemical conversion of uranium.

- Isotopic enrichment of uranium.
- Fabrication of uranium fuel.
- Generation of electricity by a light-watered-cooled nuclear power plant using uranium fuel
- Reprocessing of spent uranium fuel.

Excluded are:

- Mining operations.
- Operations at waste disposal sites.
- Transportation of any radioactive material in support of these operations.
- The re-use of recovered non-uranium special nuclear and by-product materials from the cycle.

When Compliance Assessment is Required

The calculation of compliance to 40CFR190 regulations is now required as part of demonstration of compliance to 10CFR20 regulations.

Equation

The dose due to the uranium fuel cycle is determined with equations A-35 and A-37, sections A.4.1 and A.4.2 respectively.

A.5.3 Summary of Compliance Methodology

The required compliance is given in Tables 2-1, 2-2 and 2-3. In Table 2-1, the dose components are itemized and referenced, and an indication of their regulatory application is noted. A more detailed compliance matrix is given in Table 2-3. The locations of dose receivers for each dose component are given in Table 2-2.

Further, Table 2-2 states the location of the receiver and occupancy factors, if applicable. In general, the receiver spends time in locations that result in maximum direct dose exposure and inhales and ingests radioactivity from sites that yield maximum pathway doses. Thus, the dose calculated is a very conservative one compared to the "average" receiver who does not go out of his way to maximize radioactivity uptakes. Finally, the connection between regulations, the ODCM equations and the station RETS and Technical Specifications is given in Table 12-0.

A.6 DOSE DUE TO DRINKING WATER (40CFR141)

The National Primary Drinking Water Regulations, 40CFR141, contain the requirements of the Environmental Protection Agency applicable to public water systems. Included are limits on radioactivity concentration. Although these regulations are directed at the owners and operators of public water systems, several stations have requirements in their Technical Specifications related to 40CFR141.

A.6.1 40CFR141 Restrictions on Manmade Radionuclides

Section 141.16 states the following:

- (a) The average annual concentration of beta particle and photon radioactivity from man-made radionuclides in drinking water shall not produce an annual dose equivalent to the total body or any internal organ greater than 4 millirem/year.
- (b) Except for the radionuclides listed in Table A-0, the concentration of man-made radionuclides causing 4 mrem total body or organ dose equivalents shall be calculated on the basis of drinking 2 liter of water per day. (Using the 168 hour data listed in "Maximum Permissible Body Burdens and Maximum Permissible Concentration of Radionuclides in Air or Water for Occupational Exposure, "NBSHandbook 69 as amended August 1963, U.S. Department of Commerce.). If two or more

radionuclides are present, the sum of their annual dose equivalents to the total body or any organ shall not exceed 4 millirem/year.

TABLE A-0
AVERAGE ANNUAL CONCENTRATIONS ASSUMED TO
PRODUCE A TOTAL BODY OR ORGAN DOSE OF 4 MREM/YR

| Radionuclide | Critical Organ | pCi / liter |
|--------------|----------------|-------------|
| Tritium | Total body | 20,000 |
| Strontium-90 | Bone marrow | 8 |

A.6.2 Application

The projection or calculation of dose due to the drinking water pathway is made using Equation A-30. Projections are made using projected radionuclides releases in place of measured releases A_i . Doses calculated using Equation A-30 may differ from doses determined by the methodology prescribed in 40CFR141.16.

When required, a nuclear power station prepares a special report on radiological impact at the nearest community water system. This system is taken as the one listed in Table A-3 of this appendix. The report should include the following:

- The doses calculated by Equation A-30.
- A statement identifying the dose calculation methodology (e.g., a reference to this manual).
- A statement that the doses calculated by the ODCM methodology are not necessarily the same as doses calculated by the methodology prescribed in 40CFR141.16.
- The data used to calculate the doses. This information includes the amounts of radioactivity released and the flow rate and dilution values used (see Table F-1). This information is provided to assist the operator of the community water system in performing its own dose assessment.

Table A-1

COMPLIANCE MATRIX

| Regulation | Dose to be compared to limit |
|--|---|
| 10CFR50 Appendix I | <ul style="list-style-type: none"> • Gamma air dose and beta air dose due to airborne radioactivity in effluent plume. • Whole body and skin dose due to airborne radioactivity in effluent plume are reported only if certain gamma and beta air dose criteria are exceeded. • CDE for all organs and all four age groups due to iodine and particulate in effluent plume. All pathways are considered. • CDE for all organs and all four age groups due to radioactivity in liquid effluents. |
| 10CFR20 | <ul style="list-style-type: none"> • TEDE, totaling all deep dose equivalent components (direct, ground and plume shine) and committed effective dose equivalents (all pathways, both airborne and liquid-borne). CDE evaluation is made for adult only using FGR 11 database. |
| 40CFR190 (now, by reference, also part of 10CFR20) | <ul style="list-style-type: none"> • Whole body dose (DDE) due to direct radiation, ground and plume exposure from all sources at a station. • Organ doses (CDE) to an adult due to all pathways. |
| RETS/ODCM | <ul style="list-style-type: none"> • "Instantaneous" whole body (DDE), thyroid (CDE) and skin (SDE) dose rates to an adult due to radioactivity in airborne effluents. For the thyroid dose only inhalation is considered. • "Instantaneous" concentration limits for liquid effluents. |

Table A-2
Release Point Classifications

| <u>Station</u> | <u>Release Point</u> | <u>Release Point Classification^a</u> |
|-------------------|--|---|
| Braidwood 1 & 2 | Vent Stacks | Vent (Mixed Mode) |
| Byron 1 & 2 | Vent Stacks | Vent (Mixed Mode) |
| Dresden 1 | Plant Chimney | Stack (Elevated) |
| Dresden 2 & 3 | Chimney | Stack (Elevated) |
| | Reactor Building Ventilation | Vent (Mixed Mode) |
| | Exhaust Stack | |
| LaSalle 1 & 2 | Main Station Vent Stack | Stack (Elevated) |
| | Standby Gas Treatment Stack ^b | Stack (Elevated) |
| Quad Cities 1 & 2 | Chimney | Stack (Elevated) |
| | Reactor Building Ventilation | Vent (Mixed Mode) |
| | Exhaust Stack | |
| Zion 1 & 2 | Vent Stacks | Ground Level |

^aThese classifications are based on Sargent & Lundy NSLD Calculation No. CEC-4-88; Rev. 0, 10/19/88. The definitions of release point classifications (stack, vent and ground level) are given in Section 4.1.4.

^bThe LaSalle standby gas treatment stack is located inside the main station vent stack.

Table A-3
Nearest Downstream Community Water Systems

Characteristics of Nearest
Affected Downstream Community
Water Supply

| <u>Station</u> | <u>ComEd Nuclear Facilities Upstream of Station</u> | <u>Location and Distance^a</u> | <u>Other ComEd Nuclear Stations Upstream of Water Supply</u> |
|----------------|---|--|--|
| Braidwood | None | Wilmington, 5 river miles | None |
| Byron | None | None within 115 river miles | NA ^b |
| Dresden | Braidwood | Peoria, 106 river miles | Braidwood LaSalle |
| LaSalle | Braidwood Dresden | Peoria, 97 river miles | Braidwood Dresden |
| Quad Cities | None | E. Moline, 16 river miles | None |
| Zion | None | Lake County Intake, 1.4 miles | None |

^aODCM Bases and Reference Document (Reference 101) Table O-2 and O-6 provide the bases of the location and distance data.

^bNA = not applicable. For purposes of the calculations in the ODCM, there are no community water supplies affected by liquid effluents from Byron Station. This is based on the absence of community water supplies between the Byron Station liquid discharge to the Rock River and the confluence of the Rock and Mississippi Rivers, 115 miles downstream.

Table A-4

40CFR190 Compliance

| 40CFR190 Dose | Annual Limit (mrem) | ODCM Equivalent Dose and Equation Number |
|---------------|---------------------|---|
| Whole Body | 25 | Deep Dose Equivalent; A-35 |
| Thyroid | 75 | Thyroid Committed Dose Equivalent; A-37 evaluated for thyroid |
| Other Organs | 25 | Organ Committed Dose Equivalent; A-37 evaluated for all organs except thyroid |

Notes:

1. The evaluation is made considering the following sources:
 - a. Radioactivity in contained sources within the station;
 - b. Radioactivity in station gaseous and liquid effluents.
2. Dose contributions from neighboring stations and other facilities in the nuclear fuel cycle.

APPENDIX B

MODELS AND PARAMETERS FOR AIRBORNE and LIQUID EFFLUENT CALCULATIONS

TABLE OF CONTENTS

| SECTION 1: Models and Parameters for AIRBORNE Effluent Calculations | <u>PAGE</u> |
|--|-------------|
| B.0 INTRODUCTION | B-1 |
| B.1 METEOROLOGICAL DATA AND PARAMETERS | B-1 |
| 1. Data | B-2 |
| 2. Joint Frequency Distribution | B-2 |
| 1. Downwind Direction Versus Upwind Direction | B-2 |
| 2. Stack JFD | B-3 |
| 3. Ground Level JFD | B-3 |
| 4. Vent JFDs | B-3 |
| 3. Average Wind Speed | B-4 |
| 1. Stack Release | B-5 |
| 2. Ground Level Release | B-5 |
| 3. Vent Release | B-5 |
| B.2 GAUSSIAN PLUME MODELS | B-6 |
| 1. Mathematical Representation | B-6 |
| 2. Sector-Averaged Concentration | B-7 |
| B.3 RELATIVE CONCENTRATION FACTOR X/Q | B-7 |
| 1. Stack Release | B-8 |
| 1. Effective Release Height | B-9 |
| 1. Plume Rise | B-9 |
| 2. Terrain Effects | B-11 |
| 2. Ground Level Release | B-11 |
| 3. Vent Release | B-12 |
| 4. Removal Mechanisms | B-12 |
| B.4 RELATIVE DEPOSITION FACTOR D/Q | B-12 |
| 1. Stack Release | B-13 |
| 2. Ground Level Release | B-14 |
| 3. Vent Release | B-14 |
| B.5 GAMMA AIR DOSE FACTORS (S_j, V_j, G_j) | B-15 |
| 1. Stack Release | B-15 |
| 2. Ground Level Release | B-17 |
| 3. Vent Release | B-17 |

APPENDIX B
Table of Contents (Cont'd)

| | | <u>PAGE</u> |
|---|---|-------------|
| B.6 | WHOLE BODY DOSE FACTORS ($\bar{S}_i, \bar{V}_i, \bar{G}_i$) | B-18 |
| | 1. Stack Release | B-18 |
| | 2. Ground Level Release | B-18 |
| | 3. Vent Release | B-19 |
| B.7 | BETA AIR AND SKIN DOSE FACTORS (L_i, \bar{L}_i) | B-19 |
| B.8 | GROUND PLANE DOSE CONVERSION FACTOR DFG_i | B-19 |
| B.9 | INHALATION DOSE COMMITMENT FACTOR DF_{ijja} | B-20 |
| B.10 | INGESTION DOSE COMMITMENT FACTOR DF_{ijja} | B-20 |
| B.11 | MEASURED RELEASE PARAMETERS | B-20 |
| B.12 | RADIOLOGICAL DECAY CONSTANTS | B-20 |
| B.13 | PRODUCTION/EXPOSURE PARAMETERS | B-20 |
| SECTION 2: Models and Parameters for LIQUID Effluent Calculations: | | |
| B.14 | INTRODUCTION | B-21 |
| B.15 | DOSE. | B-21 |
| | 1. Drinking Water | B-21 |
| | 2. Aquatic Foods (Fish) | B-22 |
| | 3. Parameters | B-22 |
| | 1. Flow, Dilution, and Transport Time | B-22 |
| | 1. River Model | B-22 |
| | 2. Lake Michigan Model | B-23 |
| | 2. Dose Factors | B-23 |
| | 3. Measured Releases | B-23 |
| | 4. Radiological Decay | B-23 |
| | 5. Consumption | B-24 |
| B.16 | CONCENTRATION IN TANK DISCHARGES | B-24 |

APPENDIX B

LIST OF TABLES

| <u>NUMBER</u> | <u>TITLE</u> | <u>PAGE</u> |
|---------------|--|-------------|
| B-1 | Portion of an Example Joint Frequency Distribution | B-25 |

LIST OF FIGURES

| <u>NUMBER</u> | <u>TITLE</u> | <u>PAGE</u> |
|---------------|--|-------------|
| B-1 | Instantaneous View of a Plume | B-26 |
| B-2 | A Gaussian Curve | B-27 |
| B-3 | Effect of Observation Period on Plume Shape | B-28 |
| B-4 | A Gaussian Plume | B-29 |
| B-5 | Illustration of Model for Calculating Dose Due to Radioactivity Release | B-30 |
| B-6 | Illustration of Model for Dilution of Tank Discharge | B-31 |

SECTION 1:

MODELS AND PARAMETERS FOR AIRBORNE EFFLUENT CALCULATIONS

B.0 INTRODUCTION

The equations used for calculation of doses due to radioactive airborne effluents are given in Section A.1 of Appendix A. The equations involve the following types of parameters:

- **Meteorological Parameters**
These include X/Q , D/Q , and wind speed. Their values are based on historical average atmospheric conditions at a site for a selected multi-year historical period (see Section 4.1.5).
- **Dose Factors**
These parameters are used to provide a simple way to calculate doses and dose rates due to gamma and beta radiation. Some of these parameters are independent of meteorological conditions and therefore generic (i.e., not station-specific). Others have values based on historical average atmospheric conditions for a selected multi-year historical period and are therefore station-specific.
- **Measured Release Parameters**
These are measured values of radioactivity releases and release rates.
- **Radiological Decay Constants**
These are used to account for the radioactive decay between the release of radioactivity to the environment and the exposure of persons to it.
- **Production/Exposure Parameters**
These are parameters characterizing agricultural production (e.g., length of growing season, transport times) and human exposure patterns (e.g., exposure period, breathing rate, food consumption rates). These parameters affect the quantities of radioactivity to which persons may be exposed.

This appendix discusses the methodology used to determine values of these parameters. Section B.1 addresses how the historical meteorology of a site is characterized by use of a function called the joint frequency distribution. Section B.1 and Sections B.3 through B.6 present equations that use the joint frequency distribution to obtain values for site-specific meteorological and dose parameters. Most of these equations involve a mathematical model of a plume known as the Gaussian plume model. This model is developed in Section B.2. Various generic dose factors are discussed in Sections B.7 through B.10. The other parameters are discussed in the remaining sections.

B.1 METEOROLOGICAL DATA AND PARAMETERS

Predicting where airborne effluent will travel requires information on the following:

- Wind speed
- Wind direction
- Atmospheric turbulence

The greater the atmospheric turbulence, the more an effluent plume will tend to broaden and the more dilute the concentration will be. Atmospheric turbulence is affected by the general condition of the atmosphere (e.g., the vertical temperature distribution) and by local features (e.g., objects that protrude into the wind stream). A commonly used classification scheme for the degree of atmospheric turbulence associated with the general condition of the atmosphere involves seven stability classes:

- A Extremely Unstable
- B Moderately Unstable
- C Slightly Unstable
- D Neutral
- E Slightly Stable
- F Moderately Stable
- G Extremely Stable

This classification scheme is based on Reference 5, Table 1. Each class is associated with a particular range of wind direction fluctuations and of vertical temperature gradients in the atmosphere. These are specified in Table C-4 of Appendix C.

B.1.1 Data

Historical atmospheric conditions at each nuclear power station were recorded by an instrumented meteorological tower that measured wind speed, wind direction, and temperature at various heights. Hourly average values of wind speed, wind direction, and stability class were determined. The difference in temperature between two heights was used to assign an atmospheric stability class based on the correlation between temperature gradient and stability class in Table C-4 of Appendix C.

In obtaining the data, quality assurance checks and corrections were made. Also, corrections were applied to compensate for the limitations of wind sensors at low speeds. A calm was said to exist if the wind speed was less than that of the threshold of either the anemometer (wind speed meter) or the wind direction vane. For calm conditions, a wind speed equal to one-half of the higher threshold was assigned. For each stability class, the wind directions during calm conditions were assumed to be distributed in proportion to the observed wind direction distribution of the lowest non-calm wind speed class.

B.1.2 Joint Frequency Distribution

The data for a particular historical period are summarized by developing a joint frequency distribution (JFD). Each such distribution specifies the fraction of time during the historical period that the following jointly occur:

- Wind speed within a particular range (wind speed class).
- Downwind direction in one of the 16 sectors corresponding to the 16 principal compass directions (N, NNE, etc.).
- Atmospheric conditions corresponding to one of the seven atmospheric stability classes discussed in Section B.1. Table B-1 of this appendix displays a portion of an example JFD.

Different JFDs are associated with the different release classifications defined in Section 4.1.4. One JFD is defined for stack releases, and another JFD is defined for ground level releases. Two JFDs are associated with vent (mixed mode) releases, one for the portion of the time the release is treated as elevated and the other for the portion of the time the release is treated as ground level.

B.1.2.1 Downwind Direction Versus Upwind Direction

Unless otherwise noted, any reference to wind direction in this document represents downwind direction, i.e., the direction in which the wind is blowing toward. This is because the parameters developed in this document are used to calculate radioactivity concentration and radiation dose downwind of a release point. In contrast, it is conventional for meteorologists to provide JFDs based on upwind direction, the direction from which the wind is blowing. For example, the JFDs presented in the annual operating reports of the nuclear power stations are obtained from a meteorological contractor and the directions specified in the reports are upwind directions. Users of JFDs should always be careful to ascertain whether the directions specified are upwind or downwind.

B.1.2.2 Stack JFD

For a stack release, the JFD is defined as follows:

$\Sigma f_s(n, \theta, c)$ Joint Frequency Distribution, Stack Release

The fraction of hours during a period of observation that all of the following hold:

- The average wind speed is within wind speed class n .
- The downwind direction is within the sector denoted by θ .
- The atmospheric stability class is c .

This function is defined for application to a stack release point (see Section 4.1.4). Its value is based on hourly average wind data obtained at a height representative of the release point height.

The stack JFD is normalized to 1:

$$\Sigma f_s(n, \theta, c) = 1 \quad (\text{B-1})$$

The summation is over all wind speed classes n , all compass direction sectors θ , and all stability classes c .

B.1.2.3 Ground Level JFD

For a ground level release, the JFD $f_g(n, \theta, c)$ is defined in the same way as for a stack release except that the wind data are obtained at a height representative of a ground level release point. This height is taken as about 10 meters.

The ground level JFD is normalized to 1:

$$\Sigma f_g(n, \theta, c) = 1 \quad (\text{B-2})$$

The summation is over all wind speed classes n , all compass direction sectors, and all stability classes c .

B.1.2.4 Vent JFDs

In accordance with the approach recommended in Regulatory Guide 1.111 (Reference 7), the plume from a vent release is treated as elevated part of the time and as ground level the rest of the time. Two JFDs are determined:

- $f_{v,elev}(n, \theta, c)$ characterizes the plume during the part of the time that it is considered elevated;
- $f_{v,gnd}(n, \theta, c)$ characterizes the plume during the part of the time that it is considered ground level.

Their definitions are as follows:

$f_{v,elev}(n, \theta, c)$ Joint Frequency Distribution, Elevated Portion of a Vent Release

The fraction of hours during a period of observation that the plume is considered elevated and that all of the following hold:

- The average wind speed is within wind speed class **n**.
- The downwind direction is within the sector denoted by θ .
- The atmospheric stability class is **c**.

$f_{v,gnd}(n,\theta,c)$ Joint Frequency Distribution,
Ground Level Portion of a Vent Release

The fraction of hours during a period of observation that the plume is considered ground level and that all of the following hold:

- The average wind speed is within wind speed class **n**.
- The downwind direction is within the sector denoted by θ .
- The atmospheric stability class is **c**.

The value of **$f_{v,elev}(n, \theta, c)$** is based on hourly average wind data at a height representative of the vent release point. Where the measurement height differed considerably from the release height, wind speed data for the release height was obtained by extrapolation. The value of **$f_{v,gnd}(n, \theta, c)$** is based on hourly average wind data obtained at a height representative of a ground level release point. This is taken as about 10 meters.

The sum of these two JFDs is normalized to 1:

$$\Sigma\{ f_{v,elev}(n, \theta, c) + f_{v,gnd}(n, \theta, c) \} = 1 \quad (B-3)$$

The summation is over all wind speed classes **n**, all compass direction sectors θ , and all stability classes **c**.

The prescription of Regulatory Guide 1.111 is used in determining the fraction of time that the plume is considered elevated and the fraction of time that it is considered ground level. The fractions are obtained from the ratio of stack exit velocity **W_o** to hourly average wind speed **u** at the height of the vent release point as follows:

• If **$W_o/u > 5$** , then the plume is considered elevated for the hour.

• If **$W_o/u \leq 1$** , then the plume is considered ground level for the hour.

• If **$1 < W_o/u \leq 5$** , the plume is considered to be a ground level release for a fraction **G_t** of the hour and an elevated release for a fraction **$(1 - G_t)$** of the hour where **G_t** is defined as follows:

$$G_t = 2.58 - 1.58(W_o/u) \quad \text{for } 1.0 < W_o/u \leq 1.5 \quad (B-4)$$

$$G_t = 0.30 - 0.06(W_o/u) \quad \text{for } 1.5 < W_o/u \leq 5.0 \quad (B-5)$$

B.1.3 Average Wind Speed

Using the joint frequency distribution, average wind speeds are obtained for each station. Values are obtained for each downwind direction (N, NNE, etc.) and for various release point classifications (stack, vent, and ground level).

B.1.3.1 Stack Release

For a stack release, the following formula is used:

$$u_s(\theta) = \frac{\sum \{ f_s(n, \theta, c) u_n \}}{\sum \{ f_s(n, \theta, c) \}} \quad (\text{B-6})$$

where the summations are over wind speed classes **n** and stability classes **c**.

$u_s(\theta)$ Average Wind Speed, Stack Release [m/sec]

The average wind speed in downwind direction θ for a stack release.

u_n Wind Speed for Class **n** [m/sec]

A wind speed representative of wind speed class **n**. For each wind speed class except the highest, u_n is the average of the upper and lower limits of the wind speed range for the class. For the highest wind speed class, u_n is the lower limit of the wind speed range for the class.

The parameter f_s is defined in Section B.1.2.2.

B.1.3.2 Ground Level Release

For a ground level release, the following formula is used:

$$u_g(\theta) = \frac{\sum \{ f_g(n, \theta, c) u_n \}}{\sum \{ f_g(n, \theta, c) \}} \quad (\text{B-7})$$

where the summations are over wind speed classes **n** and stability classes **c**.

$u_g(\theta)$ Average Wind Speed, Ground Level Release [m/sec]

The average wind speed in downwind direction θ for a ground level release.

The parameter f_g is defined in Section B.1.2.3.

B.1.3.3 Vent Release

For a vent release, the following formula is used:

$$u_v(\theta) = \frac{\sum \{ [f_{v,elev}(n, \theta, c) + f_{v,gnd}(n, \theta, c)] u_n \}}{\sum \{ f_{v,elev}(n, \theta, c) + f_{v,gnd}(n, \theta, c) \}} \quad (\text{B-8})$$

where the summations are over wind speed classes **n** and stability classes **c**.

$u_v(\theta)$ Average Wind Speed, Vent Release [m/sec]

The average wind speed in downwind direction θ for a vent release.

The parameters $f_{v,elev}$ and $f_{v,gnd}$ are defined in Section B.1.2.4.

B.2 GAUSSIAN PLUME MODELS

As a plume of airborne effluents moves away from an elevated release point, the plume both broadens and meanders. It has been found that the time-averaged distribution of material in an effluent plume can be well represented mathematically by a Gaussian function.

B.2.1 Mathematical Representation

In a widely used form of the Gaussian plume model, the distribution of radioactivity in a plume is represented mathematically by the equation below:

$$X(x,y,z) = [Q/(2\pi \sigma_y \sigma_z u)] \exp(-y^2/2\sigma_y^2) \times \{ \exp[-(z-h_e)^2/2\sigma_z^2] + \exp[-(z+h_e)^2/2\sigma_z^2] \} \quad (\text{B-9})$$

$X(x,y,z)$ Radioactivity Concentration [μCi/m³]

The concentration of radioactivity at point (x,y,z). The x, y, and z axis are defined as follows:

x Downwind Distance [m]
 Distance from the stack along an axis parallel to the wind direction.

y Crosswind Distance [m]
 Distance from the plume centerline along an axis parallel to the crosswind direction.

z Vertical Distance [m]
 Distance from the ground (grade level at the stack) along an axis parallel to the vertical direction.

Q Release Rate [μCi/sec]
 Release rate of radioactivity.

σ_y, σ_z Horizontal and Vertical Dispersion Coefficients [m]
 Standard deviations of the Gaussian distributions describing the plume cross-sections in the y and z directions, respectively. The values of σ_y and σ_z depend on several parameters:

- Downwind distance x.
 Because a plume broadens and meanders as it travels away from its release point, the values of σ_y and σ_z increase as x increases.
- Atmospheric stability class.
 The plume is broadest for extremely unstable atmospheric conditions (Class A) and narrowest for extremely stable conditions (Class G).
- Time period of averaging plume concentration.

The values of σ_y and σ_z increase as the averaging period increases.

| | | |
|----------------------|---|---------|
| u | Average Wind Speed | [m/sec] |
| | The average wind speed. The average speed of travel of the plume in the x direction. | |
| h_e | Effective Release Height | [m] |
| | The effective height of effluent release above grade elevation. This may be greater than the actual release height (see Section B.3.1.1.1). | |

The two exponential functions of **z** in the curly brackets of Equation B-9 represent the emitted and reflected components of the plume. The reflected component (represented by the exponential with **(z + h_e)** in its argument) arises from the assumption that all material in a portion of the plume that touches ground is reflected upward. This assumption is conservative if one is calculating airborne radioactivity concentration.

B.2.2 Sector-Averaged Concentration

Sometimes, it is desired to determine the average concentration of radioactivity in a sector due to release at a constant rate over an extended period of time (e.g., a year). For such a case, it is reasonable to assume that the wind blows with equal likelihood toward all directions within the sector. From Equation B-9, the following equation for ground level radioactivity concentration can be derived:

$$X_{\text{sector}} = [2.032 f Q / (\sigma_z u x)] \exp(-h^2_e / 2\sigma_z^2) \quad (\text{B-10})$$

| | | |
|---------------------------|--|-----------------------|
| X_{sector} | Sector-Averaged Ground Level Concentration | [μCi/m ³] |
| | The time-averaged concentration of airborne radioactivity in a sector at ground level at a distance x from the release point. | |
| 2.032 f | A dimensionless constant. Sector Fraction | |
| | The fraction of time that the wind blows into the sector. | |
| Q | Release rate of radioactivity. | [μCi/sec] |

The other parameter definitions are the same as for Equation B-9.

B.3 RELATIVE CONCENTRATION FACTOR X/Q

The relative concentration factor **X/Q** (called "chi over Q") provides a simple way of calculating the radioactivity concentration at a given point in an effluent plume when the release rate is known:

$$X = Q (X/Q) \quad (\text{B-11})$$

| | | |
|----------|---|-----------------------|
| X | Concentration of Radioactivity Concentration of radioactivity at point (x,y,z) in the atmosphere. | [μCi/m ³] |
| Q | Release Rate | [μCi/sec] |

Release rate of radioactivity.

X/Q Relative Concentration Factor [sec/m³]
Relative concentration factor for point (x,y,z). The airborne radioactivity concentration at (x,y,z) per unit release rate.

Expressions for X/Q based on Gaussian plume models can be obtained from the equations for concentration X in Section B.2 simply by dividing both sides of each equation by the release rate Q. For example, from Equation B-10, we obtain the following expression for the sector-averaged X/Q:

$$(X_{\text{sector}}/Q) = [2.032 f / (\sigma_z u x)] \exp(-h_e^2 / 2\sigma_z^2) \quad (\text{B-12})$$

The values of X/Q used in ODCM calculations are both sector-averaged and time-averaged. The time averaging is based on the historical average atmospheric conditions of a specified multi-year time period (see Section 4.1.5) and is accomplished by use of the joint frequency distribution discussed in Section B.1.2. The formulas used to obtain the time- and sector-averaged X/Q are based on Equation B-12, but vary depending on whether the release is a stack, ground level, or vent release. The three cases are discussed below.

B.3.1 Stack Release

For a stack release, the relative concentration factor is designated (X/Q)_s. Its value is obtained by the following formula:

$$(X/Q)_s = (2.032/R) \sum \{ f_s(n,\theta,c) \times [\exp(-h_e^2 / 2\sigma_z^2)] / (u_n \sigma_z) \} \quad (\text{B-13})$$

The summation is over wind speed classes n and atmospheric stability classes c.

| | | |
|-----------------------------|---|-----------------------|
| (X/Q)_s | Relative Concentration Factor, Stack Release | [sec/m ³] |
| | The time- and sector-averaged relative concentration factor due to a stack release for a point at ground level at distance R in downwind direction θ. | |
| 2.032 | Constant | |
| | A dimensionless constant. | |
| R | Downwind Distance | [m] |
| | The downwind distance from the release point to the point of interest. | |
| f_s(n,θ,c) | Joint Frequency Distribution, Stack Release | |
| | This function is defined in Section B.1.2.2. | |
| h_e | Effective Release Height | [m] |
| | The effective height of an effluent release above grade elevation. For a stack release, h _e is obtained by correcting the actual height of the release point for plume rise, terrain effects, and downwash as described in Section B.3.1.1, below. | |

| | | |
|------------|--|---------|
| σ_z | Standard Vertical Dispersion Coefficient | [m] |
| | A coefficient characterizing vertical plume spread in the Gaussian model for stability class c at distance R (see Table C-5 of Appendix C). | |
| u_n | Wind Speed | [m/sec] |
| | A wind speed representative of wind speed class n . For each wind speed class except the highest, u_n is the average of the upper and lower limits of the wind speed range for the class. For the highest wind speed class, u_n is the lower limit of the wind speed range for the class. | |

This expression is recommended by the NRC in Regulatory Guide 1.111 (Reference 7) and is based on a model designated there as the "constant mean wind direction model." In this model it is assumed that the mean wind speed, the mean wind direction, and the atmospheric stability class determined at the release point also apply at all points within the region in which airborne concentration is being evaluated.

B.3.1.1 Effective Release Height

For a stack release, the effective height of an effluent plume is the height of the release point corrected for plume rise and terrain effects:

If $(h_s + h_{pr} - h_t) < 100$ meters, then

$$h_e = h_s + h_{pr} - h_t \tag{B-14}$$

If $(h_s + h_{pr} - h_t) \geq 100$ meters, then;

$$h_e = 100 \text{ meters} \tag{B-15}$$

| | | |
|-------|--------------------------|-----|
| h_e | Effective Release Height | [m] |
|-------|--------------------------|-----|

The effective height of an effluent release above grade elevation.

| | | |
|-------|-----------------------|-----|
| h_s | Actual Release Height | [m] |
|-------|-----------------------|-----|

The actual height of the release above grade elevation.

| | | |
|----------|------------|-----|
| h_{pr} | Plume Rise | [m] |
|----------|------------|-----|

The rise of the plume due to its momentum and buoyancy. (See Section B.3.1.1.1.)

| | | |
|-------|------------------------------|-----|
| h_t | Terrain Correction Parameter | [m] |
|-------|------------------------------|-----|

A parameter to account for the effect of terrain elevation on the effective height of a plume. Taken as zero (see Section B.3.1.1.2).

B.3.1.1.1 Plume Rise

Because nuclear power stations generally have plumes that are not significantly warmer than room temperature, plume rise due to buoyancy is neglected. The formulas used to calculate plume rise due to momentum are given below.

Stability Classes A, B, C, and D

For these stability classes (corresponding to unstable and neutral conditions), h_{pr} is taken as the lesser of two quantities:

$$h_{pr} = \text{Minimum of } [(h_{pr})_1, (h_{pr})_2] \quad (\text{B-16})$$

$$(h_{pr})_1 = (1.44)(W_o/u)^{2/3}(R/d)^{1/3}(d) - h_d \quad (\text{B-17})$$

$$(h_{pr})_2 = (3)(W_o/u)(d) \quad (\text{B-18})$$

W_o Stack Exit Velocity [m/sec]

The effluent stream velocity at the discharge point.

u Wind Speed [m/sec]

R Downwind Distance [m]

The downwind distance from the release point to the point of interest.

d Internal Stack Diameter [m]

The internal diameter of the stack from which the effluent is released.

h_d Downwash Correction [m]

A parameter to account for downwash at low exit velocities.

The parameter h_d is calculated by the following equations:

$$h_d = (3)(1.5 - W_o/u)(d) \text{ if } W_o < 1.5u \quad (\text{B-19})$$

$$h_d = 0 \text{ if } W_o \geq 1.5u \quad (\text{B-20})$$

Note that $(h_{pr})_1$ can increase without limit as R increases; thus, the effect of $(h_{pr})_2$ is to limit calculated plume rise at large distances from the nuclear power station.

Stability Classes E, F, and G

For these stability classes (corresponding to stable conditions), h_{pr} is taken as the minimum of four quantities:

$$h_{pr} = \text{Minimum of } [(h_{pr})_1, (h_{pr})_2, (h_{pr})_3, (h_{pr})_4] \quad (\text{B-21})$$

$$(h_{pr})_3 = (4)(F/S)^{1/4} \quad (\text{B-22})$$

$$(h_{pr})_4 = (1.5)(F/u)^{1/3}(S)^{-1/6} \quad (\text{B-23})$$

F Momentum Flux Parameter [m⁴/sec²]

A parameter defined as:

$$F = W_o^2(d/2)^2 \quad (\text{B-24})$$

S Stability Parameter [1/sec²]

A parameter defined as follows:

| Stability Class | S |
|-----------------|----------|
| E | 8.70E-4 |
| F | 1.75E-3 |
| G | 2.45E-3 |

The quantities $(h_{pr})_1$ and $(h_{pr})_2$ are as defined by Equations B-17 and B-18.

B.3.1.1.2 Terrain Effects

Due to general flatness of the terrain in the vicinity of the stations, the terrain correction parameter h_t was taken as zero in all calculations of meteorological dispersion and dose parameters for this Manual.

B.3.2 Ground Level Release

For a ground level release, the relative concentration factor is designated $(X/Q)_g$. Its value is obtained by the following formula:

$$(X/Q)_g = (2.032/R) \sum \{ f_g(n,\theta,c)/(u_n S_z) \} \quad (B-25)$$

The summation is over wind speed classes n and atmospheric stability classes c .

$(X/Q)_g$ Relative Concentration Factor, Ground Level Release [sec/m³]

The time- and sector-averaged relative concentration factor due to a ground level release for a point at ground level at distance R in downwind direction θ .

$f_g(n,\theta,c)$ Joint Frequency Distribution, Ground Level Release

This function is defined in Section B.1.2.3.

S_z Wake-Corrected Vertical Dispersion Coefficient [m]

The vertical dispersion coefficient corrected for building wake effects. The correction is made as described below.

The remaining parameters are defined in Section B.3.1.

Wake-Corrected Vertical Dispersion Coefficient

The wake-corrected vertical dispersion coefficient S_z in Equation B-25 is taken as the lesser of two quantities:

$$S_z = \text{Minimum of } [(S_z)_1, (S_z)_2] \quad (B-26)$$

$$(S_z)_1 = [\sigma_z^2 + D^2/(2\pi)]^{1/2} \quad (B-27)$$

$$(S_z)_2 = (\sigma_z)(3^{1/2}) \quad (B-28)$$

| | | |
|------------|---|-----|
| S_z | Wake-Corrected Vertical Dispersion Coefficient | [m] |
| | The vertical dispersion coefficient corrected for building wake effects. | |
| σ_z | Standard Vertical Dispersion Coefficient | [m] |
| | The coefficient characterizing vertical plume spread in the Gaussian model for stability class c at distance R (see Table C-5 of Appendix C). | |
| D | Maximum Height of Neighboring Structure | [m] |
| | The maximum height of any neighboring structure causing building wake effects (see Table F-2 of Appendix F). | |

B.3.3 Vent Release

For a vent release, the relative concentration factor is designated $(X/Q)_v$. Its value is obtained by the following formula:

$$(X/Q)_v = (2.032/R) \sum \{ f_{v,elev}(n,\theta,c) \times [\exp(-h^2_e/2\sigma_z^2)]/(u_n \sigma_z) + f_{v,gnd}(n,\theta,c)/(u_n S_z) \} \quad (B-29)$$

The summation is over wind speed classes **n** and atmospheric stability classes **c**.

| | | |
|-----------|---|-----------------------|
| $(X/Q)_v$ | Relative Concentration Factor, Vent Release | [sec/m ³] |
|-----------|---|-----------------------|

The time and sector averaged relative concentration factor due to a vent release for a point at ground level at distance **R** in downwind direction θ .

The parameters $f_{v,elev}(n,\theta,c)$ and $f_{v,gnd}(n,\theta,c)$ are defined in Section B.1.2.4. The parameter S_z is defined in Section B.3.2. The remaining parameters are defined in Section B.3.1.

B.3.4 Removal Mechanisms

In Regulatory Guide 1.111, the NRC allows various removal mechanisms to be considered in evaluating the radiological impact of airborne effluents. These include radioactive decay, dry deposition, wet deposition, and deposition over water. Radiological decay is taken into account in the equations of this manual which use X/Q (see Appendix A).

For simplicity, the other removal mechanisms cited by the NRC are not accounted for in the evaluation or use of X/Q in this manual. This represents a conservative approximation as ignoring removal mechanisms increases the value of X/Q .

B.4 RELATIVE DEPOSITION FACTOR D/Q

The quantity D/Q (called "D over Q") is defined to provide the following simple way of calculating the rate of deposition of radioactivity at a given point on the ground when the release rate is known.

$$d = Q (D/Q)$$

(B-30)

| | | |
|------------|--|-------------------------------------|
| d | Deposition Rate | [($\mu\text{Ci}/\text{m}^2$)/sec] |
| | Rate of deposition of radioactivity at a specified point on the ground. | |
| Q | Release Rate of radioactivity. | [$\mu\text{Ci}/\text{sec}$] |
| D/Q | Relative Deposition Factor | [1/m ²] |
| | Relative deposition factor for a specified point on the ground. The deposition rate per unit release rate. | |

The values of **D/Q** used in this manual are time-averaged. The time averaging is based on the historical average atmospheric conditions of a specified multi-year time period (see Section 4.1.5) and is accomplished by use of the joint frequency distribution described in Section B.1.2. The formulas used to obtain **D/Q** vary depending on whether the release is a stack, ground level, or vent release. The three cases are discussed below.

B.4.1 Stack Release

For a stack release, the relative deposition factor is designated **(D/Q)_S**. Its value is obtained by the following formula:

$$(D/Q)_S = [1/(2\pi R/16)] \sum \{f_S(n,\theta,c) D_r(c,R,h_e)\} \quad \text{(B-31)}$$

The summation is over wind speed classes **n** and stability classes **c**.

| | | |
|---|---|---------------------|
| (D/Q)_S | Relative Deposition Factor, Stack Release | [1/m ²] |
| | The time-averaged relative deposition factor due to a stack release for a point at distance R in the direction θ . | |
| 2π/16 | Sector Width | [radians] |
| | The width of a sector over which the plume direction is assumed to be uniformly distributed (as in the model of Section B.2.2). Taken as 1/16 of a circle. | |
| R | Downwind Distance | [m] |
| | The downwind distance from the release point to the point of interest. | |
| f_S(n,θ,c) | Joint Frequency Distribution, Stack Release | |
| | This function is defined in Section B.1.2.2. | |
| D_r(c,R,h_e) | Relative Deposition Rate, Stack Release | [m ⁻¹] |
| | The deposition rate per unit downwind distance [$\mu\text{Ci}/(\text{sec}\cdot\text{m})$] divided by the source strength [$\mu\text{Ci}/\text{sec}$] due to a stack release for stability class c , downwind distance R , and effective release height h_e . | |

The value is based on Figures 7 to 9 of Regulatory Guide 1.111, which apply, respectively, to release heights of 30, 60, and 100 m. Linear interpolation is used to obtain values at intermediate release heights. If the effective release height is greater than 100 meters, then the data for 100 meters are used.

h_e Effective Release Height [m]

The effective height of the release above grade elevation.
See Section B.3.1.1.

B.4.2 Ground Level Release

For ground level release, the relative deposition factor is designated $(D/Q)_g$. Its value is obtained by the following formula:

$$(D/Q)_g = [1/(2\pi R/16)] D_r(R) \sum \{ f_g(n,\theta,c) \} \quad (B-32)$$

The summation is over wind speed classes n and stability classes c .

$(D/Q)_g$ Relative Deposition Factor, Ground Level Release [1/m²]

The time-averaged relative deposition factor due to a ground level release for a point at distance R in the direction θ .

$f_g(n,\theta,c)$ Joint Frequency Distribution, Ground Level Release

This function is defined in Section B.1.2.3.

$D_r(R)$ Relative Deposition Rate, Ground Level [m⁻¹]

The deposition rate per unit downwind distance [$\mu\text{Ci}/(\text{sec}\cdot\text{m})$] divided by the source strength [$\mu\text{Ci}/\text{sec}$] due to a ground level release for downwind distance R . The value is taken from Figure 6 of Regulatory Guide 1.111 and is the same for all atmospheric stability classes.

The remaining parameters are defined in Section B.4.1.

B.4.3 Vent Release

For a vent release, the relative deposition factor is designated $(D/Q)_v$. Its value is obtained by the following formula:

$$(D/Q)_v = [1/(2\pi R/16)] \times [\sum \{ f_{v,elev}(n,\theta,c) D_r(c,R,h_e) \} + D_r(R) \sum \{ f_{v,gnd}(n,\theta,c) \}] \quad (B-33)$$

The summation is over wind speed classes n and stability classes c .

$(D/Q)_v$ Relative Deposition Factor, Vent Release [1/m²]

The time-averaged relative deposition factor due to a ground level release for a point at distance R in the direction θ .

The parameters $f_{v,elev}(n,\theta,c)$ and $f_{v,ground}(n,\theta,c)$ are defined in Section B.1.2.4. The remaining parameters are defined in Sections B.4.1 and B.4.2.

B.5 GAMMA AIR DOSE FACTORS (S_i , V_i , G_i)

The gamma air dose factors provide a simple way of calculating doses and dose rates to air due to gamma radiation. For example, using a dose factor DF_i , gamma air dose rate may be calculated as follows:

$$\dot{D} = \sum \dot{D}_i \quad (B-34)$$

$$\dot{D}_i = \sum \{Q_i DF_i\} \quad (B-35)$$

The summations are over i radionuclides.

| | | |
|-------------|---|-----------------------------|
| \dot{D} | Gamma Air Dose Rate | [mrad/yr] |
| | The gamma air dose rate due to all radionuclides released. | |
| \dot{D}_i | Gamma Air Dose Rate Due to Radionuclide i | [mrad/yr] |
| Q_i | Release Rate of Radionuclide i | [μ Ci/sec] |
| DF_i | Gamma Air Dose Factor for Radionuclide i | [(mrad/yr)/(μ Ci/sec)] |
| | A factor used to calculate gamma air dose or dose rate due to release of radionuclide i . Gamma air dose rate at a particular location per unit release rate. | |

Three gamma air dose factors are defined: S_i , V_i , and G_i . They are used for stack, vent, and ground level releases, respectively. These three release point classifications are defined in Section 4.1.4. The calculation of the three dose factors is discussed below.

B.5.1 Stack Release

For a stack release, the gamma air dose factor S_i is obtained by a model similar to that of Equation 6 of Regulatory Guide 1.109 (Reference 6). A sector-averaged Gaussian plume is assumed and the dose factor is evaluated on the basis of historical average atmospheric conditions. The value of S_i depends on distance R from the release point and on downwind sector θ .

The following equation is used:

$$S_i = [260/(2\pi R/16)] \times \sum \{f_s(n,\theta,c)[\exp(-\lambda_i R/3600u_n)] \times E_k \mu_a(E_k) A_{Kl} I(h_e, u_n, c, \sigma_z, E_k)/u_n\} \quad (B-36)$$

The summation is over wind speed classes n , atmospheric stability classes c , and photon group indices k .

| | | |
|-------|---|-----------------------------|
| S_i | Gamma Air Dose Factor, Stack Release | [(mrad/yr)/(μ Ci/sec)] |
| | The gamma air dose factor at ground level for a stack release for radionuclide i , downwind sector θ , downwind distance R from the release point, and the average atmospheric conditions of a specified historical time period. | |

| | | |
|-------------------------------------|---|---|
| 260 | Conversion factor | [(mrad-radians-m ³ -disintegrations)/(sec-MeV-Ci)] |
| | Reconciles units of Equation B-36. | |
| 2π/16 | Sector Width | [radians] |
| | The width of a sector over which the plume direction is assumed to be uniformly distributed (as in the model of Section B.2.2). Taken as 1/16 of a circle. | |
| f_s(n,θ,c) | Joint Frequency Distribution, Stack Release | |
| | This function is defined in Section B.1.2.2. | |
| λ_i | Radiological Decay Constant | [hr ⁻¹] |
| | Radiological Decay Constant for radionuclide i (see Table C-7 of Appendix C). | |
| 3600 | Conversion Factor | [sec/hr] |
| | The number of seconds per hour. Used to convert wind speed in meters/sec to meters/hr. | |
| E_k | Photon Group Energy | [MeV/photon] |
| | An energy representative of photon energy group k . The photons emitted by each radionuclide are grouped into energy groups in order to facilitate analysis. All photons with energy in energy group k are assumed to have energy E_k . | |
| μ_a(E_k) | Air Energy Absorption Coefficient | [m ⁻¹] |
| | The linear energy absorption coefficient for air for photon energy group k . The fraction of energy absorbed in air per unit of distance traveled for a beam of photons of energy E_k . Distance is measured in units of linear thickness (meters). | |
| A_{ki} | Effective Photon Yield | [photons per disintegration] |
| | The effective number of photons emitted with energy in energy group k per decay of nuclide i . On the basis of Section B.1 of Regulatory Guide 1.109 (Reference 6), the parameter A_{ki} is calculated as follows: | |
| | $A_{ki} = [\sum \{A_m E_m \mu_a(E_m)\}] / [E_k \mu_a(E_k)] \quad (\text{B-37})$ | |
| | The summation in the numerator is over the index m . | |
| A_m | True Photon Yield | [photons per disintegration] |
| | The actual number of photons emitted with energy E_m per decay of nuclide i . | |
| E_m | Photon Energy | [MeV/photon] |
| | The energy of the mth photon within photon energy group k . | |

$\mu_a(E_m)$ Air Energy Absorption Coefficient [m⁻¹]

The linear energy absorption coefficient for air for photon energy E_m .

I(...) I Function

A dimensionless parameter obtained by numerical evaluation of integrals that arise in the plume gamma dose problem. The value of I depends on the arguments (...) listed in Equation B-36. A specific definition for I is given by Equation F-13 of Regulatory Guide 1.109.

The integrals involved in calculating I arise from conceptually dividing up the radioactive plume into small elements of radioactivity and adding up the doses produced at the point of interest by all of the small elements. The distribution of radioactivity in the plume is represented by a sector-averaged Gaussian plume model like that discussed in Section B.2.2.

The parameters R, h_e , u_n , and σ_z are defined in Section B.3.1.

B.5.2 Ground Level Release

The gamma air dose factor G_i for a ground level release is defined as follows:

G_i Gamma Air Dose Factor, Ground Level Release [(mrad/yr)/
(μ Ci/sec)]

The gamma air dose factor at ground level for a ground level release for radionuclide i, downwind sector θ , downwind distance R from the release point, and the average atmospheric conditions of a specified historical time period.

The value of G_i is obtained by the same equation as used for a stack release, Equation B-36 of Section B.5.1, with the following modifications:

- The joint frequency distribution for a ground level release (f_g of Section B.1.2.3) is used in place of the one for a stack release (f_s).
- In evaluating the I function, the effective release height h_e is taken as zero.

This corresponds to use of a finite plume model. This approach differs from that of Regulatory Guide 1.109 in that the regulatory guide has a uniform semi-infinite cloud model to determine dose factors for a ground level release. The approach used here is more realistic than that in the regulatory guide.

B.5.3 Vent Release

For a vent release, the gamma air dose factor is calculated as follows:

$$V_i = [260/(2\pi R/16)] \times \Sigma \{f_{v,elev}(n,\theta,c)[\exp(-\lambda_i R/3600u_n)] \times A_{ki} E_k \mu_a(E_k) I(h_e, u_n, c, \sigma_z, E_k)/u_n + f_{v,ground}(n,\theta,c)[\exp(-\lambda_i R/3600u_n)] \times A_{ki} E_k \mu_a(E_k) I(0, u_n, c, \sigma_z, E_k)/u_n\} \quad (B-38)$$

The summation is over wind speed classes n, atmospheric stability classes c, and photon group indices k

V_i Gamma Air Dose Factor, Vent Release [(mrad/yr)/
(μ Ci/sec)]

The gamma air dose factor at ground level for a vent release for radionuclide i , downwind sector θ , downwind distance R from the release point, and the average atmospheric conditions of a specified historical time period.

The parameters $f_{v,elev}(n,\theta,c)$ and $f_{v,ground}(n,\theta,c)$ are defined in Section B.1.2.4. The parameter S_z is defined in Section B.3.2. The remaining parameters are discussed in Section B.5.1.

B.6 WHOLE BODY DOSE FACTORS ($\bar{S}_i, \bar{V}_i, \bar{G}_i$)

The whole body dose factors provide a simple way of calculating doses and dose rates due to gamma irradiation of the whole body. They are similar to the gamma air dose factors (see the discussion at the beginning of Section B.5). The whole body dose factors are defined for stack, vent, and ground level releases, respectively.

B.6.1 Stack Release

To obtain the whole body dose factor for a stack release, Equation B-36 is modified to account for the attenuation of gamma radiation by 1 cm of tissue with a density of 1 g/m³. The following expression results:

$$\bar{S}_i = [260/(2\pi R/16)] \times \sum \{ f_s(n,\theta,c) [\exp(-\lambda_i R/3600 u_n)] \times A_{ki} E_k \mu_a(E_k) (h_e, u_n, c, \sigma_z, E_k) \times [1/u_n] \exp[-\mu^T_a(E_k) t_d] \} \quad (B-39)$$

The summation is over wind speed classes n , atmospheric stability classes c , and photon group indices k . The change is the addition of the factor $\exp[-\mu^T_a(E_k) t_d]$.

All of the parameters are discussed in Section B.5.1 except the following:

| | | |
|--------------|--|-----------------------------|
| \bar{S}_i | Whole Body Gamma Dose Factor, Stack Release The whole body gamma dose factor at ground level for a stack release for radionuclide i , downwind sector θ , downwind distance R from the release point, and the average atmospheric conditions of a specified historical time period. | [(mrad/yr)/(μ Ci/sec)] |
| $\mu^T(E_k)$ | Tissue Energy Absorption Coefficient The mass energy absorption coefficient for tissue for photon energy group k . The fraction of energy absorbed in tissue per unit distance of travel for a beam of photons of energy E_k with distance measured in units of density thickness (g/cm ²). | [cm ² /g] |
| t_d | Tissue Thickness An assumed value of tissue thickness used in calculating whole body dose. Taken as 1 g/cm ² to represent 1 cm of tissue with a density of 1 g/cm ³ . Accounts for the shielding of the inner more radiosensitive parts of the body by the outer body parts. | [g/cm ²] |

B.6.2 Ground Level Release

The whole body dose factor \bar{G}_i for a ground level release is defined as follows:

| | | |
|-------------|--|-----------------------------|
| \bar{G}_i | Whole Body Gamma Dose Factor, Ground Level Release | [(mrad/yr)/(μ Ci/sec)] |
|-------------|--|-----------------------------|

The whole body gamma dose factor at ground level for a ground level release for radionuclide i , downwind sector θ , downwind distance R from the release point, and the average atmospheric conditions of a specified historical time period.

The equation for \bar{G}_i is obtained from the equation for \bar{S}_i , Equation B-39 of Section B.6.1, by making the two modifications specified in Section B.5.2.

B.6.3 Vent Release

To obtain the whole body dose factor for a vent release, Equation B-38 is modified to account for the attenuation of gamma radiation by 1 cm of tissue with a density of 1 g/cm³. The following expression results.

$$\bar{V}_i = [260/(2\pi R/16)] \times \Sigma \{ [A_{ki} E_k \mu_a(E_k)/u_n] \exp[-\mu_a^T(E_k) t_d] \times [\exp(-\lambda_i R/3600 u_n)] \times [f_{v, elev}(n, \theta, c) I(h_e, u_n, c, \sigma_z, E_k) + f_{v, gnd}(n, \theta, c) I(0, u_n, c, \sigma_z, E_k)] \} \quad (B-40)$$

The summation is over wind speed classes n , atmospheric stability classes c , and photon group indices k .

\bar{V}_i Whole Body Gamma Dose Factor, Vent Release [(mrad/yr)/(μCi/sec)]

The whole body gamma dose factor at ground level for a vent release for radionuclide i , downwind sector θ , downwind distance R from the release point, and the average atmospheric conditions of a specified historical time period.

The parameters $\mu_a^T(E_k)$ and t_d are defined in Section B.6.1. The other parameters are discussed in Section B.5.3.

B.7 BETA AIR AND SKIN DOSE FACTORS (L_i, \bar{L}_i)

The dose factors L_i and \bar{L}_i provide a simple way of calculating beta air and skin doses and dose rates, just as the gamma air dose factors do (see the discussion at the beginning of Section B.5). Their definitions are as follows:

- L_i , discussed in Section A.1.2.2 of Appendix A, is used to calculate beta air dose due to noble gas radionuclide i and has the following units:

$$(\text{mrad/yr}) \text{ per } (\mu\text{Ci}/\text{m}^3)$$

- \bar{L}_i , discussed in Section A.1.2.4 of Appendix A, is used to calculate beta skin dose and dose rate due to noble gas radionuclide i and has the following units:

$$(\text{mrem/yr}) \text{ per } (\mu\text{Ci}/\text{m}^3)$$

The values used in this manual for L_i and \bar{L}_i are specified in Table C-9 of Appendix C and are taken from Regulatory Guide 1.109. The values are based on a semi-infinite cloud model.

B.8 GROUND PLANE DOSE CONVERSION FACTOR DFG_i

The ground plane dose conversion factor DFG_i is used to calculate dose due to standing on ground contaminated with radionuclide i (see Equation A-14 of Appendix A). The units of DFG_i are (mrem/hr) per (pCi/m²).

Values are provided (see Table C-10 of Appendix C) for dose to the whole body. The values are taken from Regulatory Guide 1.109 and are based on a model that assumes a uniformly contaminated ground plane

B.9 INHALATION DOSE COMMITMENT FACTOR DFA_{ija}

The inhalation dose commitment factor DFA_{ija} is used to calculate dose and dose rate to organ j of an individual of age group a due to inhalation of radionuclide i (see Equations A-17 and A-28 of Appendix A).

Values of DFA_{ija} for 10CFR50 compliance are taken from Regulatory Guide 1.109 (Reference 6). The units of DFA_{ija} are (mrem) per (pCi inhaled). Values are provided for seven organs, with the whole body considered as an organ (see Tables E-7, E-8, E-9 and E-10 in Reg. Guide 1.109).

Values of DFA_{ija} used for 10CFR20 compliance assessments are taken from Table 2.1 of reference 93. Evaluations are made for the adult only. The units of DFA_{ija} are (Sv) per (Bq) inhaled.

B.10 INGESTION DOSE COMMITMENT FACTOR DFA_{ija}

The ingestion dose commitment factor DFA_{ija} is used to calculate dose to organ j of an individual of age group a due to ingestion of radionuclide i (see Equation A-18 of Appendix A).

Values of DFA_{ija} for 10CFR50 compliance are taken from Regulatory Guide 1.109 (Reference 6). The units of DFA_{ija} are mrem per pCi ingested. In Tables E-11, E-12, E-13 and E-14 of Reg. Guide 1.109, values are provided for seven organs, with the whole body considered as an organ.

Values of DFA_{ija} used for 10CFR20 compliance assessments are taken from Table 2.2 of reference 93. Evaluations are for the adult only. The units of DFA_{ija} are Sv per Bq ingested.

B.11 MEASURED RELEASE PARAMETERS

Input parameters required for calculations of dose or dose rate due to airborne effluents include measured values of radioactivity release (A_{is} , A_{iv} , and A_{ig}) or release rate (Q_{is} , Q_{iv} , and Q_{ig}) (see Section A.1 of Appendix A). These are obtained per the nuclear power station procedures.

B.12 RADIOLOGICAL DECAY CONSTANTS

Values used for these are obtained from the literature and are specified in Table C-7 of Appendix C.

B.13 PRODUCTION/EXPOSURE PARAMETERS

These parameters characterize various aspects of agricultural production and human exposure. Values used for generic (site-independent) parameters are specified in Appendix C.

Values of site-specific parameters are given in Appendix F. Many of the values are based on Reg. Guide 1.109, while others are based on site-specific considerations.

SECTION 2:

MODELS AND PARAMETERS FOR LIQUID EFFLUENT CALCULATIONS

B.14 INTRODUCTION

Equations for radiation dose and radioactivity concentration due to liquid effluents are given in Section A.2 of Appendix A. The equations involve the following types of parameters:

- Flow and Dilution Parameters.
- Dose Factors.
- Measured Release Parameters.
- Radiological Decay Constants.
- Transport/Consumption Parameters.

This section discusses the methodology used to determine these parameters. Section B.15 addresses dose calculations and Section B.16 addresses concentration calculations for tank discharges. For dose calculations, flow and dilution parameters are discussed for two different models; the River Model, which is used for all nuclear power stations except Zion, and the Lake Michigan Model, which is used for Zion.

B.15 DOSE

B.15.1 Drinking Water

The radiation dose due to consumption of drinking water containing released radioactivity is calculated by Equation A-30 of Appendix A:

$$D_j^{\text{WATER}} = (1.1\text{E-}3)(8760)(U^W_a M^W/F^W) \times \sum \{ A_i DFI_{ija} \exp(-\lambda_i t_w) \} \quad (\text{A-30})$$

The summation is over index *i* (radionuclides) and the parameters are defined in Section A.2.1 of Appendix A.

This equation can be understood as arising from the following model:

- Release of an amount **A** of radioactivity over a time period **T** at a uniform rate **A/T** into a stream flowing at a constant rate **F**. [The resulting radioactivity concentration in the flowing stream is **(A/T)/F**.]
- A fraction of full river flow in which dilution (mixing) occurs is represented by **1/M** (with $1/M \leq 1$)
- The radioactivity decays for a time **t** with decay constant λ .
- Water containing the diluted radioactivity is then consumed at constant rate **U** for a time period **T**.
- The dose commitment per unit of ingested radioactivity is **DFI**.

This model leads to the following equation for dose commitment:

$$D = [(A/T)/F] (M) [\exp(-\lambda t)] (UT) DFI \quad (\text{B-41})$$

$$D = U (M/F) A DFI \exp(-\lambda t) \quad (\text{B-42})$$

Any set of consistent units can be used for the above parameters. For example, the following would be suitable:

| | | |
|------------|-----------------------------------|-----------------|
| A | Released Radioactivity | [pCi] |
| T | Period of Release and Consumption | [hr] |
| F | Dilution Stream Flow Rate | [L/hr] |
| 1/M | Additional Dilution Factor | [dimensionless] |

| | | |
|-----------|----------------------------------|---------------------|
| λ | Decay Constant | [hr ⁻¹] |
| t | Decay Period | [hr] |
| U | Consumption Rate | [L/hr] |
| DFI | Ingestion Dose Commitment Factor | [mrem/pCi] |
| D | Dose Commitment | [mrem] |

In Equation A-30 of Appendix A, units different from the above have been chosen for **A** and **F**:

| | | |
|----------|---------------------------|-------------|
| A | Released Radioactivity | [μ Ci] |
| F | Dilution Stream Flow Rate | [cfs] |

With the modified units, Equation B-42 takes the following form:

$$D = KU (M/F) A DFI \exp(-\lambda t) \quad (B-43)$$

where **K** is a units conversion factor which is expressed as follows:

$$K = [1.1E-3 (\text{pCi/L})(\text{ft}^3/\text{sec})/(\mu\text{Ci/yr})] \times [8760 \text{ hr/yr}] \quad (B-44)$$

B.15.2 Aquatic Foods (Fish)

Near the nuclear power stations, the only aquatic food of significance for human consumption is fish. The radiation dose due to consumption of fish containing released radioactivity is calculated by Equation A-31 of Appendix A:

$$D_{ja}^{\text{Fish}} = (1.1E-3) (8760) (U_a^f M^f / F^f) \times \sum \{A_i B_i DFI_{ija} \exp(-\lambda_i t^f)\} \quad (A-31)$$

The summation is over radionuclides *i*, and the parameters are defined in Section A.2.1 of Appendix A.

The form of this equation is like that used for calculating the dose due to drinking water except for the addition of the bioaccumulation factor, **B_i**. This factor is the equilibrium ratio of the concentration of radionuclide *i* in fish (pCi/kg) to its concentration in water (pCi/L). It accounts for the fact that radioactivity ingested by fish can accumulate in their bodies to a higher concentration than in the waters in which the fish live.

B.15.3 Parameters

B.15.3.1 Flow, Dilution, and Transport Time

The values of dilution flow rate **F**, dilution factor **1/M**, and decay period **t** can differ for water and fish. The dilution and decay parameters for water will depend on where water is drawn, while those for fish will depend on where the fish are caught. Models used to determine these parameters are discussed below. The values used for each station are summarized in Table F-1 of Appendix F.

B.15.3.1.1 River Model

For the purpose of calculating the drinking water dose from liquid effluents discharged into a river, it is assumed that total mixing of the discharge in the river flow (**F^w**) occurs prior to consumption. The measure of dilution used is the parameter **1/M^w** and may be thought of as the fraction of full river flow in which dilution occurs. **1/M^w = 1** represents full dilution. **1/M^w** less than 1 represents dilution in only a portion of the river.

The river flow is taken as the long-term average (generally 10 years). The time period for decay is based on the flow time to the nearest potable water intake on the receiving body of water. This location is described in a footnote to Table F-1 of Appendix F.

For the fish consumption pathway, a near-field dilution flow (F^f) is used. This is an estimate of the dilution of released radioactivity in the water consumed by fish caught near the station downstream of its discharge. No additional dilution is assumed to occur. The decay time between release of radioactivity and its consumption in fish is taken as 24 hours.

B.15.3.1.2 Lake Michigan Model

Only (Zion) discharges liquid effluents into Lake Michigan. For this nuclear power station, it is assumed that the concentration of radioactivity is diluted initially in the condenser cooling water flow (F^c) and then by an additional factor of 60 prior to consumption as potable water (ie; $F^w = F^c / 60$). The dilution factor of 60 is the product of the following:

- Initial entrainment dilution (factor of 10).
- Plume dilution (factor of 3 over approximately 1 mile).
- Current direction frequency (annual average factor of 2).

For the fish ingestion pathway only, it is assumed that radioactivity is diluted in a hypothetical river of flow F^f with dilution $1/M^f = 1.0$. To determine F^f , it was assumed that the near shore lake current constitutes a "river" with the following characteristics:

- Width of 5 miles (based on the observed width of the lake current varying from 2 to 10 miles)
- Depth of 50 feet (the average lake depth from shore out to 5 miles near Zion).
- Flow rate of 0.2 miles per hour (the measured, offshore average value).

This results in $F^f = 4E5$ cfs. The decay time between release of radioactivity and its consumption in fish is taken as 24 hours.

B.15.3.2 Dose Factors

Equations A-30 and A-31 of Appendix A determine dose due to ingested radioactivity using the same ingestion dose factor DFI_{ija} as used in the evaluation of airborne radioactivity which is ingested with foods. The units of DFI_{ija} are:

(mrem) per (pCi ingested)

For 10CFR50 Appendix I compliance, the data of Tables E-1, E-12, E-13 and E-14 of Reg. Guide 1.109 are used for four age groups and for seven organs, with the whole body considered as an organ.

For 10CFR20 compliance, the data of Federal Guidance Report 11 (Reference 93) are used. Data are provided for an adult only, and all organs. Note these data have units of Sieverts per Becquerel ingested and must be multiplied by 3.7×10^9 to convert to units of (mrem) per (μ Ci ingested).

B.15.3.3 Measured Releases

Calculations of dose due to liquid effluents require measured values of radioactivity release (A_i) for input. These release values are obtained per the nuclear power station procedures.

B.15.3.4 Radiological Decay

Values used for these constants are obtained from the literature and are listed in Table C-7 of Appendix C

B.15.3.5 Consumption

Equations A-30 and A-31 of Appendix A involve consumption rates for water and fish (U^w_a and U^f_a). The values used are specified for each nuclear power station in Table F-1 of Appendix F.

B.16 CONCENTRATION IN TANK DISCHARGES

The concentration of radioactivity in a release to the unrestricted area due to a tank discharge is calculated by Equation A-33 of Appendix A:

$$C_i = (C^t_i)(F^r)/(F^d + F^r) \quad (A-33)$$

The parameters are defined in Section A.2.3 of Appendix A.

The radioactivity concentration released from the tank (C^t_i at flow rate F^r) is diluted by mixing with the initial dilution stream (with flow rate F^d) to yield a lower concentration (C_i) in the combined streams.

Table B-1

Portion of an Example Joint Frequency
Distribution

Summary Table of Percent by Direction and Class

| Class | N | NNE | NE | ENE | E | ESE | SE | SSE | S |
|-------|-------|-------|-------|-------|-------|-------|-------|-------|-------|
| A | .289 | .317 | .301 | .244 | .249 | .190 | .198 | .197 | .335 |
| B | .190 | .187 | .178 | .158 | .125 | .065 | .079 | .130 | .193 |
| C | .269 | .226 | .252 | .218 | .190 | .118 | .152 | .189 | .302 |
| D | 3.298 | 2.327 | 2.338 | 2.684 | 1.992 | 1.334 | 1.365 | 2.172 | 3.012 |
| E | 1.466 | 1.198 | .988 | 1.331 | 1.661 | 1.226 | 1.472 | 2.553 | 3.628 |
| F | .504 | .318 | .185 | .276 | .699 | .648 | .803 | 1.293 | 1.732 |
| G | .202 | .091 | .081 | .099 | .253 | .250 | .355 | .400 | .624 |
| Total | 6.217 | 4.663 | 4.304 | 5.011 | 5.169 | 3.830 | 4.424 | 6.933 | 9.826 |

Summary Table of Percent by Direction and Speed

| Speed | N | NNE | NE | ENE | E | ESE | SE | SSE | S |
|-------|-------|-------|-------|-------|-------|-------|-------|-------|-------|
| .45 | .098 | .099 | .078 | .030 | .009 | .000 | .014 | .032 | .046 |
| 1.05 | .308 | .154 | .125 | .137 | .121 | .093 | .090 | .090 | .127 |
| 2.05 | .939 | .602 | .458 | .594 | .843 | .606 | .598 | .605 | 1.008 |
| 3.05 | 1.164 | 1.030 | .779 | .981 | 1.468 | 1.075 | 1.093 | 1.478 | 1.982 |
| 4.05 | 1.179 | 1.024 | .878 | .895 | 1.243 | .831 | 1.027 | 1.727 | 2.110 |
| 5.05 | .839 | .631 | .858 | .798 | .724 | .474 | .652 | 1.254 | 1.636 |
| 6.05 | .612 | .467 | .496 | .589 | .417 | .313 | .418 | .803 | 1.153 |
| 8.05 | .755 | .437 | .612 | .685 | .310 | .313 | .405 | .735 | 1.319 |
| 10.05 | .253 | .157 | .183 | .165 | .032 | .093 | .103 | .180 | .374 |
| 13.05 | .053 | .061 | .034 | .027 | .001 | .031 | .025 | .028 | .072 |
| 18.00 | .016 | .001 | .004 | .000 | .000 | .001 | .001 | .002 | .000 |
| 99.00 | .000 | .000 | .000 | .000 | .000 | .000 | .000 | .000 | .000 |
| Total | 6.217 | 4.663 | 4.304 | 5.011 | 5.169 | 3.830 | 4.424 | 6.933 | 9.826 |

Summary Table of Percent by Speed and Class

| Class Speed | A | B | C | D | E | F | G |
|----------------|------|------|------|-------|-------|-------|-------|
| .45 | .004 | .001 | .000 | .095 | .257 | .275 | .346 |
| 1.05 | .018 | .012 | .027 | .508 | 1.035 | 1.080 | .780 |
| 2.05 | .286 | .171 | .246 | 3.256 | 5.028 | 3.228 | 1.419 |
| 3.05 | .744 | .428 | .616 | 6.258 | 7.173 | 3.272 | .985 |
| 4.05 | .992 | .581 | .781 | 8.165 | 6.404 | 1.902 | .460 |
| 5.05 | .909 | .506 | .808 | 7.302 | 4.357 | .807 | .077 |
| 6.05 | .712 | .388 | .613 | 6.167 | 2.938 | .164 | .013 |
| 8.05 | .819 | .500 | .755 | 7.616 | 2.734 | .081 | .011 |
| 10.05 | .230 | .150 | .196 | 2.606 | .667 | .009 | .000 |
| 13.05 | .075 | .032 | .055 | .755 | .161 | .001 | .000 |
| 18.00 | .004 | .000 | .018 | .117 | .012 | .000 | .000 |
| 99.00 | .000 | .000 | .001 | .001 | .000 | .000 | .000 |

Figure B-1

Instantaneous View of Plume

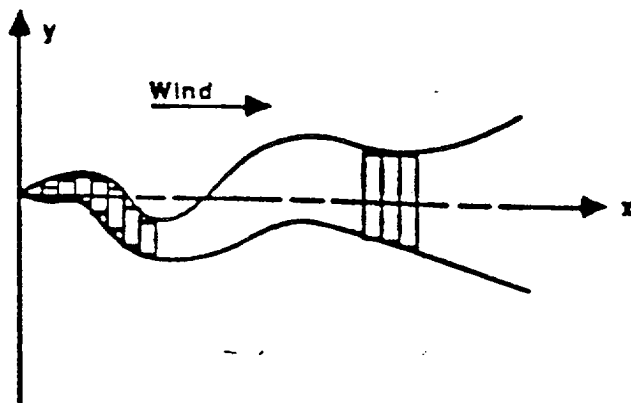

This figure represents a snapshot of a projection of a plume on the horizontal plane. As it moves downwind, the plume both meanders about the average wind direction and broadens (Adapted from Reference 18.)

Figure B-2

A Gaussian Curve

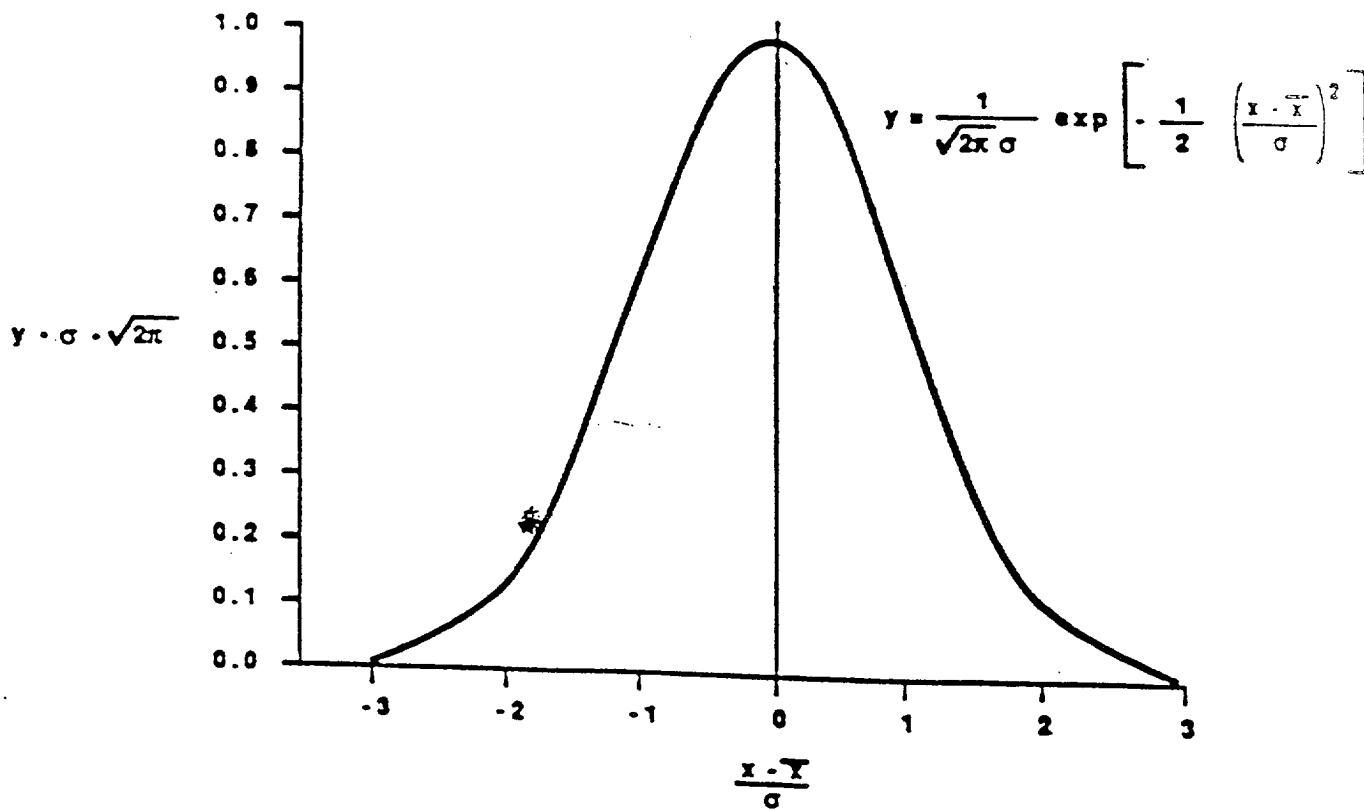

(Adapted from Reference 24 of Chapter 8, Page 61.)

Figure B-3

Effect of Observation Period on Plume Shape

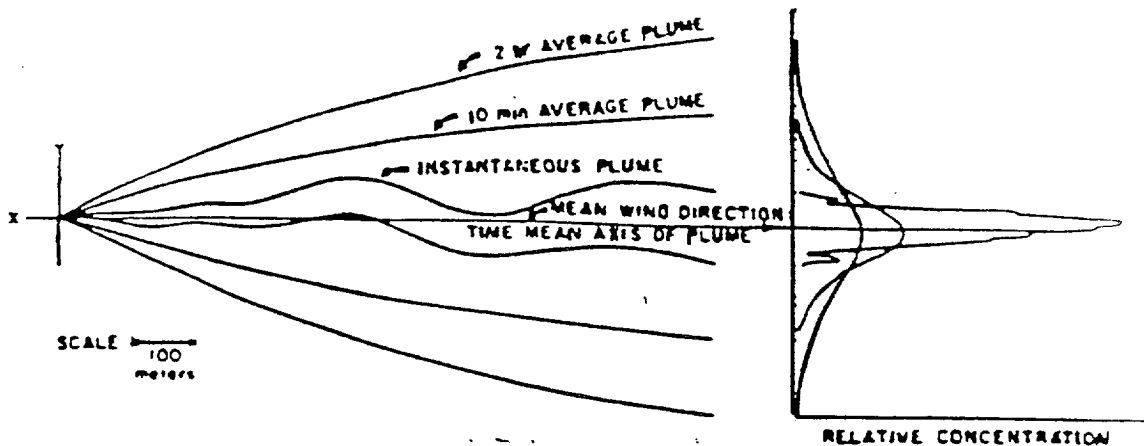

This sketch represents the approximate outlines of a smoke plume observed instantaneously and averaged over periods of 10 minutes and 2 hours. The diagram on the right shows the corresponding cross plume distribution patterns. The plume width increases as the period of observation increases (from Reference 18).

Figure B-4

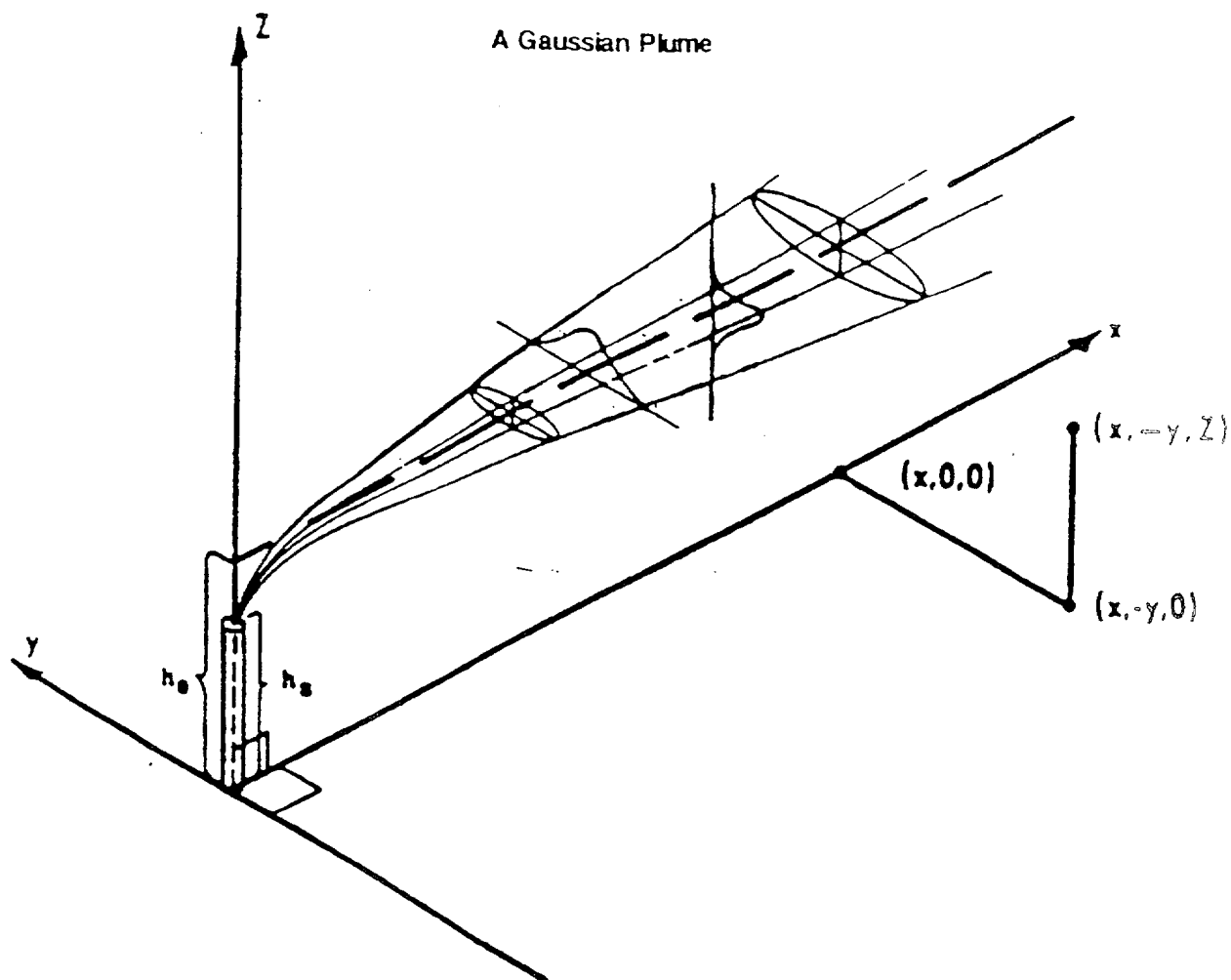

This sketch illustrates a plume characterized by Equation B-9. The plume is moving downwind in the x direction. Both the horizontal dispersion parameter σ_x increase as x increases. The reflected component has been omitted in this illustration (adapted from Reference 24).

Figure B-5

Illustration of Model for Calculation Dose
Due to Radioactivity Release

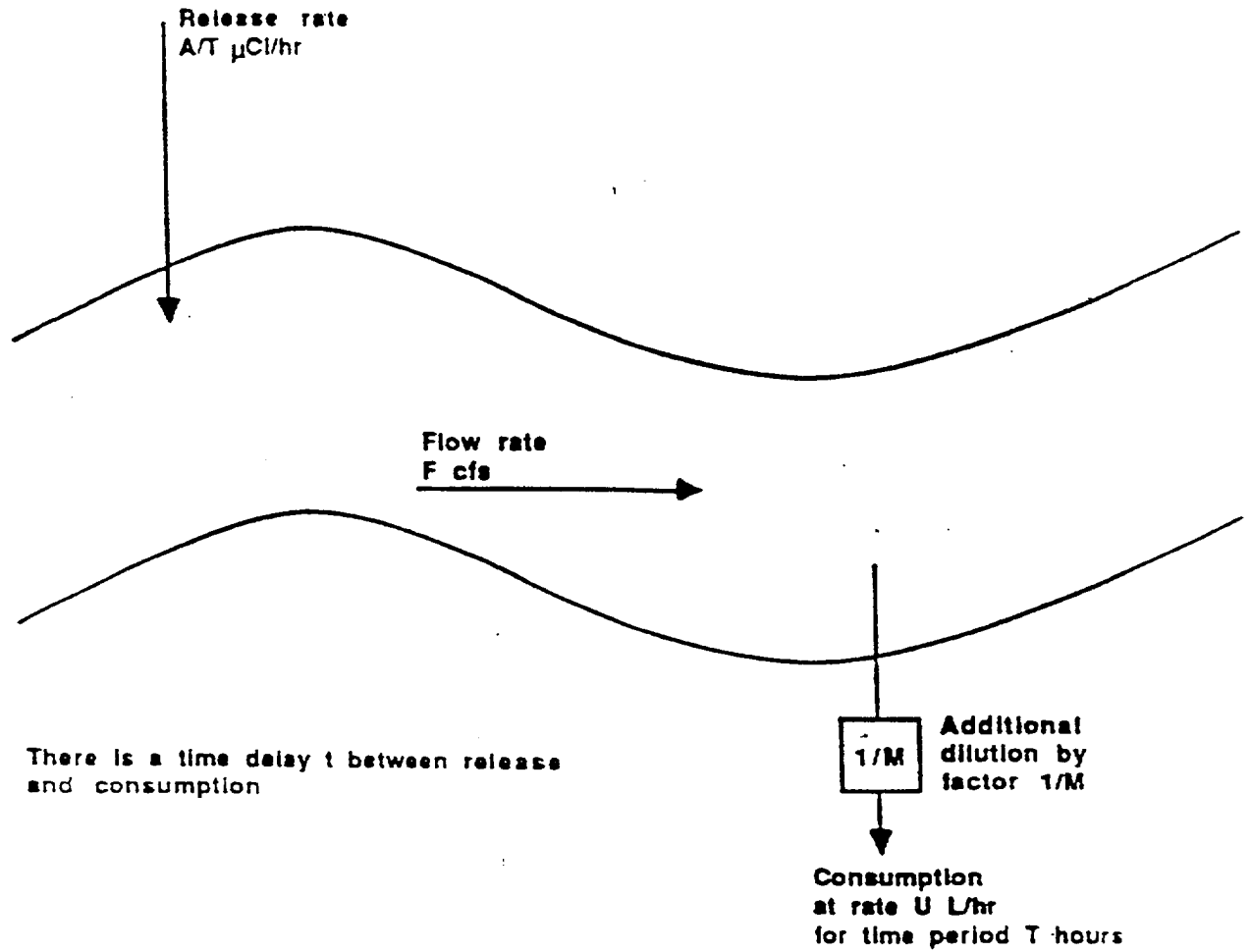

Figure B-6

Illustration of Model for Dilution of
Tank Discharge

