

RADIOACTIVE EFFLUENTS

BASES

3/4.11.2.4 GASEOUS RADWASTE TREATMENT SYSTEM

The OPERABILITY of the WASTE GAS HOLDUP SYSTEM and the PRIMARY PLANT SYSTEM ensures that the systems will be available for use whenever gaseous effluents require treatment prior to release to the environment. The requirement that the appropriate portions of these systems be used, when specified, provides reasonable assurance that the releases of radioactive materials in gaseous effluents will be kept "as low as is reasonably achievable." This control implements the requirements of 10 CFR 50.36a, General Design Criterion 60 of Appendix A to 10 CFR Part 50 and the design objectives given in Section II.D of Appendix I to 10 CFR Part 50. The specified limits governing the use of appropriate portions of the systems were specified as a suitable fraction of the dose design objectives set forth in Sections II.B and II.C of Appendix I, 10 CFR Part 50, for gaseous effluents.

This control applies to the release of radioactive materials in gaseous effluents from each unit at the site. The gaseous effluents from the shared radwaste treatment system are proportioned equally between Unit 1 and Unit 2.

8

3/4.11 RADIOACTIVE EFFLUENTS

BASES (Continued)

3/4.11.4 TOTAL DOSE

This control is provided to meet the dose limitations of 40 CFR Part 190 that have been incorporated into 10 CFR Part 20.1301(d). The control requires the preparation and submittal of a report whenever the calculated doses due to releases of radioactivity and to radiation from uranium fuel cycle sources exceed 25 mremS to the total body or any organ, except the thyroid, which shall be limited to less than or equal to 75 mremS. For sites containing up to four reactors, it is highly unlikely that the resultant dose to a MEMBER OF THE PUBLIC will exceed the dose limits of 40 CFR Part 190 if the individual reactors remain within twice the dose design objectives of Appendix I, and if direct radiation doses from the units (including outside storage tanks, etc.) are kept small. The report will describe a course of action that should result in the limitation of the annual dose to a MEMBER OF THE PUBLIC to within the 40 CFR Part 190 limits. For the purposes of the report, it may be assumed that the dose commitment to the MEMBER OF THE PUBLIC from other uranium fuel cycle sources is negligible, with the exception that dose contributions from other nuclear fuel cycle facilities at the same site or within a radius of 8 km must be considered. If the dose to any MEMBER OF THE PUBLIC is estimated to exceed the requirements of 40 CFR Part 190, the report with a request for a variance (provided the release conditions resulting in violation of 40 CFR Part 190 have not already been corrected), in accordance with the provisions of 40 CFR 190.11 and 10 CFR 20.2203(a)(4) and 20.2203(b), is considered to be a timely request and fulfills the requirements of 40 CFR Part 190 until NRC staff action is completed. The variance only relates to the limits of 40 CFR Part 190, and does not apply in any way to the other requirements for dose limitation of 10 CFR Part 20, as addressed in Controls 3.11.1.1 and 3.11.2.1. An individual is not considered a MEMBER OF THE PUBLIC during any period in which he/she is engaged in carrying out any operation that is part of the nuclear fuel cycle. Demonstration of compliance with the limits of 40 CFR Part 190 or with the design objectives of Appendix I to 10 CFR Part 50 will be considered to demonstrate compliance with the 0.1 rem limit of 10 CFR 20.1301.

12
16

16

12

BASES

3/4.12.1 MONITORING PROGRAM

The Radiological Environmental Monitoring Program required by this control provides representative measurements of radiation and of radioactive materials in those exposure pathways and for those radionuclides that lead to the highest potential radiation exposure of MEMBERS OF THE PUBLIC resulting from the plant operation. This monitoring program implements Section IV.B.2 of Appendix I to 10 CFR Part 50 and thereby supplements the Radiological Effluent Monitoring Program by verifying that the measurable concentrations of radioactive materials and levels of radiation are not higher than expected on the basis of the effluent measurements and the modeling of the environmental exposure pathways. Guidance for this monitoring program is provided by the Radiological Assessment Branch Technical Position on Environmental Monitoring, Revision 1, November 1979. The initially specified monitoring program will be effective for at least the first 3 years of commercial operation. Following this period, program changes may be initiated based on operational experience.

The required detection capabilities for environmental sample analyses are tabulated in terms of the lower limits of detection (LLDs). The LLDs required by Table 4.12-1 are considered optimum for routine environmental measurements in industrial laboratories. It should be recognized that the LLD is defined as an a priori (before the fact) limit representing the capability of a measurement system and not as an a posteriori (after the fact) limit for a particular measurement.

Detailed discussion of the LLD, and other detection limits, can be found in Currie, L. A., "Lower Limit of Detection: Definition and Elaboration of a Proposed Position for Radiological Effluent and Environmental Measurements," NUREG/CR-4007 (September 1984), and in the HASL Procedures Manual, HASL-300.

3/4.12.2 LAND USE CENSUS

This control is provided to ensure that changes in the use of areas at or beyond the SITE BOUNDARY are identified and that modifications to the Radiological Environmental Monitoring Program are made if required by the results of this census. The best information from the door-to-door survey, from aerial survey or from consulting with local agricultural authorities shall be used. This census satisfies the requirements of Section IV.B.3 of Appendix I to 10 CFR Part 50. Restricting the census to gardens of greater than 50 m² provides assurance that significant exposure pathways via leafy vegetables will be identified and monitored since a garden of this size is the minimum required to produce the quantity (26 kg/year) of leafy vegetables assumed in Regulatory Guide 1.109 for consumption by a child. To determine this minimum garden size, the following assumptions were made: (1) 20% of the garden was used for growing broad leaf vegetation (i.e., similar to lettuce and cabbage), and (2) a vegetation yield of 2 kg/m².

12

RADIOLOGICAL ENVIRONMENTAL MONITORING

BASES

3/4.12.3 INTERLABORATORY COMPARISON PROGRAM

The requirement for participation in an approved Interlaboratory Comparison Program is provided to ensure that independent checks on the precision and accuracy of the measurements of radioactive materials in environmental sample matrices are performed as part of the quality assurance program for environmental monitoring in order to demonstrate that the results are valid for the purposes of Section IV.B.2 of Appendix I to 10 CFR Part 50.

SECTION 5.0
DESIGN FEATURES

MAP DEFINING CONTROLLED AREAS, UNRESTRICTED AREAS AND SITE BOUNDARY
FOR RADIOACTIVE GASEOUS AND LIQUID EFFLUENTS

8

5.1.3 Information regarding radioactive gaseous and liquid effluents, which allows identification of structures and release points as well as definition of CONTROLLED AREAS, UNRESTRICTED AREAS and the SITE BOUNDARY are shown in Figure 5.1-3.

The UNRESTRICTED AREA, as shown in Figure 5.1-3, is that area beyond the SITE BOUNDARY. Access to this area is not limited or controlled by the licensee. This is consistent with the definition of UNRESTRICTED AREA given in 10 CFR 20.1003. The SITE BOUNDARY coincides with the Exclusion (fenced) Area Boundary, as defined in 10 CFR 100.3(a). For calculations performed pursuant to 10 CFR 50.36a, the concept of UNRESTRICTED AREAS, established at or beyond the SITE BOUNDARY, is utilized in the Controls to keep levels of radioactive materials in liquid and gaseous effluents as low as is reasonably achievable.

12

The CONTROLLED AREA, as shown in Figure 5.1-3, is that area that is inside the SITE BOUNDARY but is outside of any plant areas defined by the licensee as restricted areas, per the definition of restricted area in 10 CFR 20.1003. Access to the CONTROLLED AREA is limited or controlled by the licensee. This is consistent with the definition of CONTROLLED AREA given in 10 CFR 20.1003.

8

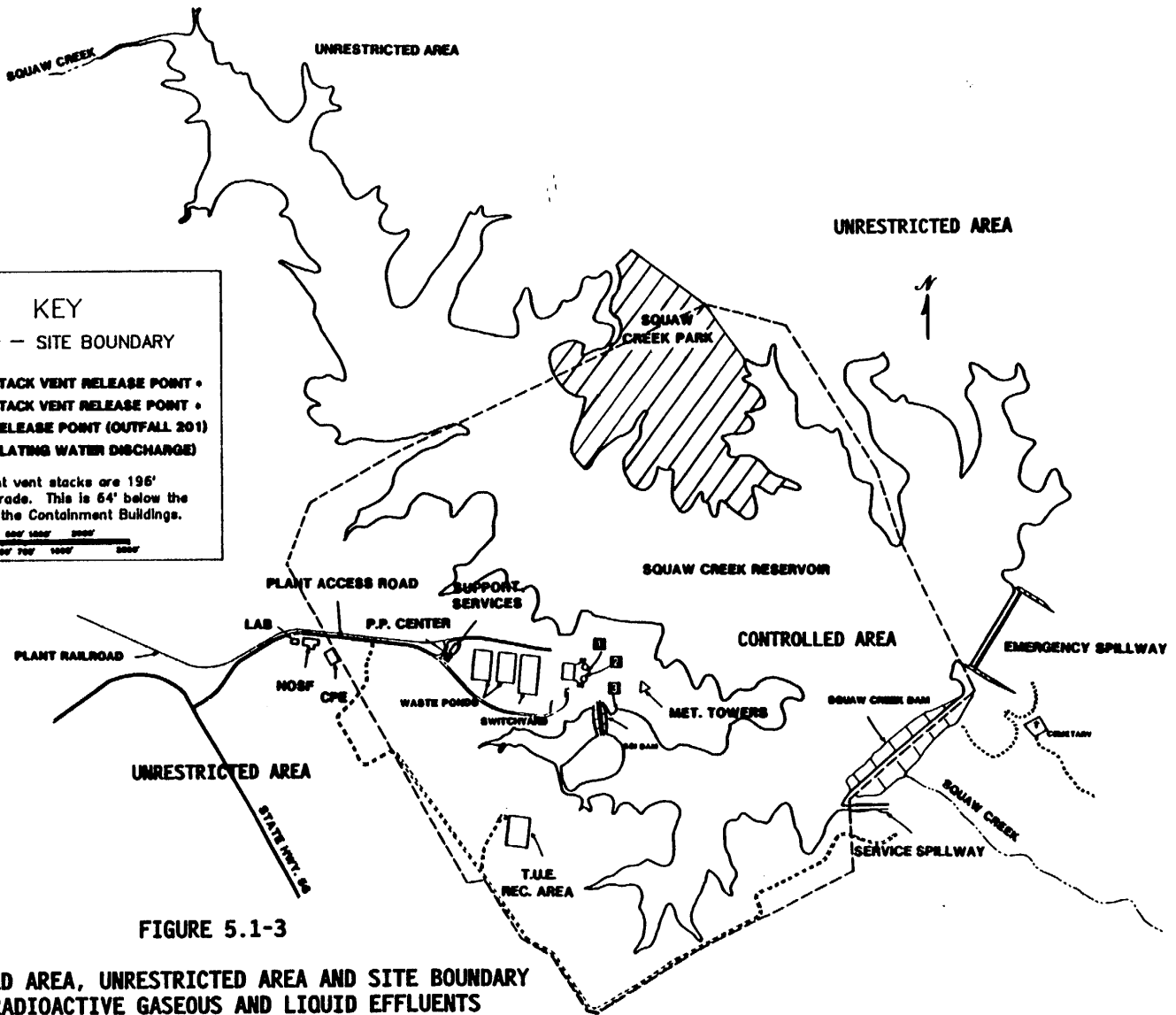
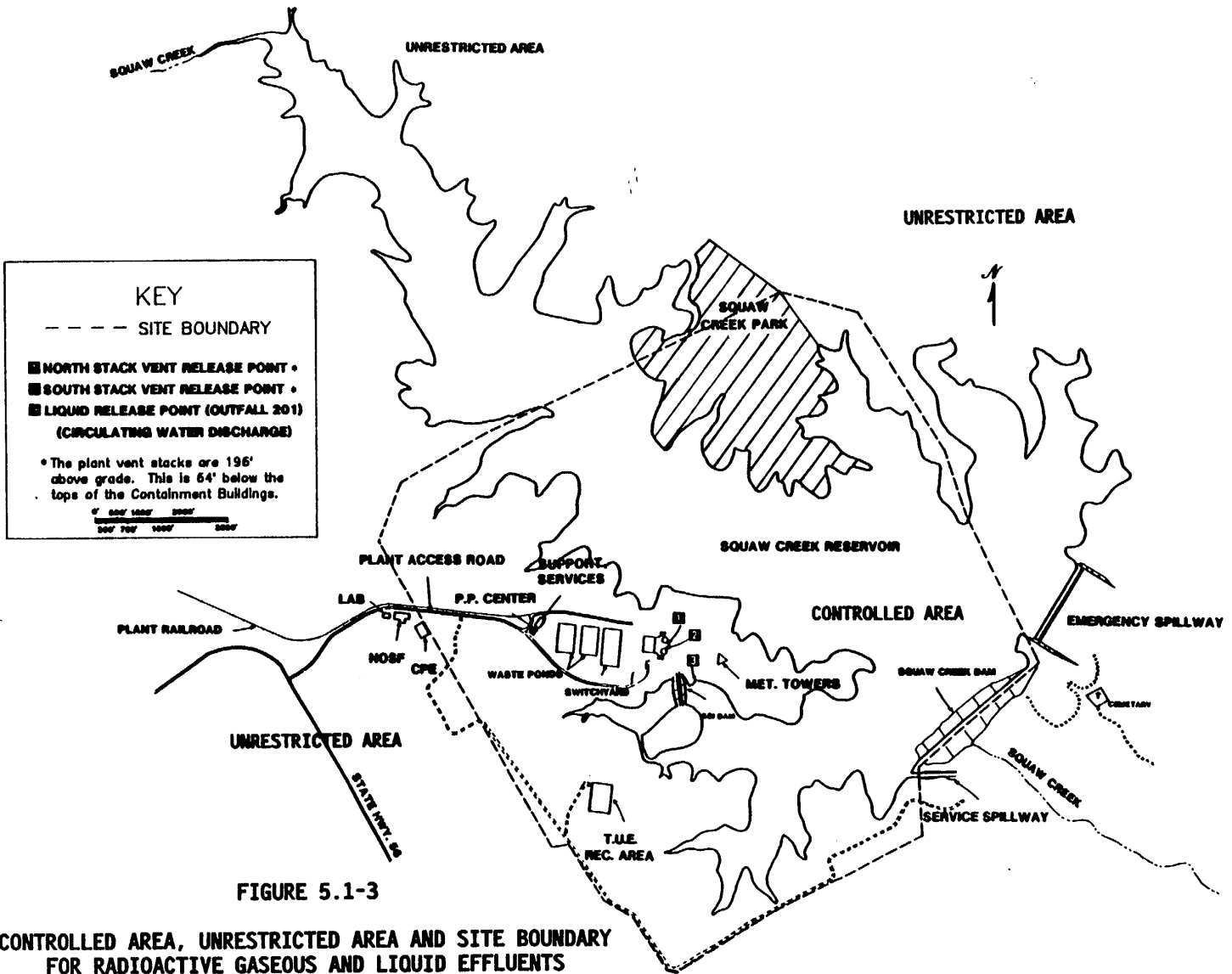

SECTION 6.0
ADMINISTRATIVE CONTROLS

ANNUAL RADIOLOGICAL ENVIRONMENTAL OPERATING REPORT*

6.9.1.3 A Routine Annual Radiological Environmental Operating Report covering the operation of the units during the previous calendar year shall be submitted prior to May 1 of each year.

8

The Annual Radiological Environmental Operating Report shall include summaries, interpretations, and an analysis of trends of the results of the radiological environmental surveillance activities for the report period, including a comparison with preoperational studies and with operational controls, as appropriate, and with previous environmental surveillance reports, and an assessment of the observed impacts of the plant operation on the environment. The report shall also include the results of the annual Land Use Census required by Control 3.12.2.

12

The Annual Radiological Environmental Operating Report shall include the results of analysis of all radiological environmental samples and of all environmental radiation measurements taken during the period pursuant to the locations listed and maintained current in the results of the annual Land Use Census, as well as summarized and tabulated results of these analyses and measurements in the format of the table in the Radiological Assessment Branch Technical Position, Revision 1, November 1979. In the event that some individual results are not available for inclusion with the report, the report shall be submitted noting and explaining the reasons for the missing results. The missing data shall be submitted as soon as possible in a supplementary report.

12

The Annual Radiological Environmental Operating Report shall also include the following: a summary description of the Radiological Environmental Monitoring Program; at least two legible maps** covering all sampling locations keyed to a table giving distances and directions from the centerline of one reactor; the results of participation in the Interlaboratory Comparison Program and the corrective action taken if the specified program is not being performed as required by Control 3.12.3; reasons for not conducting the Radiological Environmental Monitoring Program as required by Control 3.12.1, and discussion of all deviations from the sampling schedule of Table 3.12-1; discussion of environmental sample measurements that exceed the reporting levels of Table 3.12-1; and discussion of all analyses in which the LLD required by Table 4.12-1 was not achievable.

12

* A single submittal may be made for both units.

8

** One map shall cover stations near the SITE BOUNDARY; a second shall include the more distant stations. Maps are included in the results of the annual Land Use Census.

12

RADIOACTIVE EFFLUENT RELEASE REPORT*

16

6.9.1.4 A routine Radioactive Effluent Release Report covering the operation of the units during the previous year of operation shall be submitted prior to May 1 of each year. The period of the first report shall begin with the date of initial criticality.

16

The Radioactive Effluent Release Report shall include a summary of the quantities of radioactive liquid and gaseous effluents and solid waste released from the unit as outlined in Regulatory Guide 1.21, "Measuring, Evaluating, and Reporting Radioactivity in Solid Wastes and Releases of Radioactive Materials in Liquid and Gaseous Effluents from Light-Water-Cooled Nuclear Power Plants," Revision 1, June 1974, with data summarized on a quarterly basis following the format of Appendix B thereof. For solid wastes, the format for Table 3 in Appendix B shall be supplemented with three additional categories: class of solid wastes (as defined by 10 CFR Part 61), type of container (e.g., LSA, Type A, Type B, Large Quantity) and SOLIDIFICATION agent or absorbent (e.g., cement, urea formaldehyde).

16

The Radioactive Effluent Release Report shall include an annual summary of hourly meteorological data collected over the previous year. This annual summary may be either in the form of an hour-by-hour listing on magnetic tape of wind speed, wind direction, atmospheric stability, and precipitation (if measured), or in the form of joint frequency distributions of wind speed, wind direction, and atmospheric stability.** This same report shall include an assessment of the radiation doses due to the radioactive liquid and gaseous effluents released from the unit or station during the previous calendar year. This same report shall also include an assessment of the radiation doses from radioactive liquid and gaseous effluents to MEMBERS OF THE PUBLIC due to their activities inside the SITE BOUNDARY (Figure 5.1-3) during the report period. All assumptions used in making these assessments, i.e., specific activity, exposure time, and location, shall be included in these reports. Historical average meteorological conditions or the meteorological conditions concurrent with the time of release of radioactive materials in gaseous effluents, as determined by sampling frequency and measurement, shall be used for determining the gaseous pathway doses. The assessment of radiation doses shall be performed in accordance with the methodology and parameters in Part II of the OFFSITE DOSE CALCULATION MANUAL (ODCM).

16

8

* A single submittal may be made for both units. The submittal should combine those sections that are common to both units at the station.

12

** In lieu of submission with the Radioactive Effluent Release Report, the licensee has the option of retaining this summary of required meteorological data on site in a file that shall be provided to the NRC upon request.

16

RADIOACTIVE EFFLUENT RELEASE REPORT (Continued)

16

The Radioactive Effluent Release Report shall also include an assessment of radiation doses to the likely most exposed MEMBER OF THE PUBLIC from reactor releases and other nearby uranium fuel cycle sources, including doses from primary effluent pathways and direct radiation, for the previous calendar year to show conformance with 40 CFR Part 190, "Environmental Radiation Protection Standards for Nuclear Power Operation." Acceptable methods for calculating the dose contribution from liquid and gaseous effluents are given in Regulatory Guide 1.109, Rev. 8, October 1977.

16

The Radioactive Effluent Release Report shall include a list and description of unplanned releases, from the site to CONTROLLED AREAS and UNRESTRICTED AREAS, of radioactive materials in gaseous and liquid effluents made during the reporting period.

16

The Radioactive Effluent Release Report shall include a listing of new locations for dose calculations and/or environmental monitoring identified by the Land Use Census pursuant to Control 3.12.2.

16

The Radioactive Effluent Release Report shall also include the following: an explanation as to why the inoperability of liquid or gaseous effluent monitoring instrumentation was not corrected within the time specified in Controls 3.3.3.4 or 3.3.3.5, respectively; and a description of the events leading to liquid holdup tanks or gas storage tanks exceeding the Technical Specification limits.

16

6.14 OFFSITE DOSE CALCULATION MANUAL (ODCM)

Changes to the ODCM:

a. Shall be documented and records of reviews performed shall be retained as required by FSAR Section 17.2.17.1.3. This documentation shall contain:

16

1) Sufficient information to support the change together with the appropriate analyses or evaluations justifying the change(s) and

2) A determination that the change will maintain the level of radioactive effluent control required by 10 CFR 20.1302, 40 CFR Part 190, 10 CFR 50.36a, and Appendix I to 10 CFR Part 50 and not adversely impact the accuracy or reliability of effluent, dose, or setpoint calculations.

8

b. Shall become effective after review and acceptance by the SORC and the approval of the Vice President of Nuclear Operations.

1
9

6.14 OFFSITE DOSE CALCULATION MANUAL (ODCM) (Continued)

- c. Shall be submitted to the Commission in the form of a complete, legible copy of the entire ODCM as a part of or concurrent with the Radioactive Effluent Release Report for the period of the report in which any change to the ODCM was made. Each change shall be identified by markings in the margin of the affected pages, clearly indicating the area of the page that was changed, and shall indicate the date (e.g., month/year) the change was implemented.

16

PART II

CALCULATIONAL METHODOLOGIES

SECTION 1.0
LIQUID EFFLUENTS

The Comanche Peak Steam Electric Station (CPSES) is a 2-unit nuclear generating facility. Each unit is a 1150 MWe, 4-loop, Westinghouse PWR. The units share a common primary liquid radwaste processing system. CPSES is located on Squaw Creek Reservoir (SCR), which serves as the point of supply and discharge for the plant circulating water. Radioactive liquid effluent releases from the primary radwaste processing system are batch type releases, from the Plant Effluent Tanks (PET), Laundry Holdup & Monitor Tanks (LHMT) and Waste Monitor Tanks (WMT), discharged to SCR via the Circulating Water Discharge Tunnel. Potentially radioactive liquid effluent releases from secondary systems include a continuous release from the Turbine Building Sumps (TB Sump), the Unit 1 and Unit 2 Component Cooling Water Drain Tanks (CCWDT), Auxiliary Building Sumps 3 and 11, the Unit 1 and Unit 2 Diesel Generator Sumps 1 and 2, and batch releases from the Condensate Polisher Backwash Recovery Tanks (CPBWRT) and temporary hold up tanks. These secondary pathways from each unit are normally discharged to the common Low Volume Waste (LVW) Pond for chemical treatment. The LVW Pond normally discharges to SCR via the circulating Water Discharge Tunnel. Alternatively, secondary waste streams may be routed to the common Waste Water Holdup Tanks (WWHT) or other parts of the Waste Water Management System. The WWHTs may be released on a batch basis to the LVW Pond or to SCR via the Circulating Water Discharge Tunnel, depending on the levels of radioactivity present. Table 4.11-1 of Part I of this document requires that secondary waste streams be diverted to the WWHT's if radioactivity is present in the waste stream in concentrations that exceed 10 times the limits of 10 CFR 20, Appendix B, Table 2, Column 2. Also, releases from the Station Service Water (SSW) System are monitored for radioactivity, although no significant releases of radioactivity are expected from this pathway. Sampling and analysis requirements for all release sources are given in Part I, Table 4.11-1. All batch release sources are isolated and thoroughly mixed by mechanical mixing or recirculating the tank contents, prior to sampling, to assure representative sampling. The recirculation or mixing times necessary to assure representative sampling shall be specified in station procedures.

8

7A

7

9

14

8

14

7

12

8

A summary of all liquid effluent release sources, volumes, flow rates, and associated radiation monitors is shown in Table 1.1. A flow diagram of all liquid effluent discharge pathways is shown in Figure 1.1.

7

The liquid effluent radiation monitors shown in Figure 1.1 are part of the plant Digital Radiation Monitoring System (DRMS) supplied by Sorrento Electronics (formerly General Atomics). Since the DRMS monitors provide a digital output, they may be calibrated to read out in the appropriate engineering units (i.e., uCi/ml). The conversion factor for detector output from counts per minute to uCi/ml is determined in the calibration process and input into the database for the monitor microprocessor.

1.1 10 CFR 20 AND RADIOLOGICAL EFFLUENT CONTROL 3/4.11.1.1 COMPLIANCE

8

To demonstrate compliance with 10 CFR 20.1301, ODCM Radiological Effluent Control 3/4.11.1.1 requires that the concentration of radioactive material released in liquid effluents to CONTROLLED AREAS and UNRESTRICTED AREAS be limited to 10 times the concentrations specified in 10 CFR 20, Appendix B, Table 2, Column 2, for radionuclides other than dissolved or entrained noble gases, and to 2E-4 uCi/ml for dissolved or entrained noble gases. 10 CFR 20 compliance is checked for all discharges to SCR via the Circulating Water Discharge Tunnel listed in Table 1.1. Because the LVW Pond is located in a CONTROLLED AREA, discharges to the LVW Pond are also checked for 10 CFR 20 compliance. If radioactive materials are present in the LVW Pond discharge in concentrations that exceed 10% of the limits of 10 CFR 20, Appendix B, Table 2, Column 2, then all inputs to the LVW Pond are sampled and checked for compliance with 10 CFR 20. The following methodology is used to determine compliance with these limits.

12

7

8

8

7

1.1.1 Isotopic Concentration of the Waste Tank

Determine the isotopic concentration in waste stream to be released:

$$\sum_i C_i = \sum_g C_g + (C_a + C_s + C_t + C_{Fe}) \quad [\text{Eq 1-1}]$$

Where: $\sum_i C_i$ = Sum of the concentrations of each radionuclide, in the release (uCi/ml) | 7

$\sum_g C_g$ = Sum of the concentrations of each measured gamma emitter, g, (uCi/ml) as required by Radiological Effluent Control 3/4.11.1.1, Table 4.11-1.

C_a = Concentration of alpha emitters as measured in the most recent composite sample (uCi/ml) required by Radiological Effluent Control 3/4.11.1.1, Table 4.11-1. (Sample analyzed for gross alpha only) | 7

C_s = Concentration of ^{89}Sr and ^{90}Sr as measured in the most recent composite sample (uCi/ml) required by Radiological Effluent Control 3/4.11.1.1, Table 4.11-1. | 7

C_t = Concentration of ^3H as measured in the most recent composite sample (uCi/ml) required by Radiological Effluent Control 3/4.11.1.1, Table 4.11-1. | 7

C_{Fe} = Concentration of ^{55}Fe as measured in the most recent composite sample (uCi/ml) required by Radiological Effluent Control 3/4.11.1.1, Table 4.11-1. | 7

1.1.2 Effluent Flow Rate (f)

The maximum effluent discharge flow rates for each release source are shown in Table 1.1. For pre-release calculations, the maximum effluent flow rate is normally used. For post-release calculations, the average effluent flow rate during the release may be used. When the maximum effluent flow rate is used for pre-release calculations, no setpoint is required for the flow measuring device for the effluent release line. If a lower effluent flow rate is used in pre-release calculations, a flow measuring device setpoint shall be established to ensure that the ratio of the Required | 7
| 8
| 8

Dilution Factor (RDF) to the Actual Dilution Factor (ADF) is maintained less than or equal to 1.0, as discussed in Section 1.1.6. ADF and RDF are defined in Section 1.1.4 and 1.1.5, respectively.

8

1.1.3 Dilution of Liquid Effluents

a. Discharges to SCR via Circulating Water Discharge Tunnel

7

Since liquid effluents from the radwaste treatment system, Waste Water Holdup Tanks and the LVW Pond are mixed with Circulating water prior to being discharged to Squaw Creek Reservoir, compliance with 10 CFR 20 is a function of the Circulating water flow rate. The maximum Circulating water flow rate per plant is 1.1 million gpm. This is determined from the Ingersoll-Rand pump curves (Fig. 1.2) which indicate a flow rate per pump of 275,000 gpm. The actual Circulating water dilution flow is given by:

7

$$F(\text{diluting flow}) = (275,000 \text{ gpm/pump}) \times (\# \text{ of pumps}) \times 0.9$$

[Eq. 1-2]

Where: 0.9 = Safety Factor to compensate for flow fluctuations from the rate predicted by the Circulating water pump curves (Fig. 1.2).

As an additional consideration, the available dilution flow for any release may be corrected to allow for simultaneous releases from the Radwaste Processing System, a Waste Water Holdup Tank, and/or the LVW Pond (i.e., a radwaste system tank, a Waste Water Holdup Tank, and the LVW Pond may be discharged simultaneously). For simultaneous releases, the available dilution flow for any release is reduced by the required dilution flow for any other concurrent releases. Also, the reservoir into which the diluted radwaste flows may build up a concentration of radioactive isotopes. It is therefore necessary to account for recirculation of previously discharged radionuclides. This is accomplished as follows:

$$F' = F (1 - \sum_i (C'_i/10ECL_i))$$

[Eq. 1-3]

12

Where: F' = Adjusted Circulating Water Flow Rate
 C'_i = Maximum concentration of radionuclide i in Squaw Creek Reservoir (uCi/ml) as measured in the analysis of the monthly samples of the reservoir required by Radiological Effluent Control 3/4.12.1, Table 3.12.1. Sample locations are listed and maintained current in the results of the annual Land Use Census.

ECL_i = Effluent Concentration Limit of radionuclide i , from 10CFR20, Appendix B, Table 2, Column 2

F = (275,000 gpm/pump) x (# or pumps) x 0.9

NOTE: If C'_i is less than LLD then $F' = F$ and no adjusted flow rate need be considered in the calculation of ADF. The LLD values used for this determination shall be the LLD values for water given in Radiological Effluent Control 3/4.12.1, Table 4.12-1.

b. Discharges to the LVW Pond

Secondary release sources are discharged directly to the LVW Pond with no dilution (i.e., $F=0$).

1.1.4 Actual Dilution Factor (ADF)

ADF is the ratio of the effluent flow rate plus the Circulating water flow rate divided by the effluent flow rate.

$$ADF = (f + F)/f \quad [\text{Eq. 1-4}]$$

Where: f = Effluent flow rate (gpm)

F = Dilution flow rate (gpm)

NOTE: If radioactivity is detected in the Reservoir, an adjusted Circulating water flow rate, F' , shall be used in place of F in the calculation of ADF. See Section 1.1.3 for the calculation of F' (Eq. 1-3). Also, if simultaneous releases are occurring, the available dilution flow shall be reduced by the required dilution flow for any other concurrent release.

1.1.5 Required Dilution Factor (RDF)

The required dilution factor ensures that the limits of Control 3/4.11.1.1 (i.e., 10 times the effluent concentrations expressed in 10CFR20, Appendix B, Table 2, Column 2, and a total concentration of dissolved or entrained noble gases of 2×10^{-4} uCi/ml) are not exceeded during a discharge. The required dilution factor includes a safety factor of 2 to provide a margin of assurance that the instantaneous concentration limits are not exceeded.

12

$$\begin{aligned}
RDF &= (\sum_i (C_i/10ECL_i)) \times SF \\
&= (\sum_g (C_g/10ECL_g) + (C_a/10ECL_a + C_s/10ECL_s + \\
&\quad C_t/10ECL_t + C_{fe}/10ECL_{fe})) \times SF
\end{aligned}$$

[Eq. 1-5]

12

Where: ECL_i = Effluent Concentration Limit of radionuclide i, from 10CFR20, Appendix B, Table 2, Column 2

SF = Safety Factor of 2.

8

7

All other variables and subscripts are previously defined.

NOTE: If RDF is less than 1, the release meets discharge limits without dilution. For conservatism, set RDF equal to 1.0. The maximum value for the high alarm setpoint for detector XRE-5253 would then be calculated in accordance with the equation for C_{1w} in Section 1.2.1.

7

1.1.6 10 CFR 20 Compliance

Compliance with 10 CFR 20 is demonstrated if the Actual Dilution Factor (ADF) is greater than or equal to the Required Dilution Factor (RDF).
or:

7

$$\frac{RDF}{ADF} \leq 1.0$$

[Eq. 1-6]

7

1.2 RADIATION MONITOR ALARM SETPOINTS | 7

1.2.1 Primary Liquid Effluent Monitor XRE-5253 | 7

To ensure that releases from the primary radwaste processing system do not exceed 10 times the 10 CFR 20, Appendix B, Table 2, Column 2 limits at the point of release to the CONTROLLED AREA or UNRESTRICTED AREA, a radiation detector (XRE-5253) monitors discharges to the Circulating Water Discharge Tunnel. XRV-5253 is the discharge isolation valve controlled by XRE-5253. The isolation valve shuts automatically if the detector alarms on high radiation or a detector operation failure occurs. It should be noted that the liquid effluent monitor setpoint values determined using the methodology from this section will be regarded as upper bounds for the actual setpoint adjustments. That is, setpoints may be established at values lower than the calculated values, if desired. Further, if the calculated value should exceed the maximum range of the monitor, the setpoint shall be adjusted to a value that falls within the normal operating range of the monitor. | 12
7
10
7

Since the radiation monitor XRE-5253 is a gamma sensitive device, the monitor setpoint value shall be set based on the gamma radionuclides present in the waste stream. Therefore, a Required Dilution Factor gamma (RDF_g) must be determined before the setpoint can be calculated. | 10

$$RDF_g = \sum (C_g/10ECL_g) \times SF \quad [Eq. 1-6a] \quad | 12$$

Where: RDF_g = The required dilution factor (gamma) corresponding to the gamma concentration in the undiluted waste stream ensuring that 10 times the effluent concentration limits in 10CFR20, Appendix B, Table 2, Column 2 are not exceeded at the point of release during a discharge. If RDF_g is less than 1, set RDF_g equal to 1.0.

SF = A required safety factor of 2 is used to account for the presence of Tritium, composited Alpha emitters, Fe-55, Sr-89 and Sr-90 values which are undetectable by this monitor and are at or near equilibrium and/or not expected to change rapidly under most plant conditions and statistical errors of measurement. | 10

The monitor XRE-5253 setpoint is determined using the following calculation:

10

$$C_{1w} = (ADF/RDF_g) \times \sum_g C_g \quad [\text{Eq. 1-7}]$$

Where: C_{1w} = The liquid waste effluent monitor alarm setpoint. This corresponds to the gamma concentration in the undiluted waste stream which after dilution would result in a release at the limits of Control 3.11.1.1.

12

All other variables are as previously defined.

7

When considering the mixture of nuclides in the liquid effluent stream in terms of detector sensitivity, the most probable nuclides present would be those referenced in Radiological Effluent Control 3/4.11.1.1, Table 4.11-1, Table Notation 2. Figure 1.3 is a representative energy spectrum response for the RD-33 type detector used in XRE-5253. This curve illustrates that for any given mixture of the most probable gamma emitting nuclides present, the conversion factor between counts per minute and microcuries per milliliter remains relatively constant. In fact between ^{137}Cs and ^{60}Co , the total change in sensitivity is approximately 7%. Because this is well within the accuracy of measurement, there is no need to change the software sensitivity for given varied effluent concentrations. However, should the concentration of previously unexpected nuclides become significant, further evaluation would be required.

1.2.2 Turbine Building Sump Effluent Radiation Monitor 1RE-5100 and 2RE-5100

8

The purpose of the turbine building sump monitor (1RE-5100 and 2RE-5100) is to monitor turbine building sump discharges and divert this discharge from the Low Volume Waste Pond to the Waste Water Holdup Tanks if radioactivity is detected. Because the only sources of water to the turbine building sump are from the secondary steam system, activity is expected only if a significant primary-to-secondary leak is present. Since detectable radioactivity is not normally present in the Turbine Building Sumps, the monitor setpoint should be established as close to background as practical to prevent spurious alarms and yet alarm, should an inadvertent

7

8

radioactive release occur. To this end, the setpoint will be initially established at three (3) times background until further data can be collected. Then, if this setpoint is exceeded, the monitor will direct control valves to divert the turbine building sumps discharges from the LVW Pond to the Waste Water Holdup Tanks where the effluent can then be sampled and released in a batch mode to Squaw Creek Reservoir, if required by Radiological Effluent Control 3/4.11.1.1, Table 4.11-1. When radioactive materials are detected in the Turbine Building Sumps, a setpoint then may be established for 1RE-5100 or 2RE-5100 using the methodology in Section 1.2.1 to ensure that the limits of Control 3.11.1.1 are not exceeded in discharges to the LVW Pond.

8
7
8
7
12

1.2.3 Station Service Water (SSW) Effluent Radiation Monitors 1RE-4269/4270 and 2RE-4269/4270

15

The concentration of byproduct radioactive materials released from plant operations to the station service water (SSW) effluent lines normally is expected to be insignificant. However, because the SSW effluent has no additional dilution prior to its release into Squaw Creek Reservoir, it is important that this stream's process radiation monitors be optimized to detect any potential radioactive release of CPSES radioactive materials which could leak via this pathway. Complicating this surveillance task, operational experience has shown that the SSW radiation monitors periodically detect natural radionuclides in the SSW effluent. These natural radionuclides originate from washout of radon daughter products on plant surfaces following rainfall events. The detection of natural radionuclides in the SSW effluent is consistent with the normal expected function and operable status of the SSW radiation monitors. However, if a SSW radiation monitor setpoint is exceeded and an alarm is initiated (especially during or immediately after rainfall), then it is necessary to verify if the detected radioactivity is from natural radionuclides or from plant contamination by established assessment techniques. Natural radionuclides may be verified when a SSW alert setpoint only is exceeded by sampling or by comparison to the Component Cooling Water (CCW) process radiation monitors since the source of CPSES byproduct radionuclides in the SSW would be from the CCW.

Plant procedures and operating practices provide verification of detector alert or alarm conditions. The SSW effluent radiation monitors should have alert setpoints established as close to background as practical to prevent

spurious alarms and yet alarm should an inadvertent release of plant byproduct radioactive materials occur. To this end, the monitor's alert setpoint is normally established at three (3) times background. Alert setpoint alarms should be verified in accordance with plant procedures. Those alert setpoint alarms attributable to natural radionuclides should not be considered to be a plant adverse condition (i.e., release of plant contamination) and should not result in the monitor being declared inoperable.

15

The SSW effluent radiation monitor's alarm setpoint is set at a higher level threshold, based on operating experience, to prevent alarm by most natural radionuclide washout events. Events that result in a SSW effluent radiation monitor alarm setpoint alarm should be considered a plant adverse condition and be investigated in accordance with plant procedures and applicable Controls of Part I of the ODCM. If the SSW effluent stream becomes contaminated with plant byproduct radioactive materials, radionuclide concentrations should be determined from grab samples and a radiation monitor alarm setpoint determined as follows:

$$C_{sw} = (\sum_g C_g) + DF \quad \text{[Eq. 1-8]}$$

7

- Where:
- C_{sw} = Station Service Water effluent monitor alarm setpoint 15
 - C_g = Concentration of each measured gamma emitter (g), observed in the effluent (uCi/ml) 7
 - $DF = \sum_i (C_i/10ECL_i)$ = Dilution factor required to ensure limits of Control 3/4.11.1.1 are not exceeded. 12

As stated above, for the SSW effluent release pathway there is no additional dilution available. Therefore, if the calculated DF is greater than 1.0, any releases occurring via this pathway will result in a violation of Radiological Effluent Control 3/4.11.1.1. If plant byproduct radioactivity is detected in the SSW effluent, doses due to releases shall be calculated in accordance with the methodology given in Section 1.3, with the near field average dilution factor, F_k , equal to 1.0.

15

12

15

1.2.4 Auxiliary Building to LVW Pond Radiation Monitor XRE-5251A

9

The purpose of the Auxiliary Building to LVW Pond monitor (XRE-5251A) is to monitor the Auxiliary Building Sumps 3 and 11, Unit 1 and Unit 2 Diesel Generator Sumps 1 and 2 and the Unit 1 and Unit 2 Component Cooling Water Drain Tanks

9

14

continuous discharges and divert these discharges from the Pond to the Waste Water Holdup Tanks if radioactivity is detected. Since detectable radioactivity is not normally present in these discharges, the monitor setpoint should be established as close to background as practical to prevent spurious alarms and yet alarm should an inadvertent radioactive release occur. To this end, the setpoint will be initially established at three (3) times background until further data can be collected. Then, if this setpoint is exceeded, XRE-5251A will direct valves X-HV-WM182 and 183 to divert the discharges from the LVW Pond to the Waste Water Holdup Tanks where the effluent can then be sampled and released in a batch mode to Squaw Creek Reservoir, if required by Radiological Effluent Control 3/4.11.1.1, Table 4.11-1. When radioactive materials are detected in the discharges, a setpoint then may be established for XRE-5251A using the methodology in Section 1.2.1 to ensure that the limits of Control 3.11.1.1 are not exceeded in discharges to the LVW Pond.

9

12

1.3 DOSE CALCULATION FOR LIQUID EFFLUENTS

For implementation of Radiological Effluent Control 3/4.11.1.2, the dose commitment from the release of liquid effluents will be calculated at least once per 31 days and a cumulative summation of the total body and organ dose commitments will be maintained for each calendar quarter and each calendar year. Dose calculations will be performed for releases from the Plant Effluent Tanks, Waste Monitor Tanks, Laundry Holdup & Monitor Tanks, Waste Water Holdup Tanks, and the LVW Pond via the Circulating Water Tunnel at the point of discharge to Squaw Creek Reservoir. Although the LVW Pond is located in a CONTROLLED AREA, dose calculations for discharges to the LVW Pond will not be performed because there are no real pathways for exposure to members of the public. Doses for these pathways will be calculated when the LVW Pond is discharged to Squaw Creek Reservoir. The cumulative dose over the desired time period (e.g., the sum of all doses due to releases during a 31 day period, calendar quarter, or a calendar year) will be calculated using the following equation:

$$D_T = \sum_k D_k + \sum_m D(\text{lake})_m \quad [\text{Eq 1-9}]$$

Where D_T = the dose commitment to the total body or any organ due to all releases during the desired time interval from all release sources (mrem).

D_k = the dose commitment received by the total body or any organ during the duration of release k (mrem). The equation for calculating D_k is given in Section 1.3.1 (Eq. 1-10)

$D(\text{lake})_m$ = the dose commitment received by the total body or any organ during the desired time period, m , (normally $m = 31$ days) due to the buildup in the lake of previously discharged radionuclides. The equation for calculating $D(\text{lake})_m$ is given in Section 1.3.2 (Eq. 1-12).

To demonstrate compliance with the dose limits of Control 3/4.11.1.2, the calculated cumulative dose (i.e., the total dose for both units) will be compared to two times the dose limits for a unit. In other words, the dose assigned to each unit will be one-half of the total doses from all releases from the site.

8

1.3.1 Calculation of Dose Due to Liquid Releases

7

The dose commitment to the total body or any organ due to a release will be calculated using the following equation.

7

$$D_k = \sum_i A_i t_k C_{ik} F_k \quad [\text{Eq. 1-10}]$$

7

Where: t_k = the time duration of the release k (hrs)

7

C_{ik} = The isotopic concentration (uCi/ml) of radionuclide i found in the release sample for release k. Concentrations are determined primarily from gamma isotopic analysis of the liquid effluent sample. For Sr-89, SR-90, H-3, Fe-55 and alpha emitters, the last measured value will be used in the dose calculation.

7

F_k = The near field average dilution factor during a liquid effluent release. This is defined as the ratio of the average undiluted liquid effluent flow rate to the average Circulating water flow rate during the release. The average liquid effluent flow rate is based on the actual average flow into the Circulating water during the release.

7

$$F_k = \frac{\text{average undiluted liquid effluent flow rate}}{\text{circulating water flow rate}}$$

7

$A_{i\tau}$ = the site related ingestion dose commitment factor for the total body or any organ, τ , for each identified gamma or beta emitter (mrem/hr per uCi/ml). $A_{i\tau}$ is calculated as follows: 7

$$A_{i\tau} = 1.14 \times 10^5 (U_w/D_w + U_f BF_i) DF_i \quad \text{[Eq. 1-11]} \quad 7$$

Where: 1.14×10^5 = unit conversion factor, 7

U_w = adult water consumption from Squaw Creek Reservoir, 0 liters/yr for CPSES. 8

U_f = adult fish consumption, 21 kg/yr 7

BF_i = bioaccumulation factor for radionuclide i , in fish from Table A-1, Ref. 2 (pCi/kg per pCi/l) 7

DF_i = adult dose conversion factor for radionuclide i , from Table E-11, Ref. 2 (mrem/pCi ingested) 7

D_w = Dilution factor from the near field area within one-quarter mile of the release point to the potable water intake for the adult water consumption; 1.0 for CPSES. (unitless) 7

Calculated values for $A_{i\tau}$ are given in Table 1.2.

1.3.2 Calculation of Dose Due to Radionuclide Buildup in the Lake 7

The dose contribution from significant pathways, due to buildup of previously discharged radionuclides in the lake, must be considered in the committed dose calculation only if 8

radioactivity is detected in the water of Squaw Creek Reservoir or in fish from Squaw Creek Reservoir. Based on the design calculations presented in the CPSES FSAR, Appendix 11A and documented in CPSES Engineering Calculation No. ME-CA-0000-3161, the significant pathways included in this calculation are fish consumption from Squaw Creek Reservoir and consumption of meat from cows drinking water from Squaw Creek. Additionally, consumption of milk from cows drinking water from Squaw Creek is included, but a CPSES site-specific consumption factor of 0 is normally used since there are no identified animals milked for human consumption along Squaw Creek. If animals milked for consumption are identified along Squaw Creek during the annual land use census, this pathway should be included in the dose calculation. Also, water from Squaw Creek Reservoir or Squaw Creek is not used as a source of drinking water, so the drinking water pathway is not included in dose calculations.

8

To further simplify the calculation, the dose due to consumption of meat and milk from cows drinking water from Squaw Creek is only calculated for tritium. CPSES Engineering Calculation No. ME-CA-0000-3161 shows that tritium is the only isotope routinely released from CPSES that significantly contributes to the dose from these pathways (i.e., >95% of the total dose). The calculation does show a significant dose contribution from Ru-106 for the cow-meat pathway, but this isotope has not historically been observed in actual CPSES liquid effluent samples. The dose from the fish consumption pathway will be calculated for all measured isotopes.

8

The contribution to the total dose due to the buildup of radionuclides in the reservoir is determined as follows:

8

$$D(\text{lake})_m = 1.14 \times 10^{-4} [(\sum_i DF_i C'_{if} U_f) + DF_t C'_{tw} Q_{aw} (U_{\text{milk}} F_{mt} + U_{\text{meat}} F_{ft})]$$

8

[Eq. 1-12]

Where: 1.14×10^{-4} = units conversion factor (yr/hr)

C'_{if}	=	concentration of radionuclide i in fish sampled from Squaw Creek Reservoir from location F1 or Table 3.1 and Figure 3.1 of this manual (pCi/kg)	7
DF_t	=	adult ingestion dose conversion factor for tritium for the organ of interest from Table E-11, Ref. 2 (mrem/pCi).	8
C'_{tw}	=	concentration of tritium in the reservoir. This value shall correspond to the highest concentration measured at any Squaw Creek Reservoir sample location (pCi/l).	8
Q_{aw}	=	the consumption rate of contaminated water by a cow, 60 l/day from Table E-3, Ref. 2.	8
U_{milk}	=	adult milk consumption rate. A CPSES site specific useage factor of 0 is normally used unless milk cows are identified along Squaw Creek during the annual Land Use Census. If milk cows are identified, a value of 310 l/yr from Table E-5, Ref. 2, should be used.	8
F_{mt}	=	the stable element transfer coefficient for tritium that relates the daily intake rate of tritium by a cow to the concentration in milk, $1.0E-2$ pCi/l per pCi/day from Table E-1, Rev. 2.	8
U_{meat}	=	adult meat consumption rate, 110Kg/yr from Table E-5, Ref. 2.	8
F_{ft}	=	the stable element transfer coefficient for tritium that relates the daily intake rate of tritium by a cow to the concentration in meat, $1.2E-2$ pCi/kg per pCi/day.	8

Rev. 8

All other variables are previously defined.

7

NOTE: This calculation is only required if activity is detected in water and/or fish in excess of the appropriate LLD values given in Radiological Effluent Control 3/4.12.1, Table 4.12-1. If the measured activity in water or fish is less than the required LLD values, the concentration for that particular pathway is assumed to be zero.

7

1.4 DOSE PROJECTIONS FOR LIQUID EFFLUENTS

7

Radiological Effluent Control 3/4.11.1.3 requires that appropriate portions of the liquid radwaste treatment system be used to reduce releases of radioactivity when the projected doses due to the liquid effluent from each reactor unit to CONTROLLED AREAS and UNRESTRICTED AREAS would exceed 0.06 mrem total body or 0.2 mrem to any organ in a 31-day period. The following calculational method is provided for performing this dose projection.

8

7

At least once every 31 days, the total dose from liquid releases for each unit for the previous three months will be divided by the number of days in the three month period and multiplied by 31. Also, this dose projection may include the estimated dose for a unit due to any anticipated unusual releases during the period for which the projection is made. If the projected dose for a unit exceeds 0.06 mrem total body or 0.2 mrem for any organ, appropriate portions of the Liquid Radwaste Treatment System shall be used to reduce radioactivity levels prior to release.

8

1.5 DEFINITIONS OF COMMON LIQUID EFFLUENT PARAMETERS

7

<u>TERM</u>	<u>DEFINITION</u>	
ADF	Actual Dilution Factor (unitless). This is defined as the ratio of the effluent flow rate plus the circulating water flow rate divided by the effluent flow rate.	7
$A_{i\tau}$	The site related ingestion dose commitment factor to the total body or any organ, τ , for each identified gamma or beta emitter, i . (mRem/hr per uCi/ml)	7
BF_i	Bioaccumulation factor for radionuclide, i , in fish from Reg. Guide 1.109. (pCi/kg per pCi/l)	7
C_a	the concentration of alpha emitters in liquid waste as measured in the analysis of the most recent monthly composite sample required by Radiological Effluent Control 3/4.11.1.1, Table 4.11-1. (uCi/ml)	7
C_{Fe}	The concentration of ^{55}Fe in liquid waste as measured in the analysis of the most recent quarterly composite sample required by Radiological Effluent Control 3/4.11.1.1, Table 4.11-1. (uCi/ml)	7
C_g	The concentration of each measured gamma emitter, g in the waste tank as measured in the analysis of the sample of each batch as required by Radiological Effluent Control 3/4.11.1.1, Table 4.11-1 (uCi/ml)	7
C_i	The concentrations of radionuclide, i , in the waste tank. (uCi/ml)	7
C'_i	The concentration of radionuclide i in the Reservoir as measured in the analysis of the monthly sample of the Reservoir required by Radiological Effluent Control 3/4.12.1, Table 3.12-1. This sample is taken at the Circulatory Water Intake Structure as indicated by location SW6 on Table 3.1 and Figure 3-1 of this manual. (uCi/ml)	7
C'_{if}	The concentration of radionuclide i in fish sampled from the reservoir from location F1 on Table 3.1 and Figure 3-1 of this manual (pCi/kg).	7
C_{ik}	The isotopic concentration of radionuclide i found in the pre-release sample for batch release k . Concentrations are determined primarily from gamma isotopic analysis of the liquid effluent sample. For ^{89}Sr , ^{90}Sr , 3H , ^{55}Fe and alpha emitters, the last measured value will be used. (uCi/ml)	7

<u>TERM</u>	<u>DEFINITION</u>	
C'_{iw}	The maximum concentration of radionuclide i in SCR as measured in analysis of monthly samples of SCR.	12
C_{lw}	The liquid waste effluent monitor alarm setpoint. This corresponds to the gamma concentration in the undiluted waste stream which after dilution would result in a release at the limits of Control 3.11.1.1. (uCi/ml)	
C_s	The concentration of ^{89}Sr and ^{90}Sr in liquid waste as measured in the analysis of the most recent quarterly composite sample required by Radiological Effluent Control 3/4.11.1.1, Table 4.11-1. (uCi/ml)	7
C_{sw}	The Station Service Water effluent monitor alarm setpoint. (uCi/ml).	15
C_t	The concentration of ^3H in liquid waste as measured in the analysis of the most recent monthly composite sample required by Radiological Effluent Control 3/4.11.1.1, Table 4.11-1. (uCi/ml)	7
DF_i	Adult dose conversion factor for radionuclide, i , from Reg. Guide 1.109. (mrem/pCi ingested)	
D_k	The dose commitment received by the total body or any organ during the duration of batch release k of liquid effluents. (mRem)	
$D(\text{lake})_m$	The dose commitment received by the total body or any organ during a desired time period, m , due to the buildup in the lake of previously discharged radionuclides. (mRem)	
D_T	The total dose commitment to the total body or any organ due to all releases of liquid effluents during a desired time interval. (mRem)	
D_w	Dilution factor, from the near field area within 1/4 mile of the release point to the potable water intake for adult water consumption, 1.0 for CPSES. (unitless)	
f	Effluent flow rate. (gpm)	
F	Circulating water flow rate (or dilution flow rate). (gpm)	
F'	Adjusted Circulating water flow rate to account for buildup of radionuclides in the Circulating water due to previous releases. (gpm)	

<u>TERM</u>	<u>DEFINITION</u>	
F _k	The near field average dilution factor during a liquid effluent release (unitless). This is defined as the ratio of the average undiluted liquid waste flow to the average Circulating water flow during the release.	7
ECL _a	Effluent Concentration Limit* of a mixture of unidentified alpha emitters. (uCi/ml)	8
ECL _{Fe}	Effluent Concentration Limit* of ⁵⁵ Fe. (uCi/ml)	
ECL _g	Effluent Concentration Limit* of each identified gamma emitter, g. (uCi/ml)	
ECL _i	Effluent Concentration Limit* of radionuclide, i. (uCi/ml).	
ECL _s	Effluent Concentration Limit* of a mixture of ⁸⁹ Sr and ⁹⁰ Sr. (uCi/ml)	
ECL _t	Effluent Concentration Limit* of tritium (³ H). (uCi/ml).	
SF	Safety Factor of 2. Used in the calculation of the Required Dilution Factor (RDF) for liquid releases to provide a margin of assurance that the instantaneous concentration limits are not exceeded.	7
RDF	Required Dilution Factor (unitless). This is defined as the dilution factor that ensures that 10 times the effluent concentrations expressed in 10CFR20, Appendix B, Table 2, Column 2, are not exceeded at the point of release to CONTROLLED AREAS and UNRESTRICTED AREAS during a discharge.	12
t _k	The time duration of batch release k. (hours)	7
U _f	Adult fish consumption. (kg/yr)	
U _w	Adult water consumption. (liters/yr)	

* Effluent Concentration limits (ECL) for liquids are given in 10CFR20, Appendix B, Table 2, Column 2. A value of 2×10^{-4} uCi/ml for dissolved or entrained noble gas shall be used.

TABLE 1.1

SUMMARY OF LIQUID RELEASE PATHWAYS1. RELEASES TO SCR VIA THE CIRC WATER DISCHARGE

Release Source	Release Type	Max Flow Rate (gpm)	Max Vol (gal)	Monitor
PET-1	Batch	100	30000	XRE-5253
PET-2	Batch	100	30000	XRE-5253
WMT-1	Batch	100	5340	XRE-5253
WMT-2	Batch	100	5340	XRE-5253
LHMT-1	Batch	100	5875	XRE-5253
LHMT-2	Batch	100	5875	XRE-5253
WWHT-1	Batch	300	30500	None
WWHT-2	Batch	300	30500	None
LVW Pond	Continuous	1600	-	None

2. RELEASES TO THE WASTE WATER MANAGEMENT SYSTEM

Release Source	Release Type	Max Flow Rate (gpm)	Max Vol (gal)	Monitor
CPBWRT-A	Batch	1550	8500	None
CPBWRT-B	Batch	1550	17000	None
WWHT-1	Batch	200	33100	None
WWHT-2	Batch	200	33100	None
TBSump2 (Unit1)	Continuous	300	-	1RE-5100
TBSump4 (Unit2)	Continuous	300	-	2RE-5100
AB Secondary*	Continuous	380	-	XRE-5251A
Temporary holdup tanks	Batch	**	**	None

** Maximum flow and volume will be determined by temporary systems design.

3. DIRECT RELEASES TO SCR (SAFE SHUTDOWN IMPOUNDMENT)

Release Source	Release Type	Max Flow Rate (gpm)	Max Vol (gal)	Monitor
Unit 1 SSW Train A	Continuous	17,000	-	1RE-4269
Unit 1 SSW Train B	Continuous	17,000	-	1RE-4270
Unit 2 SSW Train A	Continuous	17,000	-	2RE-4269
Unit 2 SSW Train B	Continuous	17,000	-	2RE-4270

NOTE:

* AB Secondary Effluents contain the following sources:

	Max. Flow (gpm)
Auxiliary Building Sump 3	50
Auxiliary Building Sump 11	50
Diesel Generator Sump 1 (Unit 1)	50
Diesel Generator Sump 2 (Unit 1)	50
Diesel Generator Sump 1 (Unit 2)	50
Diesel Generator Sump 2 (Unit 2)	50
CCWDT (Unit 1)	40
CCWDT (Unit 2)	40

TABLE 1.2
 PAGE (1 of 4)
 SITE RELATED INGESTION DOSE COMMITMENT FACTOR $A_{i,r}$
 (mRem/hr per uCi/ml)

<u>ISOTOPE</u>	<u>BONE</u>	<u>LIVER</u>	<u>T-BODY</u>	<u>THYROID</u>	<u>KIDNEY</u>	<u>LUNG</u>	<u>GI-LLI</u>	
H-3	0.00E+00	2.26E-01	2.26E-01	2.26E-01	2.26E-01	2.26E-01	2.26E-01	8
C-14	3.13E+04	6.25E+03	6.25E+03	6.25E+03	6.25E+03	6.25E+03	6.25E+03	8
NA-24	4.07E+02	4.07E+02	4.07E+02	4.07E+02	4.07E+02	4.07E+02	4.07E+02	8
P-32	4.62E+07	2.87E+06	1.79E+06	0.00E+00	0.00E+00	0.00E+00	5.20E+06	8
CR-51	0.00E+00	0.00E+00	1.27E+00	7.62E-01	2.80E-01	1.69E+00	3.20E+02	8
MN-54	0.00E+00	4.38E+03	8.35E+02	0.00E+00	1.31E+03	0.00E+00	1.34E+04	8
MN-56	0.00E+00	1.10E+02	1.95E+01	0.00E+00	1.40E+02	0.00E+00	3.51E+03	8
FE-55	6.58E+02	4.55E+02	1.06E+02	0.00E+00	0.00E+00	2.54E+02	2.61E+02	8
FE-59	1.04E+03	2.44E+03	9.35E+02	0.00E+00	0.00E+00	6.82E+02	8.16E+03	8
CO-58	0.00E+00	8.91E+01	2.00E+02	0.00E+00	0.00E+00	0.00E+00	1.81E+03	8
CO-60	0.00E+00	2.56E+02	5.65E+02	0.00E+00	0.00E+00	0.00E+00	4.81E+03	8
NI-63	3.11E+04	2.16E+03	1.05E+03	0.00E+00	0.00E+00	0.00E+00	4.50E+02	8
NI-65	1.26E+02	1.64E+01	7.49E+00	0.00E+00	0.00E+00	0.00E+00	4.16E+02	8
CU-64	0.00E+00	9.97E+00	4.68E+00	0.00E+00	2.51E+01	0.00E+00	8.49E+02	8
ZN-65	2.32E+04	7.37E+04	3.33E+04	0.00E+00	4.93E+04	0.00E+00	4.65E+04	8
ZN-69	4.93E+01	9.44E+01	6.56E+00	0.00E+00	6.13E+01	0.00E+00	1.42E+01	8
BR-83	0.00E+00	0.00E+00	4.05E+01	0.00E+00	0.00E+00	0.00E+00	5.82E+01	8
BR-84	0.00E+00	0.00E+00	5.24E+01	0.00E+00	0.00E+00	0.00E+00	4.11E-04	8
BR-85	0.00E+00	0.00E+00	2.15E+00	0.00E+00	0.00E+00	0.00E+00	1.01E-15	8
RB-86	0.00E+00	1.01E+05	4.71E+04	0.00E+00	0.00E+00	0.00E+00	2.00E+04	8
RB-88	0.00E+00	2.94E+02	1.56E+02	0.00E+00	0.00E+00	0.00E+00	3.93E-09	8
RB-89	0.00E+00	1.95E+02	1.37E+02	0.00E+00	0.00E+00	0.00E+00	1.13E-11	8
SR-89	2.21E+04	0.00E+00	6.35E+02	0.00E+00	0.00E+00	0.00E+00	3.55E+03	8
SR-90	5.47E+05	0.00E+00	1.33E+05	0.00E+00	0.00E+00	0.00E+00	1.58E+04	8
SR-91	4.07E+02	0.00E+00	1.64E+01	0.00E+00	0.00E+00	0.00E+00	1.94E+03	8
SR-92	1.54E+02	0.00E+00	6.67E+00	0.00E+00	0.00E+00	0.00E+00	3.06E+03	8
Y-90	5.77E-01	0.00E+00	1.54E-02	0.00E+00	0.00E+00	0.00E+00	6.11E+03	8
Y-91M	5.44E-03	0.00E+00	2.11E-04	0.00E+00	0.00E+00	0.00E+00	1.60E-02	8
Y-91	8.45E+00	0.00E+00	2.25E-01	0.00E+00	0.00E+00	0.00E+00	4.64E+03	8
Y-92	5.06E-02	0.00E+00	1.48E-03	0.00E+00	0.00E+00	0.00E+00	8.87E+02	8

TABLE 1.2
 SITE RELATED INGESTION DOSE COMMITMENT FACTOR A_{IT}
 (mRem/hr per uCi/ml)
 PAGE 3 of 4

<u>ISOTOPE</u>	<u>BONE</u>	<u>LIVER</u>	<u>T-BODY</u>	<u>THYROID</u>	<u>KIDNEY</u>	<u>LUNG</u>	<u>GI-LLI</u>
BA-140	1.94E+02	2.45E-01	1.27E+01	0.00E+00	8.30E-02	1.39E-01	4.00E+02
BA-141	4.51E-01	3.41E-04	1.53E-02	0.00E+00	3.17E-04	1.93E-04	2.06E-10
BA-142	2.04E-01	2.09E-04	1.28E-02	0.00E+00	1.77E-04	1.19E-04	2.87E-19
LA-140	1.50E-01	7.53E-02	1.99E-02	0.00E+00	0.00E+00	0.00E+00	5.52E+03
LA-142	7.66E-03	3.16E-03	8.66E-04	0.00E+00	0.00E+00	0.00E+00	2.54E+01
CE-141	2.24E-02	1.51E-02	1.72E-03	0.00E+00	7.05E-03	0.00E+00	5.79E+01
CE-143	3.94E-03	2.91E+00	3.24E-04	0.00E+00	1.29E-03	0.00E+00	1.09E+02
CE-144	1.17E+00	4.89E-01	6.26E-02	0.00E+00	2.91E-01	0.00E+00	3.94E+02
PR-143	5.52E-01	2.21E-01	2.73E-02	0.00E+00	1.28E-01	0.00E+00	2.41E+03
PR-144	1.80E-03	7.49E-04	9.16E-05	0.00E+00	4.23E-04	0.00E+00	2.59E-10
ND-147	3.76E-01	4.35E-01	2.60E-02	0.00E+00	2.54E-01	0.00E+00	2.09E+03
W-187	2.95E+02	2.48E+02	8.65E+01	0.00E+00	0.00E+00	0.00E+00	8.11E+04
NP-239	2.86E-02	2.79E-03	1.54E-03	0.00E+00	8.74E-03	0.00E+00	5.74E+02
*SB-122	4.42E+00	8.71E-02	1.29E+00	6.01E-02	0.00E+00	2.30E+00	1.27E+03
**SB-124	5.38E+01	1.01E+00	2.12E+01	1.30E-01	0.00E+00	4.18E+01	1.52E+03
**BR-82	0.00E+00	0.00E+00	1.78E+02	0.00E+00	0.00E+00	0.00E+00	2.05E+02
**SB-125	4.27E+01	4.58E-01	8.58E+00	3.80E-02	0.00E+00	4.45E+03	3.78E+02
**SB-126	2.20E+01	4.47E-01	7.93E+00	1.35E-01	0.00E+00	1.35E+01	1.80E+03
**SB-127	4.94E+00	1.80E-01	1.90E+00	5.94E-02	0.00E+00	2.93E+00	1.13E+03
**LA-141	1.14E-02	3.55E-03	5.81E-04	0.00E+00	0.00E+00	0.00E+00	4.23E+02

16

8

- * The adult dose conversion factors, DF_i , for Sb-122 are not published in Reference 2. The calculation of dose conversion factors and site-related ingestion dose commitment factors for Sb-122 is documented in Reference 10. 5

- ** The adult dose conversion factors, DF_i , for Sb-124, Sb-125, Br-82, Sb-126, Sb-127 and La-141 are not published in Reference 2. The site-related dose commitment factors for Sb-124, Sb-125, Br-82, Sb-126, Sb-127 and La-141 were calculated using the "Adult Ingestion Dose Factors" given in Table A-3 of Reference 11, and Equation 1-11 of Part II, Section 1.3.1 of this Manual. 7
8

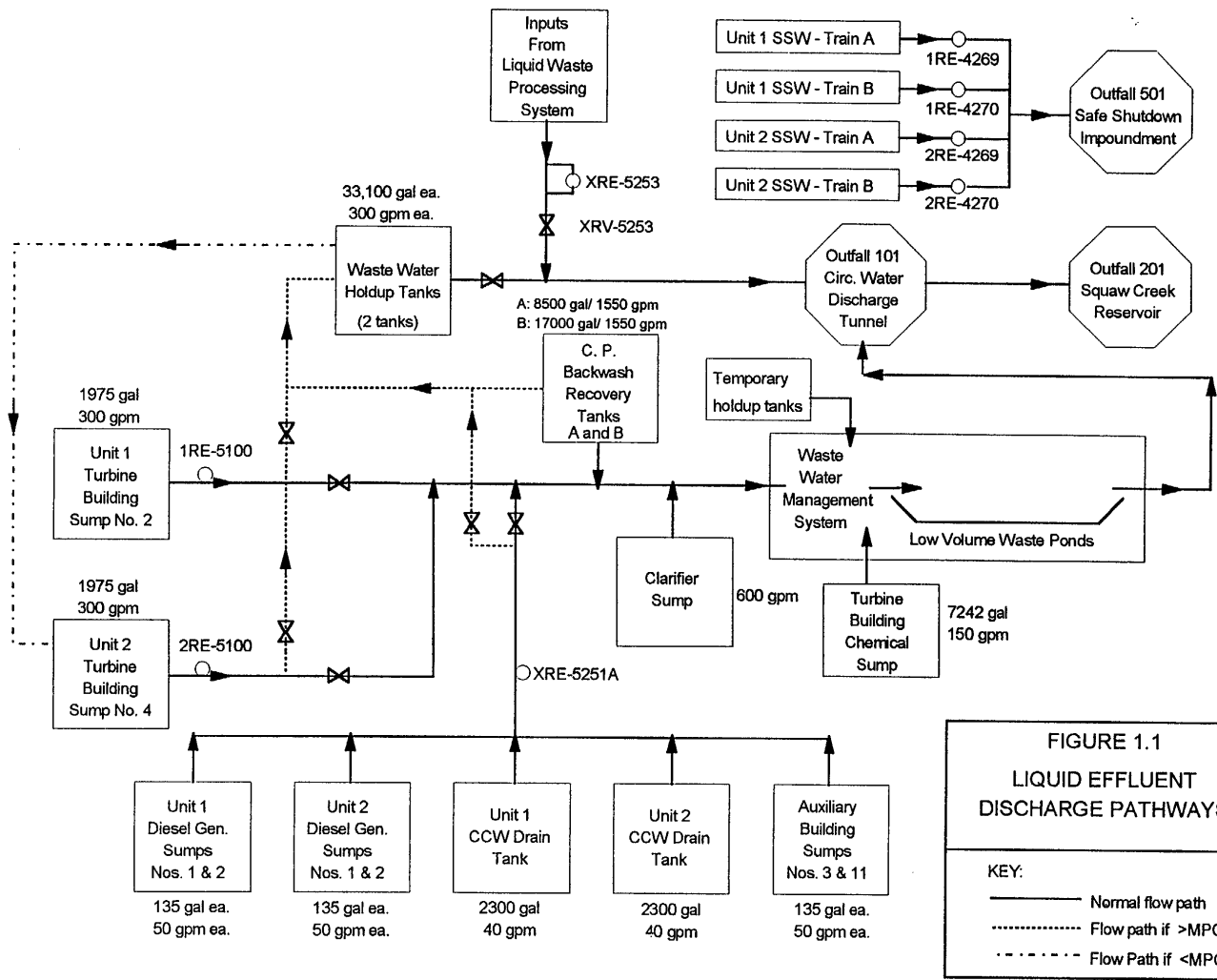

THIS PAGE INTENTIONALLY LEFT BLANK

FIGURE 1.2

INGERSOLL-RAND CURVE # NV-3662-4
for Pump 83 APMA-1
DATE 8/26/77

DESIGN CONDITIONS

GPM 275,000 EFF 88
TH (FT) 28 BHP 2200 @ Q 1.0
RPM 2600 DRIVER 2600
1.18 SF

CIRCULATING WATER PUMP CURVES

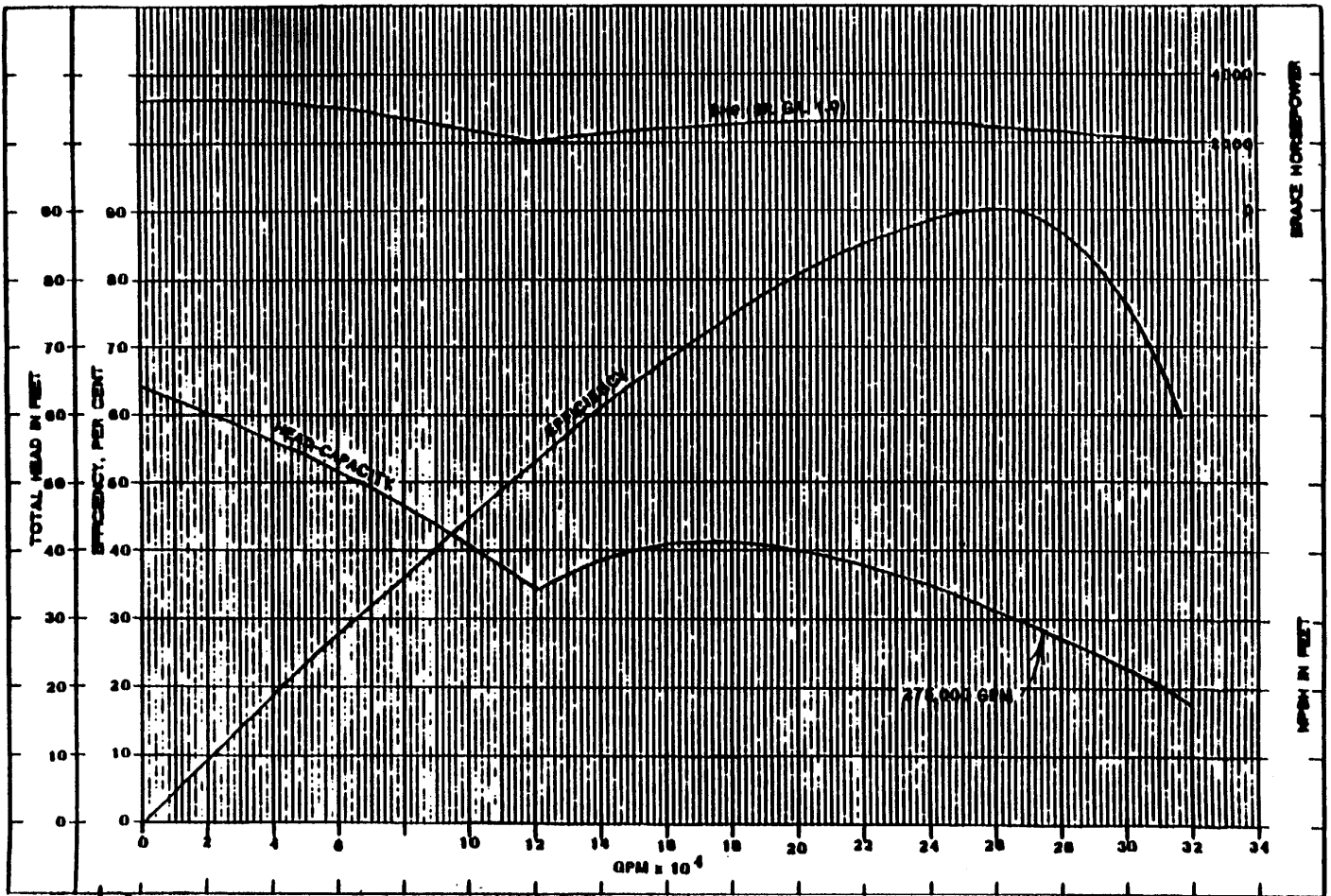

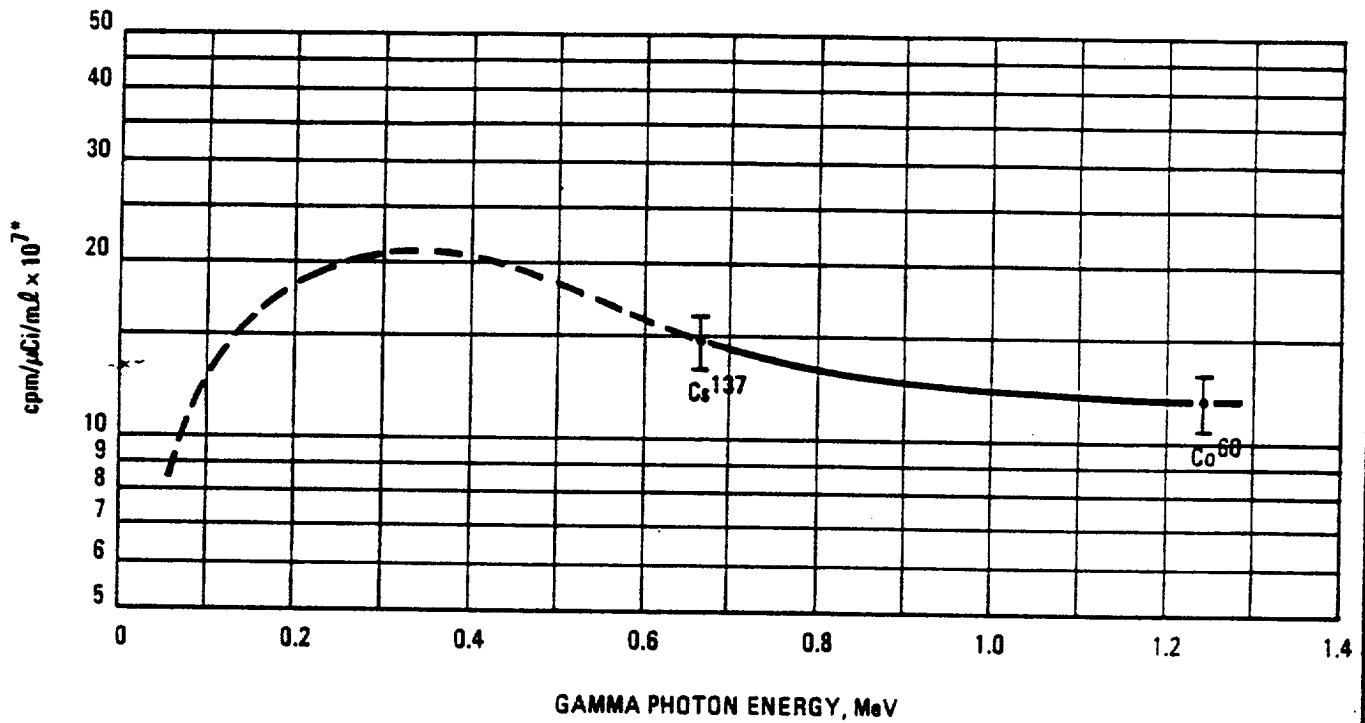

GAMMA PHOTON ENERGY, MeV
 ENERGY RESPONSE TO GAMMA RADIATIONS
 FOR RD-33 TYPE DETECTOR

Figure 1.3

†The broken portion of the curve was generated from early isotopic calibrations using a chamber of similar geometry.
 *Based on one gamma per disintegration.

SECTION 2.0
GASEOUS EFFLUENTS

8

At CPSES, normal radioactive gaseous effluents are collected in a common exhaust air intake plenum, processed through charcoal and HEPA filters, and discharged to the atmosphere through the two common Plant Vent Stacks designated as Stack A and Stack B. Due to the fact that these release points are below the height of the nearest adjacent structure (i.e., containment building), all gaseous releases from these stacks are conservatively assumed to be entrained into the building wake and cavity regions, which results in a conservative ground-level release.

8

Routine gaseous effluent releases may occur from the Unit 1 and Unit 2 Containment Buildings (purges and vents), Waste Gas Decay Tanks (WGDT), and the plant vent stacks (continuous ventilation). The normal ventilation exhaust via the plant vent stacks is considered a continuous release. Containment Building vents for pressure relief and WGDT discharges are treated as batch releases. Because Containment Building purges are only allowed during MODES 5 and 6 and because radioactivity is discharged rapidly from the containment atmosphere during purges, the first portion (i.e., the release period during which most containment atmospheric radioactivity is discharged) of a Containment Building purge is considered a batch release. The remainder of a purge is treated as a contribution to the continuous release already occurring through the plant vent stacks.

10

8

8

Operating experience has shown that occasional releases may be required from Pressurizer Relief Tank (PRT) vents for depressurizing the RCS during outages, from Volume Control Tank (VCT) vents during maintenance on the Waste Gas Processing System, from the Containment Buildings during Integrated Leak Rate Tests (ILRT), and from secondary steam releases (potentially radioactive during periods of primary-to-secondary leaks). These releases occur infrequently and are treated as batch releases.

A summary of all gaseous effluent release points, release sources, flow rates (if applicable) and associated radiation monitors is shown in Table 2.1. A flow diagram of all gaseous effluent discharge pathways is shown in Figure 2.1.

8

Each Plant Vent Stack is equipped with a Wide Range Gas Monitor (WRGM) and a Particulate, Iodine, and Noble Gas (PIG) Monitor. These monitors are part of the plant Digital Radiation Monitoring System (DRMS) supplied by Sorrento Electronics (formerly General Atomics). Since all DRMS monitors provide a digital output, they may be calibrated to read out in the appropriate engineering units (i.e., uCi/ml). The conversion factor for detector output from counts per minute to uCi/ml is determined during the calibration of each individual monitor, and is input into the data base for the monitor microprocessor.

8

The WRGMs are designated as monitors XRE-5570A and XRE-5570B for Stacks A and B, respectively. Each WRGM consists of a low range (10^{-7} to 10^{-1} uCi/cc), mid range (10^{-4} to 10^2 uCi/cc), and high range (10^{-1} to 10^5 uCi/cc) noble gas activity detector. The WRGMs also have an effluent release rate channel which uses inputs from the appropriate WRGM noble gas activity detectors and the plant vent stack flow rate detectors (X-FT-5570A-1/B-1) to provide an indication of noble gas release rate in uCi/sec. Alarm setpoints are established for the WRGM effluent release rate channel to fulfill the requirements of Radiological Effluent Control 3/4.3.3.5. Exceeding the WRGM effluent release rate channel high alarm setpoint also initiates automatic termination of Waste Gas Decay Tank releases.

4

The stack PIGs are designated as particulate channels XRE-5568A and XRE-5568B, iodine channels XRE-5575A and XRE-5575B, and noble gas channels XRE-5567A and XRE-5567B for Stacks A and B, respectively. The stack PIG noble gas channels may be used as a back-up to the WRGM when no automatic control functions are

required. Therefore, a methodology is provided for calculating the PIG noble gas monitor setpoints. Methodologies are not provided for calculating setpoints for the PIG particulate and iodine channels, since these channels are not required by the Radiological Effluent Controls Program, and because it is not practical to establish instantaneous setpoints for integrating type monitors (reference 1).

8

Other monitors that may be used for effluent monitoring and control are the Auxiliary Building Ventilation Duct Monitor, XRE-5701, and the Containment PIG Noble Gas Monitors, 1RE-5503 and 2RE-5503. XRE-5701 may be used to monitor Waste Gas Decay Tank releases by monitoring the Auxiliary Building Ventilation Duct. XRE-5701 also provides the automatic control function for termination of Waste Gas Decay Tank releases. 1RE-5503 and 2RE-5503 monitor the Unit 1 and Unit 2 Containment atmospheres, respectively, and provide the only automatic control function for termination of Containment vents or purges.

8

8

2.1 RADIOLOGICAL EFFLUENT CONTROL 3/4.11.2.1 COMPLIANCE

8

2.1.1 Dose Rates Due to Noble Gases

For implementation of Radiological Effluent Control 3/4.11.2.1.a, the dose rate to the total body and skin of an individual at the SITE BOUNDARY due to noble gases released from the site shall be calculated as follows:

8

A. Total body dose rate due to noble gases

8

$$D_t = \sum_v D_{tv} = \sum_v \overline{(X/Q)} \sum_{\text{(noble gases)}} K_i Q_{iv} \quad [\text{Eq. 2-1}]$$

Where: D_t = the total body dose rate at the SITE BOUNDARY due to noble gases from all release sources (mRem/yr)

8

D_{tv} = the total body dose rate at the SITE BOUNDARY due to noble gases from release source v (mrem/yr).

8

$(\overline{X/Q})$ = Highest annual average relative concentration at the SITE BOUNDARY (3.3×10^{-6} sec/m³ in the NNW sector at a distance of 1.29 miles from the plant*)

NOTE: The annual average $\overline{X/Q}$ is also used in determining setpoints for containment purge or vent as required by Technical Specification 3.3.6.

K_i = Total body dose factor due to gamma emissions from noble gas radionuclide i from Table 2.2 (mRem/yr per uCi/m³)

Q_{iv} = Total release rate of noble gas radionuclide i from the release source v (uCi/sec) (See C below for calculation of Q_{iv})

v = Index over all release sources

b. Skin Dose Rate Due To Noble Gases

$$D_s = \sum_v D_{sv} = \sum_v (\overline{X/Q}) \sum_{\text{(noble gases)}} (L_i + 1.1 M_i) Q_{iv}$$

[Eq. 2-2]

Where: D_s = Skin dose rate at the SITE BOUNDARY due to noble gases from all release sources. (mRem/yr)

D_{sv} = Skin dose rate at the SITE BOUNDARY due to noble gases from release source v . (mRem/yr)

* Reference 4, Section 2.3.5.2.

L_i = the skin dose factor due to beta emissions from noble gas radionuclide i from Table 2.2 (mRem/yr per $\mu\text{Ci}/\text{m}^3$) 8

1.1 = conversion factor of mRem skin dose per mRad air dose.

M_i = air dose factor due to gamma emissions from noble gas radionuclide i from Table 2.2 (mRad/yr per $\mu\text{Ci}/\text{m}^3$) 8

All other terms are as previously defined.

C. Release Rate 8

Q_i is defined as the total release rate ($\mu\text{Ci}/\text{sec}$) of radionuclide i from all release sources. Q_i is given by: 8

$$Q_i = \sum_v Q_{iv} = \sum_v X_{iv} F_v \quad [\text{Eq. 2-3}] \quad 8$$

Where: X_{iv} = the measured concentration of radionuclide i present in each release source v ($\mu\text{Ci}/\text{cm}^3$) 8

F_v = the flow rate from each release source v (cm^3/sec) 8

Q_{iv} = the release rate of radionuclide i from release source v ($\mu\text{Ci}/\text{sec}$) 8

v = index over all release sources 8

2.1.2 Dose Rates Due to Radioiodines, Tritium, and Particulates 8

Organ dose rates due to iodine-131 and iodine-133, tritium, and all radioactive materials in particulate form with half-lives greater than eight days released from the site will be calculated to implement the requirements of Radiological Effluent Control 3/4.11.2.1.b as follows: 8

$$D_o = \sum_v D_{ov} = \sum_v (\overline{X/Q}) \sum_{\text{IP\&T}} P_i Q_i \quad [\text{Eq. 2-4}]$$

- Where: D_0 = the total organ dose rate due to iodine-131, iodine-133, particulates with half-lives greater than eight days, and tritium from all release sources. (mrem/yr.) 8
- D_{OV} = the organ dose rate due to iodine-131, iodine-133, particulates with half-lives greater than eight days, and tritium from release source v (mrem/yr) 8
- P_i = pathway dose rate parameter factor for radionuclide, i, (for radioiodines, particulates, and tritium) for the inhalation pathway in mRem/yr per $\mu\text{Ci}/\text{m}^3$ (Table 2.3). The methodology used for determining values of P_i is given in Appendix A. 8
- IP&T = iodine-131, iodine-133, particulates with half-lives greater than eight days, and tritium. These are the isotopes over which the summation function is to be performed. 8

All other variable are previously defined.

2.2 GASEOUS EFFLUENT MONITOR SETPOINTS 8

The gaseous monitor setpoint values, as determined using the methodology in the following sections, will be regarded as upper bounds for the actual setpoint adjustments. Setpoints may be established at values lower than the calculated values if desired. Further, if the calculated value should exceed the maximum range of the monitor, the setpoint shall be adjusted to a value that falls within the normal operating range of the monitor. 8

If a calculated setpoint is less than the measured concentration associated with the particular release pathway, no release may be made. Under such circumstances, contributing source terms shall be reduced and the setpoint recalculated. 8

XRE-5570A and XRE-5570B Effluent Release Rate Channels

The WRGM effluent release rate channels monitor the release rate of radioactive materials from each plant vent stack by combining inputs from the WRGM low range noble gas activity channel ($\mu\text{Ci}/\text{cm}^3$) indication and a stack flow rate (cm^3/sec) indication (X-FT-5570A-1/B-1) to yield an effluent release rate ($\mu\text{Ci}/\text{sec}$). By establishing an alarm setpoint for this monitor, an increase in either the noble gas activity or stack flow rate will cause an alarm trip. The WRGM effluent channel also provides an automatic control function for termination of Waste Gas Decay Tank Releases. The setpoint for each plant vent effluent release rate monitor will be calculated using the following methodology:

Q_{SITE} = the lessor of:

$$Q_{\text{NG}} \frac{500}{D_t} \times SF = 125 \frac{Q_{\text{NG}}}{D_t} \quad [\text{Eq. 2.5}]$$

OR

$$Q_{\text{NG}} \frac{3000}{D_s} \times SF = 750 \frac{Q_{\text{NG}}}{D_s} \quad [\text{Eq. 2.6}]$$

Where: Q_{site} = Total site noble gas release rate limit corresponding to a dose rate at or beyond the SITE BOUNDARY of 500 mrem/yr to the total body or 3000 mrem/yr to the skin. ($\mu\text{Ci}/\text{sec}$)

$Q_{\text{NG}} = \sum$ (noble gases) Q_i
 = Actual release rate of noble gases from all release sources as calculated from the radionuclide concentrations determined from the analysis of the appropriate samples taken in accordance with Radiological Effluent Control 3/4.11.2.1, Table 4.11-2.

500 = Dose rate limit to the total body of an individual at or beyond the SITE BOUNDARY due to noble gases from all release sources. (mRem/yr)

3000 = Dose rate limit to the skin of the body of an individual at or beyond the SITE BOUNDARY due to noble gases from all release sources. (mRem/yr)

SF = Safety Factor of 0.5 applied to compensate for statistical fluctuations, errors of measurement, and non-uniform distribution of release activity between the stacks (unitless)

12

8

Then the release rate setpoint for each stack monitor, C_f , in uCi/sec is determined as follows:

8

$$C_f = Q_{\text{site}} \cdot AF \quad [\text{Eq. 2-7}]$$

Where: AF = Allocation Factor of 0.5 applied to account for releases from both plant stacks simultaneously (unitless). This factor will limit the release rate contribution from each stack to 1/2 the limit for the site.

2.2.2 Plant Vent Stack Noble Gas Activity Monitors

XRE-5570A/XRE-5570B (WRGM low range noble gas activity channel)
and XRE-5567A/XRE-5567B (PIG noble gas channel)

The WRGM low range noble gas activity channels provide noble gas concentration data to the effluent release rate channels, as discussed in Section 2.2.1 above. The monitor design does not include an alarm setpoint for this channel that provides an audible alarm if the setpoint is exceeded. Therefore, setpoint adjustments are not performed for these channels. Radiological Effluent Control 3/4.3.3.5, Table 3.3-8, ACTION 36 allows for use of the stack PIG noble gas monitors (XRE-5567A and XRE-5567B) as a backup for an inoperable WRGM effluent

release rate channel when no automatic control function is required. The alarm setpoint for these channels, C_G in $\mu\text{Ci}/\text{cm}^3$, is determined using the following methodology: 8

$$C_G = \frac{C_f}{F_{PVS}} \quad [\text{Eq. 2-8}] \quad 8$$

Where: F_{PVS} = the maximum stack flow rate (cc/sec) corresponding to 115,000 cfm during normal operations and 130,000 cfm during containment purges. 8

2.2.3 Sampler Flow Rate Monitors (X-RFT-5570A-1/B-1) 8

The WRGMs are designed to sample isokinetically from the plant vent stacks. Isokinetic sample flow is maintained automatically by the monitor microprocessor. The sampler flow rate monitors are designed such that if there is a loss of sample flow, the stack monitor automatic control functions are initiated. The loss of sample flow alarm setpoints are established permanently in accordance with vendor specifications. 8

2.2.4 Auxiliary Building Ventilation Exhaust Monitor (XRE-5701) 8

Radiological Effluent Control 3/4.3.3.5, Table 3.3-8, ACTION 34, allows for the Auxiliary Building Ventilation (ABV) Duct Monitor (XRE-5701) to be used as a backup for an inoperable WRGM for monitoring Waste Gas Decay Tank (WGDT) releases. XRE-5701 monitors WGDT releases by measuring activity in the Auxiliary Building Vent Duct and providing an automatic control function for termination of WGDT releases. If required, the alarm setpoint for XRE-5701 will be calculated using the following methodology. The alarm setpoint calculation is based on the following assumption: 8

- (1) a waste gas decay tank release is the only batch release occurring (i.e., a containment purge or vent is not occurring at the same time). 8

Based on assumption (1) above, there are a maximum of three release sources that may contribute to the total release rate from the site during a WGDT release. These are the WGDT batch release, the continuous release from Stack A, and the continuous release from Stack B. Therefore, a release factor of 1/3 will be used for the ABV monitor setpoint determination. The total release rate from the site at the alarm setpoint release rate from each stack would correspond to a value of $2C_f$ uCi/sec. To determine the ABV monitor setpoint, the release rate contribution from the ABV will be limited to 1/3 of the limiting site release rate:

8

$$Q_{aux} = 1/3 \cdot 2C_f = 2/3 C_f \quad [\text{Eq. 2-9}]$$

8

Where: Q_{aux} = Limiting release rate contribution from the Auxiliary Building Vent during WGDT releases (uCi/sec)

8

Other terms have been previously defined.

8

To determine the setpoint, C_{aux} , for the ABV monitor in uCi/cc, the limiting ABV release rate is divided by the Maximum ABV flow rate:

8

$$C_{aux} = \frac{Q_{aux}}{F_{aux}} = \frac{2C_f}{3F_{aux}} \quad [\text{Eq. 2-10}]$$

8

Where: F_{aux} = Maximum ABV flow rate (cc/sec) corresponding to 106,400 cfm.

8

2.2.5 Containment Atmosphere Gaseous Monitors (1RE-5503 and 2RE-5503)

8

For implementation of Technical Specification 3.3.6, the alarm setpoint for the Containment Atmosphere Gaseous Monitor for Containment Ventilation Isolation will be calculated using the following methodology. The alarm setpoint calculation is based on the following assumption:

16

(1) a purge or vent from each containment may occur simultaneously and no other batch release is occurring (i.e., a waste gas decay tank release is not occurring at the same time as a containment release).

8

Based on assumption (1) above, there are a maximum of four release sources that may contribute to the total release rate from the site during a containment release. These are a Unit 1 Containment release, a Unit 2 Containment release the continuous release from Stack A, and the continuous release from Stack B. Therefore, a release factor of 1/4 will be used for the the containment monitor setpoint determination. The total release rate from the site at the alarm setpoint release rate from each stack would correspond to a value of $2C_f$ uCi/sec. To determine the containment monitor setpoint, the release rate contribution from a containment release will be limited to 1/4 of the limiting site release rate:

8

$$Q_{\text{cont}} = \frac{1}{4} \cdot 2 C_f = \frac{1}{2} C_f \quad [\text{Eq. 2-11}]$$

Where: Q_{cont} = the limiting release rate contribution from a containment release (uCi/sec)

8

Other terms have been previously defined.

8

To determine the setpoint, C_{cont} , for the containment monitor in uCi/cc, the limiting containment release rate is divided by the maximum containment release flow rate:

8

$$C_{\text{cont}} = \frac{Q_{\text{cont}}}{F_{\text{cont}}} = \frac{C_f}{2 F_{\text{cont}}} \quad [\text{Eq. 2-12}]$$

Where: F_{cont} = the maximum containment release flow rate (cc/sec) corresponding to 750 cfm for containment vents and 30,000 cfm for containment purges.

8

2.3 DOSE CALCULATIONS FOR GASEOUS EFFLUENTS

The methodologies for calculating doses from gaseous effluents are given in Sections 2.3.1 and 2.3.2 below. For purposes of demonstrating compliance with the dose limits of Radiological Effluent Controls 3.11.2.2 and 3.11.2.3, the calculated cumulative doses (i.e., the total dose for both units) will be compared to two times the dose limits for a unit. In other words, the doses assigned to each unit will be one-half the total doses from all releases from the site.

2.3.1 Dose Due to Noble Gases

For implementation of Radiological Effluent Control 3/4.11.2.2, the cumulative air dose due to noble gases to areas at and beyond the SITE BOUNDARY will be calculated at least once per 31 days and a cumulative summation of the air doses will be maintained for each calendar quarter and each calendar year. The air dose over the desired time period will be calculated as follows:

A. Air Dose Due to Gamma Emissions

D_{γ} = air dose due to gamma emissions from noble gas radionuclides from all release sources (mrad)

$$D_{\gamma} = 3.17 \times 10^{-8} (\overline{X/Q}) \sum (\text{noble gases}) M_i Q'_i \quad [\text{Eq. 2-13}]$$

Where: 3.17×10^{-8} = the fraction of a year represented by one second

Q'_i = the cumulative release of radionuclide i during the period of interest from all release sources (uCi)

($Q'_i = Q_i$ (uCi/sec) x release duration (sec))

Q'_i is based on the noble gas activities in each plant vent stack and WGDT or Containment Samples required by Radiological Effluent Control 3/4.11.2.1, Table 4.11-2.

8

All other variables are previously defined.

B. Air Dose Due to Beta Emissions

8

D_β = Air dose due to beta emissions from noble gas radionuclides. (mrad)

$$D_\beta = 3.17 \times 10^{-8} (\overline{X/Q}) \sum_{(noble\ gases)} N_i Q'_i \quad [Eq.2-14]$$

Where: N_i = Air dose factor due to beta emissions from noble gas radionuclide i from Table 2.2.
(mRad/yr per uCi/m³).

All other variables are previously defined.

NOTE: If the methodology in this section is used in determining dose to an individual rather than air dose due to noble gases, substitute K_i for M_i , $(L_i + 1.1 M_i)$ for N_i , and the Annual Average X/Q values from information listed and maintained current in the results of the annual Land Use Census for the highest annual average relative concentration $(\overline{X/Q})$ at the SITE BOUNDARY.

12

2.3.2. Dose Due to Radioiodines, Tritium, and Particulates

8

For implementation of Radiological Effluent Control 3/4.11.2.3, the cumulative dose to each organ of an individual due to iodine-131, iodine-133, tritium, and particulates with half-lives greater than 8 days will be calculated at least once per 31 days and a cumulative summation of these doses will be maintained for each calendar quarter and each calendar year. The dose over the desired period will be calculated as follows:

$$D_p = \sum_{paths} 3.17 \times 10^{-8} W' \sum_{I\&PT} R^p_{i,a,o} Q'_i \quad [Eq.2-15]$$

Where:	$D_p =$	Dose due to all real pathways to organ, o, of an individual in age group, a, from iodine-131, iodine-133, tritium, and radionuclides in particulate form with half-lives greater than eight days from all release sources (mRem).	8
	$W' =$	Dispersion parameter for estimating the dose to an individual at the location where the combination of existing pathways and receptor age groups indicates the maximum potential exposures. Locations of interest are listed in the results of the annual Land Use Census.	12
	$W' =$	X/Q for the inhalation pathway in sec/m^3 . X/Q is the annual average relative concentration at the location of interest. Values for X/Q are listed in the results of the annual Land Use Census. If desired, the highest individual receptor X/Q or $\overline{X/Q}$ value may be used, or	8 12 8
	$W' =$	D/Q for the food and ground plane pathways in m^{-2} . D/Q is the annual average deposition at the location of interest. Values for D/Q are listed in the results of the annual Land Use Census. If desired, the highest individual receptor D/Q or $\overline{D/Q}$ value may be used.	12 8
	NOTE:	For tritium, the dispersion parameter, W' is taken as the annual average X/Q values from information listed and maintained current in the results of the annual Land Use Census for inhalation, food and ground plane pathways.	12
	$R_{i,a,o}^p =$	Dose factor for radionuclide i, pathway p, age group a and organ o, in mRem/yr per uCi/ m^3 for the inhalation pathway and m^2 (mRem/yr) per uCi/sec for food and ground plane pathways, except for tritium which is in mRem/yr per uCi/ m^3 for all pathways. The values for $R_{i,a,o}^p$ for each pathway, radionuclide, age group and organ are listed in Table 2.4.	8

The methodologies used for determining values of $R_{i,a,o}^p$ for each pathway are given in Appendices B through F.

Q'_i = Cumulative release of radionuclide, i , during the period of interest (uCi). Q'_i is based on the activities measured in each plant vent stack from the analyses of the particulate and iodine samples required by Radiological Effluent Control 3/4.11.2.1, Table 4.11-2.

I&PT = Iodines, particulates with half-lives greater than eight days, and tritium. These are the isotopes over which the summation function is to be performed.

PATHS = The real pathways of exposure to individuals at the locations of interest.

2.4 DOSE PROJECTIONS FOR GASEOUS EFFLUENTS

Radiological Effluent Control 3/4.11.2.4 requires that appropriate portions of the PRIMARY PLANT VENTILATION SYSTEM and WASTE GAS HOLDUP SYSTEM be used to reduce releases of radioactivity when the projected doses due to the gaseous effluent from a unit to areas at or beyond the SITE BOUNDARY would exceed, in a 31-day period, either:

- 0.2 mrad to air from gamma radiation; or
- 0.4 mrad to air from beta radiation; or
- 0.3 mrem to any organ of a MEMBER OF THE PUBLIC.

The following calculational method is provided for performing this dose projection:

At least once every 31 days the gamma air dose, beta air dose and the maximum organ dose for each unit for the previous three months will be divided by the number of days in the three month period and multiplied by 31. Also, this dose projection may

8 include the estimated dose due to any anticipated unusual releases during the period for which the projection is made, such as Waste Gas Decay Tank release. If the projected doses for a unit exceed any of the values listed above, appropriate portions of the PRIMARY PLANT VENTILATION SYSTEM and WASTE GAS HOLDUP SYSTEM shall be used to reduce radioactivity levels prior to release.

8 2.5 DOSE CALCULATIONS TO SUPPORT OTHER REQUIREMENTS

10 For the purpose of implementing the requirements of Radiological Effluent Control 6.9.1.4, the Annual Radioactive Effluent Release Report shall include an assessment of the radiation doses due to radioactive liquid and gaseous effluents from the station during the previous year of operation. This assessment shall be a summary of the doses determined in accordance with Section 1.3 for doses due to liquid effluents, Section 2.3.1 for air doses due to noble gases, and Section 2.3.2 for doses due to iodines, tritium, and particulates. This same report shall also include an assessment of the radiation doses from radioactive liquid and gaseous effluents to members of the public due to their activities inside the SITE BOUNDARY. This assessment shall be performed in accordance with the methodologies in Sections 1.3, 2.3.1, and 2.3.2, using either historical average or concurrent dispersion and deposition parameters for the locations of interest, and taking into account occupancy factors. All assumptions and factors used in the determination shall be included in the report.

8 For the purpose of implementing Radiological Effluent Control 3/4.12.2 dose calculations for the new locations identified in the land use census shall be performed using the methodology in Section 2.3.2, substituting the appropriate pathway receptor dose factors and dispersion parameters for the location(s) of interest. Annual average dispersion parameters may be used for these calculations. If the land use census changes, the critical location (i.e., the location where an individual would be exposed to the highest dose) must be reevaluated for the nearest residence, the nearest milk animal, and the nearest

2
0 | vegetable garden. Additionally, when a location is identified that yields a calculated dose 20% greater than at a location where environmental samples are currently being obtained, add the new location within 30 days to the Radiological Environmental Monitoring locations described in Section 3.1 of this manual.

8 | For the purpose of implementing Radiological Effluent Control 3/4.11.4, the total annual dose to any member of the public due to releases of radioactivity and to radiation from uranium fuel cycle sources may be determined by summing the annual doses determined for a member of the public in accordance with the methodology of Sections 1.3, 2.3.1, and 2.3.2 and the direct radiation dose contributions from the units and from outside storage tanks to the particular member of the public. This assessment must be performed in the event calculated doses from the effluent releases exceed twice the limits of Controls 3/4.11.1.2, 3/4.11.2.2, or 3/4.11.2.3. This assessment will be included in the Annual Radioactive Effluent Release Report to be submitted the year after the assessment was required. Otherwise, no assessments are required.

8 | For the evaluation of doses to real individuals from liquid releases, the same calculation methods as employed in Section 1.3 will be used. However, more encompassing and realistic assumptions will be made concerning the dilution and ingestion of radionuclides. The results of the Radiological Environmental Monitoring Program will be used in determining the realistic dose based on actual measured radionuclide concentrations. For the evaluation of doses to real individuals from gaseous releases, the same calculational methods as employed in Sections 2.3.1 and 2.3.2 will be used. In Section 2.3.1, the total body dose factor should be substituted for the gamma air dose factor (M_1) to determine the total body dose. Otherwise, the same calculational sequence applies. More realistic assumptions will be made concerning the actual location of real individuals, the meteorological conditions, and the consumption of food. Data obtained from the latest land use census should be used to

determine locations for evaluating doses. The results of the Radiological Environmental Monitoring Program will be included in determining more realistic doses based on actual measured radionuclide concentrations.

8

The dose component due to direct radiation may be determined by calculation or actual measurement (e.g., thermoluminescent dosimeters, micro-R meter, etc.). The calculation or actual measurement of direct radiation shall be documented in the Special Report that must be submitted if this determination is required.

8

2.6 METEOROLOGICAL MODEL

8

2.6.1 Dispersion Calculations

8

Atmospheric dispersion for gaseous releases is calculated using a straight line flow Gaussian model similar to the Constant Mean Wind Direction model given in Regulatory Guide 1.111, Section C.1.c. The method given here is modified by including factors to account for plume depletion and effects of the open terrain. The average relative concentration is given by the following equation:

8

$$\frac{X}{Q} = 2.032 \delta K \sum_{j,k} \left(\frac{n_{jk}}{N r \bar{u}_{jk} \sum_j (r)} \right) \quad [\text{Eq. 2-16}]$$

Where:

X/Q = average concentration normalized by source strength (sec/m^3).

8

$2.032 = (2/\pi)^{1/2} \cdot (2\pi/16)^{-1}$.

8

δ = plume depletion factor at distance r for the applicable stability class (Figure 2.2). Normally, a value of 1.0 is assumed when undepleted X/Q values are to be used in dose calculations.

8

K = terrain correction factor (Figure 2.5) | 8
 n_{jk} = the number of hours meteorological conditions are observed to be in a given wind direction, wind speed class, k, and atmospheric stability class, j.
 N = total hours of valid meteorological data throughout the period of release.

NOTE: If hourly meteorological data are used, all variable subscripts are dropped, n_{jk} and N are set equal to 1, and the hourly averaged meteorological variables are used in the model. | 8

r = downwind distance from the release point to the location of interest (meters) | 8

\bar{u}_{jk} = the average windspeed (midpoint of windspeed class, k) measured at the 10 meter level during stability class j. (meters/sec) | 8

$\Sigma_j(r)$ = the vertical plume spread with a volumetric correction for a release within the building wake cavity, at a distance, r, for stability class, j, expressed in meters. | 8

NOTE: All parameters are considered dimensionless unless otherwise indicated. | 8

The equation for calculating $\Sigma_j(r)$ is: | 8

$$\Sigma_j(r) = \text{the lesser of } \begin{cases} (\sigma_j^2 + 0.5 b^2/\pi)^{\frac{1}{2}} & \text{[Eq. 2-17]} \\ \sqrt{3} \sigma_j & \text{[Eq. 2-18]} \end{cases}$$

Where:

σ_j = the vertical standard deviation of materials in the plume at distance, r, for atmospheric stability class, j, expressed in meters (Figure 2.3) | 8

0.5 = the building shape factor. | 8
b = the vertical height of the reactor | 8
containment structure (79.4 meters) |

2.6.2 Deposition Calculations | 8

The relative deposition per unit area is calculated as follows: | 8

$$\frac{D}{Q} = \frac{K D_g z}{0.3927 r} \quad [\text{Eq. 2-19}]$$

Where:

D/Q = deposition per unit area normalized by | 8
source strength (m⁻²) |
D_g = relative deposition rate for a ground level | 8
release (m⁻¹) (Figure 2.4) |
z = the fraction of time the wind blows to the | 8
sector of interest. |

NOTE: If hourly meteorological data are used, z is set equal to | 8
one. |

0.3927 = the width in radians of a 22.5° sector. | 8

Other variables are as previously defined. | 8

NOTE: All parameters are considered dimensionless unless | 8
otherwise indicated. |

2.7 DEFINITIONS OF GASEOUS EFFLUENTS PARAMETERS

8

<u>Term</u>	<u>Definition</u>	
AF	Allocation Factor of 0.5 applied to account for releases from both stacks simultaneously. This factor will limit the release rate contribution from each stack to 1/2 the limit for the site	8
B	vertical height of the reactor containment structure	
C _G	the alarm setpoint for each plant vent stack noble gas activity monitor (uCi/cm ³)	8
C _f	the alarm setpoint for each plant vent stack effluent release rate monitor (uCi/sec)	
C _{aux}	the Auxiliary Building Ventilation Exhaust monitor alarm setpoint (uCi/cm ³)	
C _{cont}	the Containment Atmosphere Gaseous monitor alarm setpoint (uCi/cm ³)	8
D _g	relative deposition rate for a ground-level release (m ⁻¹)	
D _O	the total organ dose rate due to tritium, iodines, and particulates with half-lives greater than eight days from all gaseous release sources (mRem/yr)	8
D _{OV}	the organ dose rate due to tritium, iodines, and particulates with half-lives greater than eight days from gaseous release source v (mRem/yr)	8
D _p	dose to any organ of an individual from radioiodines, tritium and radionuclides in particulate form with half-lives greater than eight days from all release sources (mRem)	8

<u>Term</u>	<u>Definition</u>	
D_s	Skin dose rate at the SITE BOUNDARY due to noble gases from all release sources. (mRem/yr)	8
D_{sv}	Skin dose rate at the SITE BOUNDARY due to noble gases from release source v. (mRem/yr)	8
D_t	Total body dose rate at the SITE BOUNDARY due to noble gases from all release sources. (mRem/yr)	8
D_{tv}	Total body dose rate at the SITE BOUNDARY due to noble gases from release source v. (mRem/yr)	8
D_β	Air dose due to beta emissions from noble gases from all release sources. (mRad)	8
D_γ	Air dose due to gamma emissions from noble gases from all release sources. (mRad)	8
D/Q	Annual average relative deposition at the location of interest. (m^{-2})	
δ	Plume depletion factor at distance r for the appropriate stability class (radioiodines and particulates).	8
F_v	Flow rate from each release source v. (cm^3/sec)	8
F_{aux}	Maximum Auxiliary Building Ventilation flow rate (cm^3/sec) corresponding to 106,400 cfm.	8
F_{cont}	Maximum containment release flow rate (cm^3/sec) corresponding to 750 cfm for containment vents and 30,000 cfm for containment purges.	8
F_{pvs}	Maximum stack flow rate (cc/sec) corresponding to 115,000 cfm during normal operations and 130,000 cfm during containment purges.	8

<u>Term</u>	<u>Definition</u>	
K	terrain recirculation factor (Unitless)	8
K_i	total body dose factor due to gamma emissions from noble gas radionuclide i (mRem/yr per uCi/m ³)	8
L_i	skin dose factor due to beta emissions from noble gas radionuclide i (mRem/yr per uCi/m ³)	8
M_i	air dose factor due to gamma emissions from noble gas radionuclide i (mRem/yr per uCi/m ³)	8
N_i	air dose factor due to beta emissions from noble gas radionuclide i (mRem/yr per uCi/m ³)	8
n_{jk}	number of hours meteorological conditions are observed to be in a given wind direction, wind speed class k, and atmospheric stability class j	8
N	total hours of valid meteorological data	8
P_i	pathway dose rate parameter for radionuclide i, (other than noble gases) for the inhalation pathway (mRem/yr per uCi/cm ³)	8
Q_{aux}	the limiting release rate contribution from the Auxiliary Building Vent during WGD releases (uCi/sec)	8
Q_{cont}	the limiting release rate contribution from a containment release (uCi/sec)	8
Q_i	total release rate of radionuclide i from all release sources (uCi/sec)	8

Term Definition

Q_{iv}	Total release rate of radionuclide i from release source v. (uCi/sec)
Q'_i	Cumulative release of radionuclide i during the period of interest from all release sources. (uCi)
Q_{NG}	Actual release rate of noble gases from all release sources as calculated from the radionuclide concentrations determined from analyses of samples taken in accordance with Control 3/4.11.2.1, Table 4.11-2.
Q_{SITE}	Total site noble gas release rate limit corresponding to a dose rate at or beyond the SITE BOUNDARY of 500 mRem/yr to the total body or 3000 mRem/yr to the skin. (uCi/sec)
$RP_{i,a,o}$	Dose factor for radionuclide i, pathway p, and age group a, and organ o (mRem/yr per uCi/m ³) or(m ² -mRem/yr per uCi/sec).
r	Distance from the point of release to the location of interest for dispersion calculations. (meters)
SF	Safety Factor of 0.5 applied to compensate for statistical fluctuations, errors of measurement, and non-uniform distribution of release activity between the stacks.
$\Sigma_j(r)$	Vertical plume spread with a volumetric correction for a release within the building wake cavity, at a distance, r, for stability class, j, expressed in meters.
σ_j	Vertical standard deviation of the plume concentration (in meters), at distance, r, for stability category j.
\bar{u}_{jk}	Wind speed (midpoint of windspeed class k) at ground level (m/sec) during atmosphere stability class j.

Term Definition

8

W' Dispersion parameter for estimating the dose to an individual at the location where the combination of existing pathways and receptor age groups indicates the maximum exposures.

X/Q Annual average relative concentration at the location of interest.
(sec/m³)

$\overline{X/Q}$ Highest annual average relative concentration at the SITE BOUNDARY.
(sec/m³) (3.3 x 10⁻⁶ sec/m³ in the NNW sector)

X_{iv} Measured concentration of radionuclide i present in each release source v. (uCi/cm³).

z Fraction of time the wind blows to the sector of interest.

8

1.1 Conversion factor of mRem skin dose per mRad air dose.

500 Dose rate limit to the total body of an individual at or beyond the SITE BOUNDARY due to noble gases from all release sources. (mRem/yr)

12

3000 Dose rate limit to the skin of the body of the individual at or beyond the SITE BOUNDARY due to noble gases from all release sources.
(mRem/yr)

DOSE FACTORS FOR EXPOSURE TO A SEMI-INFINITE CLOUD OF NOBLE GASES*

Isotope	γ -Body***(K)	β -Skin***(L)	γ -Air**(M)	β -Air**(N)
Kr-83m	7.56E-02	---	1.93E+01	2.88E+02
Kr-85m	1.17E+03	1.46E+03	1.23E+03	1.97E+03
Kr-85	1.61E+01	1.34E+03	1.72E+01	1.95E+03
Kr-87	5.92E+03	9.73E+03	6.17E+03	1.03E+04
Kr-88	1.47E+04	2.37E+03	1.52E+04	2.93E+03
Kr-89	1.66E+04	1.01E+04	1.73E+04	1.06E+04
Kr-90	1.56E+04	7.29E+03	1.63E+04	7.83E+03
Xe-131m	9.15E+01	4.76E+02	1.56E+02	1.11E+03
Xe-133m	2.51E+02	9.94E+02	3.27E+02	1.48E+03
Xe-133	2.94E+02	3.06E+02	3.53E+02	1.05E+03
Xe-135m	3.12E+03	7.11E+02	3.36E+03	7.39E+02
Xe-135	1.81E+03	1.86E+03	1.92E+03	2.46E+03
Xe-137	1.42E+03	1.22E+04	1.51E+03	1.27E+04
Xe-138	8.83E+03	4.13E+03	9.21E+03	4.75E+03
Ar-41	8.84E+03	2.69E+03	9.30E+03	3.28E+03

*Values taken from Reference 2, Table B-1

** $\frac{\text{mrad-m}^3}{\text{uCi-yr}}$

*** $\frac{\text{rem-m}^3}{\text{uCi-yr}}$

TABLE 23
PATHWAY DOSE RATE PARAMETER (P1)*

*BASED ON THE INHALATION PATHWAY
FOR THE CHILD AGE GROUP

NUCLIDE	ORGAN DOSE FACTORS						
	BONE	LIVER	T. BODY	THYROID	KIDNEY	LUNG	GI-LLI
H-3	0.00E+00	1.12E+03	1.12E+03	1.12E+03	1.12E+03	1.12E+03	1.12E+03
P-32	2.60E+06	1.14E+05	9.88E+04	0.00E+00	0.00E+00	0.00E+00	4.22E+04
CR-51	0.00E+00	0.00E+00	1.54E+02	8.55E+01	2.43E+01	1.70E+04	1.08E+03
MN-54	0.00E+00	4.29E+04	9.51E+03	0.00E+00	1.00E+04	1.58E+06	2.29E+04
FE-55	4.74E+04	2.52E+04	7.77E+03	0.00E+00	0.00E+00	1.11E+05	2.87E+03
FE-59	2.07E+04	3.34E+04	1.67E+04	0.00E+00	0.00E+00	1.27E+06	7.07E+04
CO-58	0.00E+00	1.77E+03	3.16E+03	0.00E+00	0.00E+00	1.11E+06	3.44E+04
CO-60	0.00E+00	1.31E+04	2.26E+04	0.00E+00	0.00E+00	7.07E+06	9.62E+04
NI-63	8.21E+05	4.63E+04	2.80E+04	0.00E+00	0.00E+00	2.75E+05	6.33E+03
ZN-65	4.26E+04	1.13E+05	7.03E+04	0.00E+00	7.14E+04	9.95E+05	1.63E+04
RB-86	0.00E+00	1.98E+05	1.14E+05	0.00E+00	0.00E+00	0.00E+00	7.99E+03
SR-89	5.99E+05	0.00E+00	1.72E+04	0.00E+00	0.00E+00	2.16E+06	1.67E+05
SR-90	1.01E+08	0.00E+00	6.44E+06	0.00E+00	0.00E+00	1.48E+07	3.43E+05
Y-91	9.14E+05	0.00E+00	2.44E+04	0.00E+00	0.00E+00	2.63E+06	1.84E+05
ZR-95	1.90E+05	4.18E+04	3.70E+04	0.00E+00	5.96E+04	2.23E+06	6.11E+04
NB-95	2.35E+04	9.18E+03	6.55E+03	0.00E+00	8.62E+03	6.14E+05	3.70E+04
RU-103	2.79E+03	0.00E+00	1.07E+03	0.00E+00	7.03E+03	6.62E+05	4.48E+04
RU-106	1.36E+05	0.00E+00	1.69E+04	0.00E+00	1.84E+05	1.43E+07	4.29E+05
AG-110M	1.69E+04	1.14E+04	9.14E+03	0.00E+00	2.12E+04	5.48E+06	1.00E+05
TE-125M	6.73E+03	2.33E+03	9.14E+02	1.92E+03	0.00E+00	4.77E+05	3.38E+04
TE-127M	2.49E+04	8.55E+03	3.02E+03	6.07E+03	6.36E+04	1.48E+06	7.14E+04
TE-129M	1.92E+04	6.85E+03	3.04E+03	6.33E+03	5.03E+04	1.76E+06	1.82E+05
I-131	4.81E+04	4.81E+04	2.73E+04	1.62E+07	7.88E+04	0.00E+00	2.84E+03
I-133	1.66E+04	2.03E+04	7.70E+03	3.85E+06	3.38E+04	0.00E+00	5.48E+03
CS-134	6.51E+05	1.01E+06	2.25E+05	0.00E+00	3.30E+05	1.21E+05	3.85E+03
CS-136	6.51E+04	1.71E+05	1.16E+05	0.00E+00	9.55E+04	1.45E+04	4.18E+03
CS-137	9.07E+05	8.25E+05	1.28E+05	0.00E+00	2.82E+05	1.04E+05	3.62E+03
BA-140	7.40E+04	6.48E+01	4.33E+03	0.00E+00	2.11E+01	1.74E+06	1.02E+05
CE-141	3.92E+04	1.95E+04	2.90E+03	0.00E+00	8.55E+03	5.44E+05	5.66E+04
CE-144	6.77E+06	2.12E+06	3.61E+05	0.00E+00	1.17E+06	1.20E+07	3.89E+05
PR-143	1.85E+04	5.55E+03	9.14E+02	0.00E+00	3.00E+03	4.33E+05	9.73E+04
ND-147	1.08E+04	8.73E+03	6.81E+02	0.00E+00	4.81E+03	3.28E+05	8.21E+04

TABLE 2.4
PATHWAY DOSE FACTORS

AGE GROUP: ALL

PATHWAY: GROUND PLANE

NUCLIDE	ORGAN DOSE FACTORS	
	T. BODY	SKIN
H-3	0.00E+00	0.00E+00
P-32	0.00E+00	0.00E+00
CR-51	4.65E+06	5.50E+06
MN-54	1.39E+09	1.62E+09
FE-55	0.00E+00	0.00E+00
FE-59	2.73E+08	3.21E+08
CO-58	3.79E+08	4.44E+08
CO-60	2.15E+10	2.53E+10
NI-63	0.00E+00	0.00E+00
ZN-65	7.47E+08	8.59E+08
RB-86	8.97E+06	1.03E+07
SR-89	2.16E+04	2.51E+04
SR-90	0.00E+00	0.00E+00
Y-91	1.07E+06	1.21E+06
ZR-95	2.45E+08	2.84E+08
NB-95	1.37E+08	1.61E+08
RU-103	1.08E+08	1.26E+08
RU-106	4.22E+08	5.06E+08
AG-110M	3.44E+09	4.01E+09
TE-125M	1.55E+06	2.13E+06
TE-127M	9.17E+04	1.08E+05
TE-129M	1.98E+07	2.31E+07
I-131	1.72E+07	2.09E+07
I-133	2.45E+06	2.98E+06
CS-134	6.86E+09	8.00E+09
CS-136	1.51E+08	1.71E+08
CS-137	1.03E+10	1.20E+10
BA-140	2.06E+07	2.36E+07
CE-141	1.37E+07	1.54E+07
CE-144	6.96E+07	8.05E+07
PR-143	0.00E+00	0.00E+00
ND-147	8.39E+06	1.01E+07

TABLE 2.4
PATHWAY DOSE FACTORS

AGE GROUP: ADULT PATHWAY: GRASS-COW-MILK

NUCLIDE	ORGAN DOSE FACTORS						
	BONE	LIVER	T. BODY	THYROID	KIDNEY	LUNG	GI-LLI
H-3	0.00E+00	7.62E+02	7.62E+02	7.62E+02	7.62E+02	7.62E+02	7.62E+02
P-32	1.70E+10	1.06E+09	6.58E+08	0.00E+00	0.00E+00	0.00E+00	1.91E+09
CR-51	0.00E+00	0.00E+00	2.85E+04	1.70E+04	6.28E+03	3.78E+04	7.17E+06
MN-54	0.00E+00	8.40E+06	1.60E+06	0.00E+00	2.50E+06	0.00E+00	2.57E+07
FE-55	2.51E+07	1.73E+07	4.04E+06	0.00E+00	0.00E+00	9.66E+06	9.93E+06
FE-59	2.97E+07	6.97E+07	2.67E+07	0.00E+00	0.00E+00	1.95E+07	2.32E+08
CO-58	0.00E+00	4.71E+06	1.05E+07	0.00E+00	0.00E+00	0.00E+00	9.54E+07
CO-60	0.00E+00	1.64E+07	3.61E+07	0.00E+00	0.00E+00	0.00E+00	3.08E+08
NI-63	6.72E+09	4.65E+08	2.25E+08	0.00E+00	0.00E+00	0.00E+00	9.71E+07
ZN-65	1.37E+09	4.36E+09	1.97E+09	0.00E+00	2.91E+09	0.00E+00	2.74E+09
RB-86	0.00E+00	2.59E+09	1.21E+09	0.00E+00	0.00E+00	0.00E+00	5.10E+08
SR-89	1.45E+09	0.00E+00	4.16E+07	0.00E+00	0.00E+00	0.00E+00	2.32E+08
SR-90	4.67E+10	0.00E+00	1.15E+10	0.00E+00	0.00E+00	0.00E+00	1.35E+09
Y-91	8.57E+03	0.00E+00	2.29E+02	0.00E+00	0.00E+00	0.00E+00	4.72E+06
ZR-95	9.41E+02	3.02E+02	2.04E+02	0.00E+00	4.74E+02	0.00E+00	9.57E+05
NB-95	8.24E+04	4.58E+04	2.46E+04	0.00E+00	4.53E+04	0.00E+00	2.78E+08
RU-103	1.02E+03	0.00E+00	4.38E+02	0.00E+00	3.88E+03	0.00E+00	1.19E+05
RU-106	2.04E+04	0.00E+00	2.58E+03	0.00E+00	3.93E+04	0.00E+00	1.32E+06
AG-110M	5.81E+07	5.38E+07	3.19E+07	0.00E+00	1.06E+08	0.00E+00	2.19E+10
TE-125M	1.63E+07	5.89E+06	2.18E+06	4.89E+06	6.61E+07	0.00E+00	6.49E+07
TE-127M	4.57E+07	1.63E+07	5.57E+06	1.17E+07	1.86E+08	0.00E+00	1.53E+08
TE-129M	6.01E+07	2.24E+07	9.51E+06	2.06E+07	2.51E+08	0.00E+00	3.02E+08
I-131	2.96E+08	4.23E+08	2.42E+08	1.39E+11	7.25E+08	0.00E+00	1.12E+08
I-133	3.87E+06	6.73E+06	2.05E+06	9.88E+08	1.17E+07	0.00E+00	6.04E+06
CS-134	5.64E+09	1.34E+10	1.10E+10	0.00E+00	4.34E+09	1.44E+09	2.35E+08
CS-136	2.63E+08	1.04E+09	7.48E+08	0.00E+00	5.78E+08	7.92E+07	1.18E+08
CS-137	7.37E+09	1.01E+10	6.60E+09	0.00E+00	3.42E+09	1.14E+09	1.95E+08
BA-140	2.69E+07	3.38E+04	1.76E+06	0.00E+00	1.15E+04	1.94E+04	5.54E+07
CE-141	4.84E+03	3.27E+03	3.71E+02	0.00E+00	1.52E+03	0.00E+00	1.25E+07
CE-144	3.57E+05	1.49E+05	1.92E+04	0.00E+00	8.85E+04	0.00E+00	1.21E+08
PR-143	1.57E+02	6.32E+01	7.81E+00	0.00E+00	3.65E+01	0.00E+00	6.90E+05
ND-147	9.40E+01	1.09E+02	6.50E+00	0.00E+00	6.35E+01	0.00E+00	5.22E+05

TABLE 2.4
PATHWAY DOSE FACTORS

AGE GROUP: TEEN		PATHWAY: GRASS-COW-MILK					
NUCLIDE	ORGAN DOSE FACTORS						
	BONE	LIVER	T. BODY	THYROID	KIDNEY	LUNG	GI-LLI
H-3	0.00E+00	9.93E+02	9.93E+02	9.93E+02	9.93E+02	9.93E+02	9.93E+02
P-32	3.15E+10	1.95E+09	1.22E+09	0.00E+00	0.00E+00	0.00E+00	2.65E+09
CR-51	0.00E+00	0.00E+00	4.99E+04	2.77E+04	1.09E+04	7.13E+04	8.39E+06
MN-54	0.00E+00	1.40E+07	2.78E+06	0.00E+00	4.19E+06	0.00E+00	2.88E+07
FE-55	4.46E+07	3.16E+07	7.37E+06	0.00E+00	0.00E+00	2.01E+07	1.37E+07
FE-59	5.19E+07	1.21E+08	4.68E+07	0.00E+00	0.00E+00	3.82E+07	2.86E+08
CO-58	0.00E+00	7.94E+06	1.83E+07	0.00E+00	0.00E+00	0.00E+00	1.10E+08
CO-60	0.00E+00	2.78E+07	6.27E+07	0.00E+00	0.00E+00	0.00E+00	3.62E+08
NI-63	1.18E+10	8.36E+08	4.01E+08	0.00E+00	0.00E+00	0.00E+00	1.33E+08
ZN-65	2.11E+09	7.32E+09	3.42E+09	0.00E+00	4.69E+09	0.00E+00	3.10E+09
RB-86	0.00E+00	4.73E+09	2.22E+09	0.00E+00	0.00E+00	0.00E+00	7.00E+08
SR-89	2.68E+09	0.00E+00	7.67E+07	0.00E+00	0.00E+00	0.00E+00	3.19E+08
SR-90	6.62E+10	0.00E+00	1.63E+10	0.00E+00	0.00E+00	0.00E+00	1.86E+09
Y-91	1.58E+04	0.00E+00	4.24E+02	0.00E+00	0.00E+00	0.00E+00	6.48E+06
ZR-95	1.65E+03	5.21E+02	3.58E+02	0.00E+00	7.65E+02	0.00E+00	1.20E+06
NB-95	1.41E+05	7.82E+04	4.30E+04	0.00E+00	7.58E+04	0.00E+00	3.34E+08
RU-103	1.81E+03	0.00E+00	7.75E+02	0.00E+00	6.39E+03	0.00E+00	1.51E+05
RU-106	3.76E+04	0.00E+00	4.73E+03	0.00E+00	7.24E+04	0.00E+00	1.80E+06
AG-110M	9.64E+07	9.12E+07	5.55E+07	0.00E+00	1.74E+08	0.00E+00	2.56E+10
TE-125M	3.01E+07	1.08E+07	4.02E+06	8.40E+06	0.00E+00	0.00E+00	8.87E+07
TE-127M	8.45E+07	3.00E+07	1.00E+07	2.01E+07	3.42E+08	0.00E+00	2.11E+08
TE-129M	1.10E+08	4.09E+07	1.74E+07	3.56E+07	4.61E+08	0.00E+00	4.14E+08
I-131	5.38E+08	7.53E+08	4.05E+08	2.20E+11	1.30E+09	0.00E+00	1.49E+08
I-133	7.08E+06	1.20E+07	3.66E+06	1.68E+09	2.11E+07	0.00E+00	9.09E+06
CS-134	9.83E+09	2.31E+10	1.07E+10	0.00E+00	7.35E+09	2.81E+09	2.88E+08
CS-136	4.49E+08	1.77E+09	1.19E+09	0.00E+00	9.63E+08	1.52E+08	1.42E+08
CS-137	1.34E+10	1.78E+10	6.21E+09	0.00E+00	6.06E+09	2.36E+09	2.54E+08
BA-140	4.87E+07	5.97E+04	3.14E+06	0.00E+00	2.02E+04	4.01E+04	7.51E+07
CE-141	8.89E+03	5.94E+03	6.82E+02	0.00E+00	2.80E+03	0.00E+00	1.70E+07
CE-144	6.59E+05	2.73E+05	3.54E+04	0.00E+00	1.63E+05	0.00E+00	1.66E+08
PR-143	2.90E+02	1.16E+02	1.44E+01	0.00E+00	6.73E+01	0.00E+00	9.55E+05
ND-147	1.81E+02	1.97E+02	1.18E+01	0.00E+00	1.16E+02	0.00E+00	7.12E+05

TABLE 2.4
PATHWAY DOSE FACTORS

AGE GROUP: CHILD		PATHWAY: GRASS-COW-MILK					
NUCLIDE	ORGAN DOSE FACTORS						
	BONE	LIVER	T. BODY	THYROID	KIDNEY	LUNG	GI-LLI
H-3	0.00E+00	1.57E+03	1.57E+03	1.57E+03	1.57E+03	1.57E+03	1.57E+03
P-32	7.77E+10	3.64E+09	3.00E+09	0.00E+00	0.00E+00	0.00E+00	2.15E+09
CR-51	0.00E+00	0.00E+00	1.02E+05	5.65E+04	1.54E+04	1.03E+05	5.40E+06
MN-54	0.00E+00	2.10E+07	5.59E+06	0.00E+00	5.89E+06	0.00E+00	1.76E+07
FE-55	1.12E+08	5.94E+07	1.84E+07	0.00E+00	0.00E+00	3.36E+07	1.10E+07
FE-59	1.20E+08	1.95E+08	9.70E+07	0.00E+00	0.00E+00	5.65E+07	2.03E+08
CO-58	0.00E+00	1.21E+07	3.72E+07	0.00E+00	0.00E+00	0.00E+00	7.08E+07
CO-60	0.00E+00	4.32E+07	1.27E+08	0.00E+00	0.00E+00	0.00E+00	2.39E+08
NI-63	2.97E+10	1.59E+09	1.01E+09	0.00E+00	0.00E+00	0.00E+00	1.07E+08
ZN-65	4.14E+09	1.10E+10	6.86E+09	0.00E+00	6.95E+09	0.00E+00	1.94E+09
RB-86	0.00E+00	8.78E+09	5.40E+09	0.00E+00	0.00E+00	0.00E+00	5.65E+08
SR-89	6.63E+09	0.00E+00	1.89E+08	0.00E+00	0.00E+00	0.00E+00	2.57E+08
SR-90	1.12E+11	0.00E+00	2.84E+10	0.00E+00	0.00E+00	0.00E+00	1.51E+09
Y-91	3.91E+04	0.00E+00	1.05E+03	0.00E+00	0.00E+00	0.00E+00	5.21E+06
ZR-95	3.84E+03	8.43E+02	7.51E+02	0.00E+00	1.21E+03	0.00E+00	8.80E+05
NB-95	3.18E+05	1.24E+05	8.86E+04	0.00E+00	1.16E+05	0.00E+00	2.29E+08
RU-103	4.29E+03	0.00E+00	1.65E+03	0.00E+00	1.08E+04	0.00E+00	1.11E+05
RU-106	9.25E+04	0.00E+00	1.15E+04	0.00E+00	1.25E+05	0.00E+00	1.44E+06
AG-110M	2.09E+08	1.41E+08	1.13E+08	0.00E+00	2.63E+08	0.00E+00	1.68E+10
TE-125M	7.39E+07	2.00E+07	9.85E+06	2.07E+07	0.00E+00	0.00E+00	7.13E+07
TE-127M	2.08E+08	5.61E+07	2.47E+07	4.98E+07	5.94E+08	0.00E+00	1.69E+08
TE-129M	2.72E+08	7.59E+07	4.22E+07	8.76E+07	7.98E+08	0.00E+00	3.31E+08
I-131	1.31E+09	1.31E+09	7.46E+08	4.34E+11	2.16E+09	0.00E+00	1.17E+08
I-133	1.72E+07	2.13E+07	8.05E+06	3.95E+09	3.55E+07	0.00E+00	8.58E+06
CS-134	2.27E+10	3.72E+10	7.85E+09	0.00E+00	1.15E+10	4.14E+09	2.01E+08
CS-136	1.01E+09	2.79E+09	1.80E+09	0.00E+00	1.49E+09	2.21E+08	9.80E+07
CS-137	3.23E+10	3.09E+10	4.56E+09	0.00E+00	1.01E+10	3.62E+09	1.93E+08
BA-140	1.18E+08	1.03E+05	6.86E+06	0.00E+00	3.35E+04	6.14E+04	5.96E+07
CE-141	2.19E+04	1.09E+04	1.62E+03	0.00E+00	4.79E+03	0.00E+00	1.36E+07
CE-144	1.63E+06	5.09E+05	8.67E+04	0.00E+00	2.82E+05	0.00E+00	1.33E+08
PR-143	7.18E+02	2.16E+02	3.56E+01	0.00E+00	1.17E+02	0.00E+00	7.75E+05
ND-147	4.45E+02	3.61E+02	2.79E+01	0.00E+00	1.98E+02	0.00E+00	5.71E+05

TABLE 2.4
PATHWAY DOSE FACTORS

AGE GROUP: INFANT PATHWAY: GRASS-COW-MILK

NUCLIDE	ORGAN DOSE FACTORS						
	BONE	LIVER	T. BODY	THYROID	KIDNEY	LUNG	GI-LLI
H-3	0.00E+00	2.38E+03	2.38E+03	2.38E+03	2.38E+03	2.38E+03	2.38E+03
P-32	1.60E+11	9.42E+09	6.21E+09	0.00E+00	0.00E+00	0.00E+00	2.17E+09
CR-51	0.00E+00	0.00E+00	1.61E+05	1.05E+05	2.30E+04	2.05E+05	4.70E+06
MN-54	0.00E+00	3.91E+07	8.85E+06	0.00E+00	8.65E+06	0.00E+00	1.43E+07
FE-55	1.35E+08	8.74E+07	2.34E+07	0.00E+00	0.00E+00	4.27E+07	1.11E+07
FE-59	2.25E+08	3.93E+08	1.55E+08	0.00E+00	0.00E+00	1.16E+08	1.88E+08
CO-58	0.00E+00	2.43E+07	6.06E+07	0.00E+00	0.00E+00	0.00E+00	6.05E+07
CO-60	0.00E+00	8.83E+07	2.08E+08	0.00E+00	0.00E+00	0.00E+00	2.10E+08
NI-63	3.50E+10	2.16E+09	1.21E+09	0.00E+00	0.00E+00	0.00E+00	1.08E+08
ZN-65	5.56E+09	1.91E+10	8.79E+09	0.00E+00	9.24E+09	0.00E+00	1.61E+10
RB-86	0.00E+00	2.23E+10	1.10E+10	0.00E+00	0.00E+00	0.00E+00	5.70E+08
SR-89	1.26E+10	0.00E+00	3.62E+08	0.00E+00	0.00E+00	0.00E+00	2.59E+08
SR-90	1.22E+11	0.00E+00	3.10E+10	0.00E+00	0.00E+00	0.00E+00	1.52E+09
Y-91	7.34E+04	0.00E+00	1.95E+03	0.00E+00	0.00E+00	0.00E+00	5.26E+06
ZR-95	6.81E+03	1.66E+03	1.18E+03	0.00E+00	1.79E+03	0.00E+00	8.27E+05
NB-95	5.94E+05	2.45E+05	1.41E+05	0.00E+00	1.75E+05	0.00E+00	2.07E+08
RU-103	8.68E+03	0.00E+00	2.90E+03	0.00E+00	1.81E+04	0.00E+00	1.06E+05
RU-106	1.91E+05	0.00E+00	2.38E+04	0.00E+00	2.25E+05	0.00E+00	1.45E+06
AG-110M	3.86E+08	2.82E+08	1.87E+08	0.00E+00	4.03E+08	0.00E+00	1.46E+10
TE-125M	1.51E+08	5.05E+07	2.04E+07	5.08E+07	0.00E+00	0.00E+00	7.19E+07
TE-127M	4.22E+08	1.40E+08	5.10E+07	1.22E+08	1.04E+09	0.00E+00	1.70E+08
TE-129M	5.58E+08	1.91E+08	8.59E+07	2.14E+08	1.39E+09	0.00E+00	3.33E+08
I-131	2.72E+09	3.21E+09	1.41E+09	1.05E+12	3.75E+09	0.00E+00	1.15E+08
I-133	3.63E+07	5.29E+07	1.55E+07	9.62E+09	6.22E+07	0.00E+00	8.96E+06
CS-134	3.65E+10	6.81E+10	6.88E+09	0.00E+00	1.75E+10	7.19E+09	1.85E+08
CS-136	1.98E+09	5.83E+09	2.18E+09	0.00E+00	2.32E+09	4.75E+08	8.85E+07
CS-137	5.15E+10	6.03E+10	4.27E+09	0.00E+00	1.62E+10	6.55E+09	1.89E+08
BA-140	2.42E+08	2.42E+05	1.25E+07	0.00E+00	5.75E+04	1.49E+05	5.94E+07
CE-141	4.34E+04	2.65E+04	3.12E+03	0.00E+00	8.17E+03	0.00E+00	1.37E+07
CE-144	2.33E+06	9.53E+05	1.30E+05	0.00E+00	3.85E+05	0.00E+00	1.34E+08
PR-143	1.49E+03	5.56E+02	7.37E+01	0.00E+00	2.07E+02	0.00E+00	7.84E+05
ND-147	8.83E+02	9.07E+02	5.55E+01	0.00E+00	3.50E+02	0.00E+00	5.75E+05

TABLE 2.4
PATHWAY DOSE FACTORS

AGE GROUP: ADULT PATHWAY: GRASS-COW-MEAT

NUCLIDE	ORGAN DOSE FACTORS						
	BONE	LIVER	T. BODY	THYROID	KIDNEY	LUNG	GI-LLI
H-3	0.00E+00	3.24E+02	3.24E+02	3.24E+02	3.24E+02	3.24E+02	3.24E+02
P-32	4.63E+09	2.88E+08	1.79E+08	0.00E+00	0.00E+00	0.00E+00	5.21E+08
CR-51	0.00E+00	0.00E+00	7.04E+03	4.21E+03	1.55E+03	9.35E+03	1.77E+06
MN-54	0.00E+00	9.18E+06	1.75E+06	0.00E+00	2.73E+06	0.00E+00	2.81E+07
FE-55	2.93E+08	2.03E+08	4.73E+07	0.00E+00	0.00E+00	1.13E+08	1.16E+08
FE-59	2.66E+08	6.25E+08	2.39E+08	0.00E+00	0.00E+00	1.75E+08	2.08E+09
CO-58	0.00E+00	1.82E+07	4.09E+07	0.00E+00	0.00E+00	0.00E+00	3.70E+08
CO-60	0.00E+00	7.52E+07	1.66E+08	0.00E+00	0.00E+00	0.00E+00	1.41E+09
NI-63	1.89E+10	1.31E+09	6.33E+08	0.00E+00	0.00E+00	0.00E+00	2.73E+08
ZN-65	3.56E+08	1.13E+09	5.12E+08	0.00E+00	7.57E+08	0.00E+00	7.13E+08
RB-86	0.00E+00	4.87E+08	2.27E+08	0.00E+00	0.00E+00	0.00E+00	9.59E+07
SR-89	3.02E+08	0.00E+00	8.66E+06	0.00E+00	0.00E+00	0.00E+00	4.84E+07
SR-90	1.24E+10	0.00E+00	3.05E+09	0.00E+00	0.00E+00	0.00E+00	3.60E+08
Y-91	1.13E+06	0.00E+00	3.03E+04	0.00E+00	0.00E+00	0.00E+00	6.24E+08
ZR-95	1.87E+06	6.01E+05	4.07E+05	0.00E+00	9.43E+05	0.00E+00	1.90E+09
NB-95	2.30E+06	1.28E+06	6.87E+05	0.00E+00	1.26E+06	0.00E+00	7.76E+09
RU-103	1.05E+08	0.00E+00	4.53E+07	0.00E+00	4.02E+08	0.00E+00	1.23E+10
RU-106	2.80E+09	0.00E+00	3.54E+08	0.00E+00	5.41E+09	0.00E+00	1.81E+11
AG-110M	6.68E+06	6.18E+06	3.67E+06	0.00E+00	1.22E+07	0.00E+00	2.52E+09
TE-125M	3.59E+08	1.30E+08	4.81E+07	1.08E+08	1.46E+09	0.00E+00	1.43E+09
TE-127M	1.12E+09	3.99E+08	1.36E+08	2.85E+08	4.53E+09	0.00E+00	3.74E+09
TE-129M	1.13E+09	4.23E+08	1.79E+08	3.89E+08	4.73E+09	0.00E+00	5.71E+09
I-131	1.08E+07	1.54E+07	8.82E+06	5.04E+09	2.64E+07	0.00E+00	4.06E+06
I-133	3.68E-01	6.41E-01	1.95E-01	9.42E+01	1.12E+00	0.00E+00	5.76E-01
CS-134	6.58E+08	1.57E+09	1.28E+09	0.00E+00	5.07E+08	1.68E+08	2.74E+07
CS-136	1.21E+07	4.78E+07	3.44E+07	0.00E+00	2.66E+07	3.65E+06	5.43E+06
CS-137	8.72E+08	1.19E+09	7.82E+08	0.00E+00	4.05E+08	1.35E+08	2.31E+07
BA-140	2.90E+07	3.64E+04	1.90E+06	0.00E+00	1.24E+04	2.08E+04	5.96E+07
CE-141	1.41E+04	9.51E+03	1.08E+03	0.00E+00	4.42E+03	0.00E+00	3.64E+07
CE-144	1.46E+06	6.10E+05	7.83E+04	0.00E+00	3.62E+05	0.00E+00	4.93E+08
PR-143	2.09E+04	8.40E+03	1.04E+03	0.00E+00	4.85E+03	0.00E+00	9.17E+07
ND-147	7.08E+03	8.18E+03	4.90E+02	0.00E+00	4.78E+03	0.00E+00	3.93E+07

TABLE 2.4
PATHWAY DOSE FACTORS

AGE GROUP: TEEN PATHWAY: GRASS-COW-MEAT

NUCLIDE	ORGAN DOSE FACTORS						
	BONE	LIVER	T. BODY	THYROID	KIDNEY	LUNG	GI-LLI
H-3	0.00E+00	1.93E+02	1.93E+02	1.93E+02	1.93E+02	1.93E+02	1.93E+02
P-32	3.91E+09	2.42E+08	1.52E+08	0.00E+00	0.00E+00	0.00E+00	3.29E+08
CR-51	0.00E+00	0.00E+00	5.63E+03	3.13E+03	1.23E+03	8.03E+03	9.46E+05
MN-54	0.00E+00	7.00E+06	1.39E+06	0.00E+00	2.09E+06	0.00E+00	1.44E+07
FE-55	2.38E+08	1.69E+08	3.94E+07	0.00E+00	0.00E+00	1.07E+08	7.31E+07
FE-59	2.12E+08	4.95E+08	1.91E+08	0.00E+00	0.00E+00	1.56E+08	1.17E+09
CO-58	0.00E+00	1.40E+07	3.24E+07	0.00E+00	0.00E+00	0.00E+00	1.94E+08
CO-60	0.00E+00	5.83E+07	1.31E+08	0.00E+00	0.00E+00	0.00E+00	7.60E+08
NI-63	1.52E+10	1.07E+09	5.15E+08	0.00E+00	0.00E+00	0.00E+00	1.71E+08
ZN-65	2.50E+08	8.68E+08	4.05E+08	0.00E+00	5.56E+08	0.00E+00	3.68E+08
RB-86	0.00E+00	4.06E+08	1.91E+08	0.00E+00	0.00E+00	0.00E+00	6.00E+07
SR-89	2.55E+08	0.00E+00	7.29E+06	0.00E+00	0.00E+00	0.00E+00	3.03E+07
SR-90	8.04E+09	0.00E+00	1.99E+09	0.00E+00	0.00E+00	0.00E+00	2.26E+08
Y-91	9.54E+05	0.00E+00	2.56E+04	0.00E+00	0.00E+00	0.00E+00	3.91E+08
ZR-95	1.50E+06	4.73E+05	3.25E+05	0.00E+00	6.95E+05	0.00E+00	1.09E+09
NB-95	1.79E+06	9.95E+05	5.48E+05	0.00E+00	9.64E+05	0.00E+00	4.25E+09
RU-103	8.56E+07	0.00E+00	3.66E+07	0.00E+00	3.02E+08	0.00E+00	7.15E+09
RU-106	2.36E+09	0.00E+00	2.97E+08	0.00E+00	4.54E+09	0.00E+00	1.13E+11
AG-110M	5.06E+06	4.78E+06	2.91E+06	0.00E+00	9.13E+06	0.00E+00	1.34E+09
TE-125M	3.03E+08	1.09E+08	4.05E+07	8.46E+07	0.00E+00	0.00E+00	8.94E+08
TE-127M	9.41E+08	3.34E+08	1.12E+08	2.24E+08	3.81E+09	0.00E+00	2.35E+09
TE-129M	9.49E+08	3.52E+08	1.50E+08	3.06E+08	3.97E+09	0.00E+00	3.56E+09
I-131	8.93E+06	1.25E+07	6.72E+06	3.65E+09	2.15E+07	0.00E+00	2.47E+06
I-133	3.08E-01	5.22E-01	1.59E-01	7.29E+01	9.16E-01	0.00E+00	3.95E-01
CS-134	5.23E+08	1.23E+09	5.71E+08	0.00E+00	3.91E+08	1.49E+08	1.53E+07
CS-136	9.43E+06	3.71E+07	2.49E+07	0.00E+00	2.02E+07	3.18E+06	2.99E+06
CS-137	7.24E+08	9.63E+08	3.35E+08	0.00E+00	3.28E+08	1.27E+08	1.37E+07
BA-140	2.39E+07	2.93E+04	1.54E+06	0.00E+00	9.94E+03	1.97E+04	3.69E+07
CE-141	1.18E+04	7.87E+03	9.05E+02	0.00E+00	3.71E+03	0.00E+00	2.25E+07
CE-144	1.23E+06	5.08E+05	6.60E+04	0.00E+00	3.03E+05	0.00E+00	3.09E+08
PR-143	1.76E+04	7.03E+03	8.76E+02	0.00E+00	4.08E+03	0.00E+00	5.79E+07
ND-147	6.23E+03	6.78E+03	4.06E+02	0.00E+00	3.98E+03	0.00E+00	2.44E+07

TABLE 2.4
PATHWAY DOSE FACTORS

AGE GROUP: CHILD		PATHWAY: GRASS-COW-MEAT					
NUCLIDE	ORGAN DOSE FACTORS						
	BONE	LIVER	T. BODY	THYROID	KIDNEY	LUNG	GI-LLI
H-3	0.00E+00	2.34E+02	2.34E+02	2.34E+02	2.34E+02	2.34E+02	2.34E+02
P-32	7.38E+09	3.45E+08	2.85E+08	0.00E+00	0.00E+00	0.00E+00	2.04E+08
CR-51	0.00E+00	0.00E+00	8.78E+03	4.88E+03	1.33E+03	8.90E+03	4.66E+05
MN-54	0.00E+00	8.01E+06	2.13E+06	0.00E+00	2.25E+06	0.00E+00	6.73E+06
FE-55	4.57E+08	2.43E+08	7.52E+07	0.00E+00	0.00E+00	1.37E+08	4.49E+07
FE-59	3.77E+08	6.10E+08	3.04E+08	0.00E+00	0.00E+00	1.77E+08	6.35E+08
CO-58	0.00E+00	1.64E+07	5.03E+07	0.00E+00	0.00E+00	0.00E+00	9.58E+07
CO-60	0.00E+00	6.93E+07	2.04E+08	0.00E+00	0.00E+00	0.00E+00	3.84E+08
NI-63	2.91E+10	1.56E+09	9.91E+08	0.00E+00	0.00E+00	0.00E+00	1.05E+08
ZN-65	3.76E+08	1.00E+09	6.22E+08	0.00E+00	6.31E+08	0.00E+00	1.76E+08
RB-86	0.00E+00	5.76E+08	3.54E+08	0.00E+00	0.00E+00	0.00E+00	3.71E+07
SR-89	4.82E+08	0.00E+00	1.38E+07	0.00E+00	0.00E+00	0.00E+00	1.87E+07
SR-90	1.04E+10	0.00E+00	2.64E+09	0.00E+00	0.00E+00	0.00E+00	1.40E+08
Y-91	1.80E+06	0.00E+00	4.82E+04	0.00E+00	0.00E+00	0.00E+00	2.40E+08
ZR-95	2.66E+06	5.86E+05	5.21E+05	0.00E+00	8.38E+05	0.00E+00	6.11E+08
NB-95	3.10E+06	1.21E+06	8.63E+05	0.00E+00	1.13E+06	0.00E+00	2.23E+09
RU-103	1.55E+08	0.00E+00	5.96E+07	0.00E+00	3.90E+08	0.00E+00	4.01E+09
RU-106	4.44E+09	0.00E+00	5.54E+08	0.00E+00	6.00E+09	0.00E+00	6.91E+10
AG-110M	8.39E+06	5.67E+06	4.53E+06	0.00E+00	1.06E+07	0.00E+00	6.74E+08
TE-125M	5.69E+08	1.54E+08	7.59E+07	1.60E+08	0.00E+00	0.00E+00	5.49E+08
TE-127M	1.78E+09	4.78E+08	2.11E+08	4.25E+08	5.06E+09	0.00E+00	1.44E+09
TE-129M	1.79E+09	5.00E+08	2.78E+08	5.77E+08	5.26E+09	0.00E+00	2.18E+09
I-131	1.66E+07	1.67E+07	9.48E+06	5.52E+09	2.74E+07	0.00E+00	1.48E+06
I-133	5.72E-01	7.08E-01	2.68E-01	1.31E+02	1.18E+00	0.00E+00	2.85E-01
CS-134	9.23E+08	1.51E+09	3.19E+08	0.00E+00	4.69E+08	1.68E+08	8.16E+06
CS-136	1.63E+07	4.48E+07	2.90E+07	0.00E+00	2.39E+07	3.56E+06	1.57E+06
CS-137	1.33E+09	1.28E+09	1.89E+08	0.00E+00	4.16E+08	1.50E+08	8.00E+06
BA-140	4.42E+07	3.87E+04	2.58E+06	0.00E+00	1.26E+04	2.31E+04	2.24E+07
CE-141	2.22E+04	1.11E+04	1.65E+03	0.00E+00	4.86E+03	0.00E+00	1.38E+07
CE-144	2.32E+06	7.26E+05	1.24E+05	0.00E+00	4.02E+05	0.00E+00	1.89E+08
PR-143	3.33E+04	1.00E+04	1.65E+03	0.00E+00	5.42E+03	0.00E+00	3.60E+07
ND-147	1.17E+04	9.48E+03	7.34E+02	0.00E+00	5.20E+03	0.00E+00	1.50E+07

TABLE 2.4
PATHWAY DOSE FACTORS

AGE GROUP: INFANT PATHWAY: GRASS-COW-MEAT

NUCLIDE	ORGAN DOSE FACTORS						
	BONE	LIVER	T. BODY	THYROID	KIDNEY	LUNG	GI-LLI
H-3	0.00E+00	0.00E+00	0.00E+00	0.00E+00	0.00E+00	0.00E+00	0.00E+00
P-32	0.00E+00	0.00E+00	0.00E+00	0.00E+00	0.00E+00	0.00E+00	0.00E+00
CR-51	0.00E+00	0.00E+00	0.00E+00	0.00E+00	0.00E+00	0.00E+00	0.00E+00
MN-54	0.00E+00	0.00E+00	0.00E+00	0.00E+00	0.00E+00	0.00E+00	0.00E+00
FE-55	0.00E+00	0.00E+00	0.00E+00	0.00E+00	0.00E+00	0.00E+00	0.00E+00
FE-59	0.00E+00	0.00E+00	0.00E+00	0.00E+00	0.00E+00	0.00E+00	0.00E+00
CO-58	0.00E+00	0.00E+00	0.00E+00	0.00E+00	0.00E+00	0.00E+00	0.00E+00
CO-60	0.00E+00	0.00E+00	0.00E+00	0.00E+00	0.00E+00	0.00E+00	0.00E+00
NI-63	0.00E+00	0.00E+00	0.00E+00	0.00E+00	0.00E+00	0.00E+00	0.00E+00
ZN-65	0.00E+00	0.00E+00	0.00E+00	0.00E+00	0.00E+00	0.00E+00	0.00E+00
RB-86	0.00E+00	0.00E+00	0.00E+00	0.00E+00	0.00E+00	0.00E+00	0.00E+00
SR-89	0.00E+00	0.00E+00	0.00E+00	0.00E+00	0.00E+00	0.00E+00	0.00E+00
SR-90	0.00E+00	0.00E+00	0.00E+00	0.00E+00	0.00E+00	0.00E+00	0.00E+00
Y-91	0.00E+00	0.00E+00	0.00E+00	0.00E+00	0.00E+00	0.00E+00	0.00E+00
ZR-95	0.00E+00	0.00E+00	0.00E+00	0.00E+00	0.00E+00	0.00E+00	0.00E+00
NB-95	0.00E+00	0.00E+00	0.00E+00	0.00E+00	0.00E+00	0.00E+00	0.00E+00
RU-103	0.00E+00	0.00E+00	0.00E+00	0.00E+00	0.00E+00	0.00E+00	0.00E+00
RU-106	0.00E+00	0.00E+00	0.00E+00	0.00E+00	0.00E+00	0.00E+00	0.00E+00
AG-110M	0.00E+00	0.00E+00	0.00E+00	0.00E+00	0.00E+00	0.00E+00	0.00E+00
TE-125M	0.00E+00	0.00E+00	0.00E+00	0.00E+00	0.00E+00	0.00E+00	0.00E+00
TE-127M	0.00E+00	0.00E+00	0.00E+00	0.00E+00	0.00E+00	0.00E+00	0.00E+00
TE-129M	0.00E+00	0.00E+00	0.00E+00	0.00E+00	0.00E+00	0.00E+00	0.00E+00
I-131	0.00E+00	0.00E+00	0.00E+00	0.00E+00	0.00E+00	0.00E+00	0.00E+00
I-133	0.00E+00	0.00E+00	0.00E+00	0.00E+00	0.00E+00	0.00E+00	0.00E+00
CS-134	0.00E+00	0.00E+00	0.00E+00	0.00E+00	0.00E+00	0.00E+00	0.00E+00
CS-136	0.00E+00	0.00E+00	0.00E+00	0.00E+00	0.00E+00	0.00E+00	0.00E+00
CS-137	0.00E+00	0.00E+00	0.00E+00	0.00E+00	0.00E+00	0.00E+00	0.00E+00
BA-140	0.00E+00	0.00E+00	0.00E+00	0.00E+00	0.00E+00	0.00E+00	0.00E+00
CE-141	0.00E+00	0.00E+00	0.00E+00	0.00E+00	0.00E+00	0.00E+00	0.00E+00
CE-144	0.00E+00	0.00E+00	0.00E+00	0.00E+00	0.00E+00	0.00E+00	0.00E+00
PR-143	0.00E+00	0.00E+00	0.00E+00	0.00E+00	0.00E+00	0.00E+00	0.00E+00
ND-147	0.00E+00	0.00E+00	0.00E+00	0.00E+00	0.00E+00	0.00E+00	0.00E+00

TABLE 2.4
PATHWAY DOSE FACTORS

AGE GROUP: ADULT		PATHWAY: GRASS-GOAT-MILK					
NUCLIDE	ORGAN DOSE FACTORS						
	BONE	LIVER	T. BODY	THYROID	KIDNEY	LUNG	GI-LLI
H-3	0.00E+00	1.56E+03	1.56E+03	1.56E+03	1.56E+03	1.56E+03	1.56E+03
P-32	2.05E+10	1.27E+09	7.92E+08	0.00E+00	0.00E+00	0.00E+00	2.30E+09
CR-51	0.00E+00	0.00E+00	3.43E+03	2.05E+03	7.56E+02	4.55E+03	8.63E+05
MN-54	0.00E+00	1.01E+06	1.93E+05	0.00E+00	3.01E+05	0.00E+00	3.10E+06
FE-55	3.27E+05	2.26E+05	5.26E+04	0.00E+00	0.00E+00	1.26E+05	1.30E+05
FE-59	3.87E+05	9.09E+05	3.48E+05	0.00E+00	0.00E+00	2.54E+05	3.03E+06
CO-58	0.00E+00	5.66E+05	1.27E+06	0.00E+00	0.00E+00	0.00E+00	1.15E+07
CO-60	0.00E+00	1.97E+06	4.35E+06	0.00E+00	0.00E+00	0.00E+00	3.70E+07
NI-63	8.08E+08	5.60E+07	2.71E+07	0.00E+00	0.00E+00	0.00E+00	1.17E+07
ZN-65	1.65E+08	5.24E+08	2.37E+08	0.00E+00	3.51E+08	0.00E+00	3.30E+08
RB-86	0.00E+00	3.12E+08	1.45E+08	0.00E+00	0.00E+00	0.00E+00	6.14E+07
SR-89	3.05E+09	0.00E+00	8.76E+07	0.00E+00	0.00E+00	0.00E+00	4.89E+08
SR-90	9.84E+10	0.00E+00	2.41E+10	0.00E+00	0.00E+00	0.00E+00	2.84E+09
Y-91	1.03E+03	0.00E+00	2.76E+01	0.00E+00	0.00E+00	0.00E+00	5.68E+05
ZR-95	1.13E+02	3.63E+01	2.46E+01	0.00E+00	5.70E+01	0.00E+00	1.15E+05
NB-95	9.92E+03	5.52E+03	2.97E+03	0.00E+00	5.45E+03	0.00E+00	3.35E+07
RU-103	1.22E+02	0.00E+00	5.27E+01	0.00E+00	4.67E+02	0.00E+00	1.43E+04
RU-106	2.45E+03	0.00E+00	3.10E+02	0.00E+00	4.73E+03	0.00E+00	1.59E+05
AG-110M	6.99E+06	6.47E+06	3.84E+06	0.00E+00	1.27E+07	0.00E+00	2.64E+09
TE-125M	1.96E+06	7.09E+05	2.62E+05	5.89E+05	7.96E+06	0.00E+00	7.81E+06
TE-127M	5.50E+06	1.97E+06	6.70E+05	1.41E+06	2.23E+07	0.00E+00	1.84E+07
TE-129M	7.23E+06	2.70E+06	1.14E+06	2.48E+06	3.02E+07	0.00E+00	3.64E+07
I-131	3.56E+08	5.09E+08	2.92E+08	1.67E+11	8.73E+08	0.00E+00	1.34E+08
I-133	4.65E+06	8.10E+06	2.47E+06	1.19E+09	1.41E+07	0.00E+00	7.28E+06
CS-134	1.70E+10	4.04E+10	3.30E+10	0.00E+00	1.31E+10	4.34E+09	7.07E+08
CS-136	7.92E+08	3.13E+09	2.25E+09	0.00E+00	1.74E+09	2.38E+08	3.55E+08
CS-137	2.22E+10	3.03E+10	1.99E+10	0.00E+00	1.03E+10	3.42E+09	5.87E+08
BA-140	3.24E+06	4.07E+03	2.12E+05	0.00E+00	1.38E+03	2.33E+03	6.67E+06
CE-141	5.82E+02	3.94E+02	4.47E+01	0.00E+00	1.83E+02	0.00E+00	1.51E+06
CE-144	4.30E+04	1.80E+04	2.31E+03	0.00E+00	1.07E+04	0.00E+00	1.45E+07
PR-143	1.90E+01	7.60E+00	9.40E-01	0.00E+00	4.39E+00	0.00E+00	8.30E+04
ND-147	1.13E+01	1.31E+01	7.82E-01	0.00E+00	7.65E+00	0.00E+00	6.28E+04

TABLE 2.4
PATHWAY DOSE FACTORS

NUCLIDE	AGE GROUP: TEEN PATHWAY: GRASS-GOAT-MILK						
	ORGAN DOSE FACTORS						
	BONE	LIVER	T. BODY	THYROID	KIDNEY	LUNG	GI-LLI
H-3	0.00E+00	2.04E+03	2.04E+03	2.04E+03	2.04E+03	2.04E+03	2.04E+03
P-32	3.78E+10	2.34E+09	1.46E+09	0.00E+00	0.00E+00	0.00E+00	3.18E+09
CR-51	0.00E+00	0.00E+00	5.99E+03	3.33E+03	1.31E+03	8.55E+03	1.01E+06
MN-54	0.00E+00	1.68E+06	3.34E+05	0.00E+00	5.02E+05	0.00E+00	3.45E+06
FE-55	5.79E+05	4.11E+05	9.58E+04	0.00E+00	0.00E+00	2.61E+05	1.78E+05
FE-59	6.74E+05	1.57E+06	6.08E+05	0.00E+00	0.00E+00	4.96E+05	3.72E+06
CO-58	0.00E+00	9.53E+05	2.20E+06	0.00E+00	0.00E+00	0.00E+00	1.31E+07
CO-60	0.00E+00	3.34E+06	7.52E+06	0.00E+00	0.00E+00	0.00E+00	4.35E+07
NI-63	1.42E+09	1.00E+08	4.81E+07	0.00E+00	0.00E+00	0.00E+00	1.60E+07
ZN-65	2.53E+08	8.78E+08	4.10E+08	0.00E+00	5.62E+08	0.00E+00	3.72E+08
RB-86	0.00E+00	5.67E+08	2.67E+08	0.00E+00	0.00E+00	0.00E+00	8.40E+07
SR-89	5.62E+09	0.00E+00	1.61E+08	0.00E+00	0.00E+00	0.00E+00	6.69E+08
SR-90	1.39E+11	0.00E+00	3.43E+10	0.00E+00	0.00E+00	0.00E+00	3.90E+09
Y-91	1.90E+03	0.00E+00	5.09E+01	0.00E+00	0.00E+00	0.00E+00	7.78E+05
ZR-95	1.98E+02	6.25E+01	4.30E+01	0.00E+00	9.18E+01	0.00E+00	1.44E+05
NB-95	1.69E+04	9.38E+03	5.16E+03	0.00E+00	9.09E+03	0.00E+00	4.01E+07
RU-103	2.17E+02	0.00E+00	9.29E+01	0.00E+00	7.66E+02	0.00E+00	1.82E+04
RU-106	4.50E+03	0.00E+00	5.68E+02	0.00E+00	8.69E+03	0.00E+00	2.16E+05
AG-110M	1.16E+07	1.09E+07	6.65E+06	0.00E+00	2.09E+07	0.00E+00	3.07E+09
TE-125M	3.61E+06	1.30E+06	4.82E+05	1.01E+06	0.00E+00	0.00E+00	1.06E+07
TE-127M	1.01E+07	3.59E+06	1.20E+06	2.41E+06	4.11E+07	0.00E+00	2.52E+07
TE-129M	1.32E+07	4.90E+06	2.09E+06	4.26E+06	5.53E+07	0.00E+00	4.96E+07
I-131	6.45E+08	9.03E+08	4.85E+08	2.64E+11	1.56E+09	0.00E+00	1.79E+08
I-133	8.49E+06	1.44E+07	4.40E+06	2.01E+09	2.53E+07	0.00E+00	1.09E+07
CS-134	2.95E+10	6.93E+10	3.22E+10	0.00E+00	2.20E+10	8.41E+09	8.62E+08
CS-136	1.35E+09	5.30E+09	3.56E+09	0.00E+00	2.89E+09	4.55E+08	4.27E+08
CS-137	4.02E+10	5.34E+10	1.86E+10	0.00E+00	1.82E+10	7.07E+09	7.60E+08
BA-140	5.84E+06	7.16E+03	3.76E+05	0.00E+00	2.43E+03	4.81E+03	9.01E+06
CE-141	1.07E+03	7.12E+02	8.18E+01	0.00E+00	3.35E+02	0.00E+00	2.04E+06
CE-144	7.90E+04	3.27E+04	4.25E+03	0.00E+00	1.95E+04	0.00E+00	1.99E+07
PR-143	3.48E+01	1.39E+01	1.73E+00	0.00E+00	8.08E+00	0.00E+00	1.15E+05
ND-147	2.18E+01	2.37E+01	1.42E+00	0.00E+00	1.39E+01	0.00E+00	8.54E+04

TABLE 2.4
PATHWAY DOSE FACTORS

AGE GROUP: CHILD PATHWAY: GRASS-GOAT-MILK

NUCLIDE	ORGAN DOSE FACTORS						
	BONE	LIVER	T. BODY	THYROID	KIDNEY	LUNG	GI-LLI
H-3	0.00E+00	3.20E+03	3.20E+03	3.20E+03	3.20E+03	3.20E+03	3.20E+03
P-32	9.32E+10	4.36E+09	3.59E+09	0.00E+00	0.00E+00	0.00E+00	2.58E+09
CR-51	0.00E+00	0.00E+00	1.22E+04	6.78E+03	1.85E+03	1.24E+04	6.48E+05
MN-54	0.00E+00	2.52E+00	6.71E+05	0.00E+00	7.06E+05	0.00E+00	2.11E+06
FE-55	1.45E+06	7.71E+00	2.39E+05	0.00E+00	0.00E+00	4.36E+05	1.43E+05
FE-59	1.56E+06	2.53E+06	1.26E+06	0.00E+00	0.00E+00	7.34E+05	2.64E+06
CO-58	0.00E+00	1.46E+06	4.46E+06	0.00E+00	0.00E+00	0.00E+00	8.49E+06
CO-60	0.00E+00	5.18E+06	1.53E+07	0.00E+00	0.00E+00	0.00E+00	2.87E+07
NI-63	3.56E+09	1.91E+08	1.21E+08	0.00E+00	0.00E+00	0.00E+00	1.28E+07
ZN-65	4.96E+08	1.32E+09	8.22E+08	0.00E+00	8.33E+08	0.00E+00	2.32E+08
RB-86	0.00E+00	1.05E+09	6.47E+08	0.00E+00	0.00E+00	0.00E+00	6.77E+07
SR-89	1.39E+10	0.00E+00	3.97E+08	0.00E+00	0.00E+00	0.00E+00	5.39E+08
SR-90	2.35E+11	0.00E+00	5.95E+10	0.00E+00	0.00E+00	0.00E+00	3.16E+09
Y-91	4.69E+03	0.00E+00	1.25E+02	0.00E+00	0.00E+00	0.00E+00	6.24E+05
ZR-95	4.60E+02	1.01E+02	9.00E+01	0.00E+00	1.45E+02	0.00E+00	1.05E+05
NB-95	3.82E+04	1.49E+04	1.06E+04	0.00E+00	1.40E+04	0.00E+00	2.75E+07
RU-103	5.14E+02	0.00E+00	1.98E+02	0.00E+00	1.29E+03	0.00E+00	1.33E+04
RU-106	1.11E+04	0.00E+00	1.38E+03	0.00E+00	1.50E+04	0.00E+00	1.73E+05
AG-110M	2.51E+07	1.69E+07	1.35E+07	0.00E+00	3.15E+07	0.00E+00	2.01E+09
TE-125M	8.86E+06	2.40E+06	1.18E+06	2.49E+06	0.00E+00	0.00E+00	8.55E+06
TE-127M	2.50E+07	6.72E+06	2.96E+06	5.97E+06	7.12E+07	0.00E+00	2.02E+07
TE-129M	3.26E+07	9.10E+06	5.06E+06	1.05E+07	9.56E+07	0.00E+00	3.97E+07
I-131	1.57E+09	1.57E+09	8.95E+08	5.21E+11	2.58E+09	0.00E+00	1.40E+08
I-133	2.06E+07	2.55E+07	9.66E+06	4.74E+09	4.25E+07	0.00E+00	1.03E+07
CS-134	6.80E+10	1.12E+11	2.35E+10	0.00E+00	3.46E+10	1.24E+10	6.01E+08
CS-136	3.04E+09	8.36E+09	5.41E+09	0.00E+00	4.45E+09	6.64E+08	2.94E+08
CS-137	9.68E+10	9.26E+10	1.37E+10	0.00E+00	3.02E+10	1.09E+10	5.80E+08
BA-140	1.41E+07	1.24E+04	8.23E+05	0.00E+00	4.02E+03	7.37E+03	7.15E+06
CE-141	2.63E+03	1.31E+03	1.95E+02	0.00E+00	5.74E+02	0.00E+00	1.63E+06
CE-144	1.95E+05	6.11E+04	1.04E+04	0.00E+00	3.38E+04	0.00E+00	1.59E+07
PR-143	8.61E+01	2.59E+01	4.27E+00	0.00E+00	1.40E+01	0.00E+00	9.29E+04
ND-147	5.34E+01	4.33E+01	3.35E+00	0.00E+00	2.37E+01	0.00E+00	6.85E+04

TABLE 2.4
PATHWAY DOSE FACTORS

AGE GROUP: INFANT PATHWAY: GRASS-GOAT-MILK

NUCLIDE	ORGAN DOSE FACTORS						
	BONE	LIVER	T. BODY	THYROID	KIDNEY	LUNG	GI-LLI
H-3	0.00E+00	4.86E+03	4.86E+03	4.86E+03	4.86E+03	4.86E+03	4.86E+03
P-32	1.92E+11	1.13E+10	7.44E+09	0.00E+00	0.00E+00	0.00E+00	2.60E+09
CR-51	0.00E+00	0.00E+00	1.94E+04	1.26E+04	2.76E+03	2.46E+04	5.64E+05
MN-54	0.00E+00	4.68E+06	1.06E+06	0.00E+00	1.04E+06	0.00E+00	1.72E+06
FE-55	1.76E+06	1.14E+06	3.03E+05	0.00E+00	0.00E+00	5.55E+05	1.44E+05
FE-59	2.92E+06	5.10E+06	2.01E+06	0.00E+00	0.00E+00	1.51E+06	2.44E+06
CO-58	0.00E+00	2.91E+06	7.26E+06	0.00E+00	0.00E+00	0.00E+00	7.25E+06
CO-60	0.00E+00	1.06E+07	2.50E+07	0.00E+00	0.00E+00	0.00E+00	2.52E+07
NI-63	4.19E+09	2.59E+08	1.46E+08	0.00E+00	0.00E+00	0.00E+00	1.29E+07
ZN-65	6.67E+08	2.29E+09	1.05E+09	0.00E+00	1.11E+09	0.00E+00	1.93E+09
RB-86	0.00E+00	2.67E+09	1.32E+09	0.00E+00	0.00E+00	0.00E+00	6.83E+07
SR-89	2.65E+10	0.00E+00	7.59E+08	0.00E+00	0.00E+00	0.00E+00	5.44E+08
SR-90	2.55E+11	0.00E+00	6.50E+10	0.00E+00	0.00E+00	0.00E+00	3.19E+09
Y-91	8.80E+03	0.00E+00	2.34E+02	0.00E+00	0.00E+00	0.00E+00	6.31E+05
ZR-95	8.17E+02	1.99E+02	1.41E+02	0.00E+00	2.15E+02	0.00E+00	9.91E+04
NB-95	7.13E+04	2.93E+04	1.70E+04	0.00E+00	2.10E+04	0.00E+00	2.48E+07
RU-103	1.04E+03	0.00E+00	3.48E+02	0.00E+00	2.17E+03	0.00E+00	1.27E+04
RU-106	2.28E+04	0.00E+00	2.85E+03	0.00E+00	2.70E+04	0.00E+00	1.73E+05
AG-110M	4.63E+07	3.38E+07	2.24E+07	0.00E+00	4.84E+07	0.00E+00	1.75E+09
TE-125M	1.81E+07	6.05E+06	2.45E+06	6.09E+06	0.00E+00	0.00E+00	8.62E+06
TE-127M	5.06E+07	1.68E+07	6.12E+06	1.46E+07	1.24E+08	0.00E+00	2.04E+07
TE-129M	6.69E+07	2.29E+07	1.03E+07	2.57E+07	1.67E+08	0.00E+00	3.99E+07
I-131	3.27E+09	3.85E+09	1.69E+09	1.27E+12	4.50E+09	0.00E+00	1.37E+08
I-133	4.36E+07	6.35E+07	1.86E+07	1.15E+10	7.46E+07	0.00E+00	1.07E+07
CS-134	1.09E+11	2.04E+11	2.06E+10	0.00E+00	5.26E+10	2.15E+10	5.55E+08
CS-136	5.94E+09	1.75E+10	6.52E+09	0.00E+00	6.96E+09	1.42E+09	2.65E+08
CS-137	1.54E+11	1.81E+11	1.28E+10	0.00E+00	4.85E+10	1.96E+10	5.65E+08
BA-140	2.90E+07	2.90E+04	1.50E+06	0.00E+00	6.89E+03	1.78E+04	7.13E+06
CE-141	5.21E+03	3.18E+03	3.74E+02	0.00E+00	9.79E+02	0.00E+00	1.64E+06
CE-144	2.79E+05	1.14E+05	1.56E+04	0.00E+00	4.62E+04	0.00E+00	1.60E+07
PR-143	1.78E+02	6.66E+01	8.83E+00	0.00E+00	2.48E+01	0.00E+00	9.40E+04
ND-147	1.06E+02	1.09E+02	6.66E+00	0.00E+00	4.19E+01	0.00E+00	6.89E+04

TABLE 2.4
PATHWAY DOSE FACTORS

NUCLIDE	ORGAN DOSE FACTORS						
	BONE	LIVER	T. BODY	THYROID	KIDNEY	LUNG	GI-LLI
H-3	0.00E+00	2.26E+03	2.26E+03	2.26E+03	2.26E+03	2.26E+03	2.26E+03
P-32	1.40E+09	8.69E+07	5.40E+07	0.00E+00	0.00E+00	0.00E+00	1.57E+08
CR-51	0.00E+00	0.00E+00	4.64E+04	2.77E+04	1.02E+04	6.15E+04	1.17E+07
MN-54	0.00E+00	3.13E+08	5.97E+07	0.00E+00	9.31E+07	0.00E+00	9.58E+08
FE-55	2.10E+08	1.45E+08	3.38E+07	0.00E+00	0.00E+00	8.08E+07	8.31E+07
FE-59	1.26E+08	2.97E+08	1.14E+08	0.00E+00	0.00E+00	8.29E+07	9.89E+08
CO-58	0.00E+00	3.07E+07	6.89E+07	0.00E+00	0.00E+00	0.00E+00	6.23E+08
CO-60	0.00E+00	1.67E+08	3.69E+08	0.00E+00	0.00E+00	0.00E+00	3.14E+09
NI-63	1.04E+10	7.21E+08	3.49E+08	0.00E+00	0.00E+00	0.00E+00	1.50E+08
ZN-65	3.17E+08	1.01E+09	4.56E+08	0.00E+00	6.75E+08	0.00E+00	6.36E+08
RB-86	0.00E+00	2.19E+08	1.02E+08	0.00E+00	0.00E+00	0.00E+00	4.32E+07
SR-89	9.98E+09	0.00E+00	2.86E+08	0.00E+00	0.00E+00	0.00E+00	1.60E+09
SR-90	6.05E+11	0.00E+00	1.48E+11	0.00E+00	0.00E+00	0.00E+00	1.75E+10
Y-91	5.12E+06	0.00E+00	1.37E+05	0.00E+00	0.00E+00	0.00E+00	2.82E+09
ZR-95	1.17E+06	3.77E+05	2.55E+05	0.00E+00	5.91E+05	0.00E+00	1.19E+09
NB-95	1.42E+05	7.92E+04	4.26E+04	0.00E+00	7.83E+04	0.00E+00	4.81E+08
RU-103	4.77E+06	0.00E+00	2.06E+06	0.00E+00	1.82E+07	0.00E+00	5.57E+08
RU-106	1.93E+08	0.00E+00	2.44E+07	0.00E+00	3.72E+08	0.00E+00	1.25E+10
AG-110M	1.05E+07	9.75E+06	5.79E+06	0.00E+00	1.92E+07	0.00E+00	3.98E+09
TE-125M	9.66E+07	3.50E+07	1.29E+07	2.90E+07	3.93E+08	0.00E+00	3.86E+08
TE-127M	3.49E+08	1.25E+08	4.26E+07	8.93E+07	1.42E+09	0.00E+00	1.17E+09
TE-129M	2.51E+08	9.37E+07	3.97E+07	8.63E+07	1.05E+09	0.00E+00	1.26E+09
I-131	8.08E+07	1.16E+08	6.62E+07	3.79E+10	1.98E+08	0.00E+00	3.05E+07
I-133	2.09E+06	3.63E+06	1.11E+06	5.34E+08	6.33E+06	0.00E+00	3.26E+06
CS-134	4.67E+09	1.11E+10	9.08E+09	0.00E+00	3.59E+09	1.19E+09	1.94E+08
CS-136	4.28E+07	1.69E+08	1.22E+08	0.00E+00	9.41E+07	1.29E+07	1.92E+07
CS-137	6.36E+09	8.70E+09	5.70E+09	0.00E+00	2.95E+09	9.81E+08	1.68E+08
BA-140	1.29E+08	1.62E+05	8.47E+06	0.00E+00	5.52E+04	9.29E+04	2.66E+08
CE-141	1.97E+05	1.33E+05	1.51E+04	0.00E+00	6.20E+04	0.00E+00	5.10E+08
CE-144	3.29E+07	1.38E+07	1.77E+06	0.00E+00	8.16E+06	0.00E+00	1.11E+10
PR-143	6.25E+04	2.51E+04	3.10E+03	0.00E+00	1.45E+04	0.00E+00	2.74E+08
ND-147	3.34E+04	3.85E+04	2.31E+03	0.00E+00	2.25E+04	0.00E+00	1.85E+08

TABLE 2.4
PATHWAY DOSE FACTORS

AGE GROUP: TEEN		PATHWAY: VEGETATION					
NUCLIDE	ORGAN DOSE FACTORS						
	BONE	LIVER	T. BODY	THYROID	KIDNEY	LUNG	GI-LLI
H-3	0.00E+00	2.59E+03	2.59E+03	2.59E+03	2.59E+03	2.59E+03	2.59E+03
P-32	1.60E+09	9.91E+07	6.20E+07	0.00E+00	0.00E+00	0.00E+00	1.34E+08
CR-51	0.00E+00	0.00E+00	6.16E+04	3.42E+04	1.35E+04	8.79E+04	1.03E+07
MN-54	0.00E+00	4.54E+08	9.01E+07	0.00E+00	1.36E+08	0.00E+00	9.32E+08
FE-55	3.26E+08	2.31E+08	5.39E+07	0.00E+00	0.00E+00	1.47E+08	1.00E+08
FE-59	1.80E+08	4.19E+08	1.62E+08	0.00E+00	0.00E+00	1.32E+08	9.91E+08
CO-58	0.00E+00	4.36E+07	1.01E+08	0.00E+00	0.00E+00	0.00E+00	6.01E+08
CO-60	0.00E+00	2.49E+08	5.60E+08	0.00E+00	0.00E+00	0.00E+00	3.24E+09
NI-63	1.61E+10	1.13E+09	5.45E+08	0.00E+00	0.00E+00	0.00E+00	1.81E+08
ZN-65	4.24E+08	1.47E+09	6.86E+08	0.00E+00	9.42E+08	0.00E+00	6.23E+08
RB-86	0.00E+00	2.73E+08	1.28E+08	0.00E+00	0.00E+00	0.00E+00	4.04E+07
SR-89	1.52E+10	0.00E+00	4.34E+08	0.00E+00	0.00E+00	0.00E+00	1.80E+09
SR-90	7.51E+11	0.00E+00	1.85E+11	0.00E+00	0.00E+00	0.00E+00	2.11E+10
Y-91	7.84E+06	0.00E+00	2.10E+05	0.00E+00	0.00E+00	0.00E+00	3.22E+09
ZR-95	1.72E+06	5.43E+05	3.73E+05	0.00E+00	7.98E+05	0.00E+00	1.25E+09
NB-95	1.92E+05	1.07E+05	5.87E+04	0.00E+00	1.03E+05	0.00E+00	4.56E+08
RU-103	6.82E+06	0.00E+00	2.92E+06	0.00E+00	2.41E+07	0.00E+00	5.70E+08
RU-106	3.09E+08	0.00E+00	3.90E+07	0.00E+00	5.97E+08	0.00E+00	1.48E+10
AG-110M	1.52E+07	1.43E+07	8.72E+06	0.00E+00	2.74E+07	0.00E+00	4.03E+09
TE-125M	1.48E+08	5.34E+07	1.98E+07	4.14E+07	0.00E+00	0.00E+00	4.37E+08
TE-127M	5.52E+08	1.96E+08	6.56E+07	1.31E+08	2.24E+09	0.00E+00	1.37E+09
TE-129M	3.61E+08	1.34E+08	5.72E+07	1.17E+08	1.51E+09	0.00E+00	1.36E+09
I-131	7.69E+07	1.08E+08	5.78E+07	3.14E+10	1.85E+08	0.00E+00	2.13E+07
I-133	1.94E+06	3.29E+06	1.00E+06	4.59E+08	5.77E+06	0.00E+00	2.49E+06
CS-134	7.10E+09	1.67E+10	7.75E+09	0.00E+00	5.31E+09	2.03E+09	2.08E+08
CS-136	4.39E+07	1.73E+08	1.16E+08	0.00E+00	9.41E+07	1.48E+07	1.39E+07
CS-137	1.01E+10	1.35E+10	4.69E+09	0.00E+00	4.59E+09	1.78E+09	1.92E+08
BA-140	1.39E+08	1.71E+05	8.97E+06	0.00E+00	5.78E+04	1.15E+05	2.15E+08
CE-141	2.83E+05	1.89E+05	2.17E+04	0.00E+00	8.90E+04	0.00E+00	5.41E+08
CE-144	5.28E+07	2.18E+07	2.83E+06	0.00E+00	1.30E+07	0.00E+00	1.33E+10
PR-143	6.99E+04	2.79E+04	3.48E+03	0.00E+00	1.62E+04	0.00E+00	2.30E+08
ND-147	3.62E+04	3.94E+04	2.36E+03	0.00E+00	2.31E+04	0.00E+00	1.42E+08

TABLE 2.4
PATHWAY DOSE FACTORS

AGE GROUP: CHILD		PATHWAY: VEGETATION					
NUCLIDE	ORGAN DOSE FACTORS						
	BONE	LIVER	T. BODY	THYROID	KIDNEY	LUNG	GI-LLI
H-3	0.00E+00	4.02E+03	4.02E+03	4.02E+03	4.02E+03	4.02E+03	4.02E+03
P-32	3.35E+09	1.57E+08	1.29E+08	0.00E+00	0.00E+00	0.00E+00	9.25E+07
CR-51	0.00E+00	0.00E+00	1.17E+05	6.49E+04	1.77E+04	1.18E+05	6.20E+06
MN-54	0.00E+00	6.65E+08	1.77E+08	0.00E+00	1.86E+08	0.00E+00	5.58E+08
FE-55	8.01E+08	4.25E+08	1.32E+08	0.00E+00	0.00E+00	2.40E+08	7.87E+07
FE-59	3.98E+08	6.44E+08	3.21E+08	0.00E+00	0.00E+00	1.87E+08	6.71E+08
CO-58	0.00E+00	6.44E+07	1.97E+08	0.00E+00	0.00E+00	0.00E+00	3.76E+08
CO-60	0.00E+00	3.78E+08	1.12E+09	0.00E+00	0.00E+00	0.00E+00	2.10E+09
NI-63	3.95E+10	2.11E+09	1.34E+09	0.00E+00	0.00E+00	0.00E+00	1.42E+08
ZN-65	8.12E+08	2.16E+09	1.35E+09	0.00E+00	1.36E+09	0.00E+00	3.80E+08
RB-86	0.00E+00	4.51E+08	2.77E+08	0.00E+00	0.00E+00	0.00E+00	2.90E+07
SR-89	3.60E+10	0.00E+00	1.03E+09	0.00E+00	0.00E+00	0.00E+00	1.39E+09
SR-90	1.24E+12	0.00E+00	3.15E+11	0.00E+00	0.00E+00	0.00E+00	1.67E+10
Y-91	1.87E+07	0.00E+00	4.99E+05	0.00E+00	0.00E+00	0.00E+00	2.49E+09
ZR-95	3.86E+06	8.48E+05	7.55E+05	0.00E+00	1.21E+06	0.00E+00	8.85E+08
NB-95	4.11E+05	1.60E+05	1.14E+05	0.00E+00	1.50E+05	0.00E+00	2.96E+08
RU-103	1.53E+07	0.00E+00	5.90E+06	0.00E+00	3.86E+07	0.00E+00	3.97E+08
RU-106	7.45E+08	0.00E+00	9.30E+07	0.00E+00	1.01E+09	0.00E+00	1.16E+10
AG-110M	3.21E+07	2.17E+07	1.73E+07	0.00E+00	4.04E+07	0.00E+00	2.58E+09
TE-125M	3.51E+08	9.50E+07	4.67E+07	9.84E+07	0.00E+00	0.00E+00	3.38E+08
TE-127M	1.32E+09	3.56E+08	1.57E+08	3.16E+08	3.77E+09	0.00E+00	1.07E+09
TE-129M	8.40E+08	2.35E+08	1.30E+08	2.71E+08	2.47E+09	0.00E+00	1.02E+09
I-131	1.43E+08	1.44E+08	8.18E+07	4.76E+10	2.36E+08	0.00E+00	1.28E+07
I-133	3.53E+06	4.37E+06	1.65E+06	8.12E+08	7.28E+06	0.00E+00	1.76E+06
CS-134	1.60E+10	2.63E+10	5.55E+09	0.00E+00	8.15E+09	2.93E+09	1.42E+08
CS-136	8.28E+07	2.28E+08	1.47E+08	0.00E+00	1.21E+08	1.81E+07	8.00E+06
CS-137	2.39E+10	2.29E+10	3.38E+09	0.00E+00	7.46E+09	2.68E+09	1.43E+08
BA-140	2.79E+08	2.44E+05	1.63E+07	0.00E+00	7.96E+04	1.46E+05	1.41E+08
CE-141	6.57E+05	3.28E+05	4.86E+04	0.00E+00	1.44E+05	0.00E+00	4.09E+08
CE-144	1.27E+08	3.99E+07	6.79E+06	0.00E+00	2.21E+07	0.00E+00	1.04E+10
PR-143	1.45E+05	4.36E+04	7.21E+03	0.00E+00	2.36E+04	0.00E+00	1.57E+08
ND-147	7.15E+04	5.79E+04	4.49E+03	0.00E+00	3.18E+04	0.00E+00	9.18E+07

TABLE 2.4
PATHWAY DOSE FACTORS

AGE GROUP: INFANT PATHWAY: VEGETATION

NUCLIDE	ORGAN DOSE FACTORS						
	BONE	LIVER	T. BODY	THYROID	KIDNEY	LUNG	GI-LLI
H-3	0.00E+00	0.00E+00	0.00E+00	0.00E+00	0.00E+00	0.00E+00	0.00E+00
P-32	0.00E+00	0.00E+00	0.00E+00	0.00E+00	0.00E+00	0.00E+00	0.00E+00
CR-51	0.00E+00	0.00E+00	0.00E+00	0.00E+00	0.00E+00	0.00E+00	0.00E+00
MN-54	0.00E+00	0.00E+00	0.00E+00	0.00E+00	0.00E+00	0.00E+00	0.00E+00
FE-55	0.00E+00	0.00E+00	0.00E+00	0.00E+00	0.00E+00	0.00E+00	0.00E+00
FE-59	0.00E+00	0.00E+00	0.00E+00	0.00E+00	0.00E+00	0.00E+00	0.00E+00
CO-58	0.00E+00	0.00E+00	0.00E+00	0.00E+00	0.00E+00	0.00E+00	0.00E+00
CO-60	0.00E+00	0.00E+00	0.00E+00	0.00E+00	0.00E+00	0.00E+00	0.00E+00
NI-63	0.00E+00	0.00E+00	0.00E+00	0.00E+00	0.00E+00	0.00E+00	0.00E+00
ZN-65	0.00E+00	0.00E+00	0.00E+00	0.00E+00	0.00E+00	0.00E+00	0.00E+00
RB-86	0.00E+00	0.00E+00	0.00E+00	0.00E+00	0.00E+00	0.00E+00	0.00E+00
SR-89	0.00E+00	0.00E+00	0.00E+00	0.00E+00	0.00E+00	0.00E+00	0.00E+00
SR-90	0.00E+00	0.00E+00	0.00E+00	0.00E+00	0.00E+00	0.00E+00	0.00E+00
Y-91	0.00E+00	0.00E+00	0.00E+00	0.00E+00	0.00E+00	0.00E+00	0.00E+00
ZR-95	0.00E+00	0.00E+00	0.00E+00	0.00E+00	0.00E+00	0.00E+00	0.00E+00
NB-95	0.00E+00	0.00E+00	0.00E+00	0.00E+00	0.00E+00	0.00E+00	0.00E+00
RU-103	0.00E+00	0.00E+00	0.00E+00	0.00E+00	0.00E+00	0.00E+00	0.00E+00
RU-106	0.00E+00	0.00E+00	0.00E+00	0.00E+00	0.00E+00	0.00E+00	0.00E+00
AG-110M	0.00E+00	0.00E+00	0.00E+00	0.00E+00	0.00E+00	0.00E+00	0.00E+00
TE-125M	0.00E+00	0.00E+00	0.00E+00	0.00E+00	0.00E+00	0.00E+00	0.00E+00
TE-127M	0.00E+00	0.00E+00	0.00E+00	0.00E+00	0.00E+00	0.00E+00	0.00E+00
TE-129M	0.00E+00	0.00E+00	0.00E+00	0.00E+00	0.00E+00	0.00E+00	0.00E+00
I-131	0.00E+00	0.00E+00	0.00E+00	0.00E+00	0.00E+00	0.00E+00	0.00E+00
I-133	0.00E+00	0.00E+00	0.00E+00	0.00E+00	0.00E+00	0.00E+00	0.00E+00
CS-134	0.00E+00	0.00E+00	0.00E+00	0.00E+00	0.00E+00	0.00E+00	0.00E+00
CS-136	0.00E+00	0.00E+00	0.00E+00	0.00E+00	0.00E+00	0.00E+00	0.00E+00
CS-137	0.00E+00	0.00E+00	0.00E+00	0.00E+00	0.00E+00	0.00E+00	0.00E+00
BA-140	0.00E+00	0.00E+00	0.00E+00	0.00E+00	0.00E+00	0.00E+00	0.00E+00
CE-141	0.00E+00	0.00E+00	0.00E+00	0.00E+00	0.00E+00	0.00E+00	0.00E+00
CE-144	0.00E+00	0.00E+00	0.00E+00	0.00E+00	0.00E+00	0.00E+00	0.00E+00
PR-143	0.00E+00	0.00E+00	0.00E+00	0.00E+00	0.00E+00	0.00E+00	0.00E+00
ND-147	0.00E+00	0.00E+00	0.00E+00	0.00E+00	0.00E+00	0.00E+00	0.00E+00

TABLE 2.4
PATHWAY DOSE FACTORS

AGE GROUP: ADULT PATHWAY: INHALATION

NUCLIDE	ORGAN DOSE FACTORS						
	BONE	LIVER	T. BODY	THYROID	KIDNEY	LUNG	GI-LLI
H-3	0.00E+00	1.26E+03	1.26E+03	1.26E+03	1.26E+03	1.26E+03	1.26E+03
P-32	1.32E+06	7.71E+04	5.01E+04	0.00E+00	0.00E+00	0.00E+00	8.64E+04
CR-51	0.00E+00	0.00E+00	1.00E+02	5.95E+01	2.28E+01	1.44E+04	3.32E+03
MN-54	0.00E+00	3.96E+04	6.30E+03	0.00E+00	9.84E+03	1.40E+06	7.74E+04
FE-55	2.46E+04	1.70E+04	3.94E+03	0.00E+00	0.00E+00	7.21E+04	6.03E+03
FE-59	1.18E+04	2.78E+04	1.06E+04	0.00E+00	0.00E+00	1.02E+06	1.88E+05
CO-58	0.00E+00	1.58E+03	2.07E+03	0.00E+00	0.00E+00	9.28E+05	1.06E+05
CO-60	0.00E+00	1.15E+04	1.48E+04	0.00E+00	0.00E+00	5.97E+06	2.85E+05
NI-63	4.32E+05	3.14E+04	1.45E+04	0.00E+00	0.00E+00	1.78E+05	1.34E+04
ZN-65	3.24E+04	1.03E+05	4.66E+04	0.00E+00	6.90E+04	8.64E+05	5.34E+04
RB-86	0.00E+00	1.35E+05	5.90E+04	0.00E+00	0.00E+00	0.00E+00	1.66E+04
SR-89	3.04E+05	0.00E+00	8.72E+03	0.00E+00	0.00E+00	1.40E+06	3.50E+05
SR-90	9.92E+07	0.00E+00	6.10E+06	0.00E+00	0.00E+00	9.60E+06	7.22E+05
Y-91	4.62E+05	0.00E+00	1.24E+04	0.00E+00	0.00E+00	1.70E+06	3.85E+05
ZR-95	1.07E+05	3.44E+04	2.33E+04	0.00E+00	5.42E+04	1.77E+06	1.50E+05
NB-95	1.41E+04	7.82E+03	4.21E+03	0.00E+00	7.74E+03	5.05E+05	1.04E+05
RU-103	1.53E+03	0.00E+00	6.58E+02	0.00E+00	5.83E+03	5.05E+05	1.10E+05
RU-106	6.91E+04	0.00E+00	8.72E+03	0.00E+00	1.34E+05	9.36E+06	9.12E+05
AG-110M	1.08E+04	1.00E+04	5.94E+03	0.00E+00	1.97E+04	4.63E+06	3.02E+05
TE-125M	3.42E+03	1.58E+03	4.67E+02	1.05E+03	1.24E+04	3.14E+05	7.06E+04
TE-127M	1.26E+04	5.77E+03	1.57E+03	3.29E+03	4.58E+04	9.60E+05	1.50E+05
TE-129M	9.76E+03	4.67E+03	1.58E+03	3.44E+03	3.66E+04	1.16E+06	3.83E+05
I-131	2.52E+04	3.58E+04	2.05E+04	1.19E+07	6.13E+04	0.00E+00	6.28E+03
I-133	8.64E+03	1.48E+04	4.52E+03	2.15E+06	2.58E+04	0.00E+00	8.88E+03
CS-134	3.73E+05	8.48E+05	7.28E+05	0.00E+00	2.87E+05	9.76E+04	1.04E+04
CS-136	3.90E+04	1.46E+05	1.10E+05	0.00E+00	8.56E+04	1.20E+04	1.17E+04
CS-137	4.78E+05	6.21E+05	4.28E+05	0.00E+00	2.22E+05	7.52E+04	8.40E+03
BA-140	3.90E+04	4.90E+01	2.57E+03	0.00E+00	1.67E+01	1.27E+06	2.18E+05
CE-141	1.99E+04	1.35E+04	1.53E+03	0.00E+00	6.26E+03	3.62E+05	1.20E+05
CE-144	3.43E+06	1.43E+06	1.84E+05	0.00E+00	8.48E+05	7.78E+06	8.16E+05
PR-143	9.36E+03	3.75E+03	4.64E+02	0.00E+00	2.16E+03	2.81E+05	2.00E+05
ND-147	5.27E+03	6.10E+03	3.65E+02	0.00E+00	3.56E+03	2.21E+05	1.73E+05

TABLE 2.4
PATHWAY DOSE FACTORS

AGE GROUP: TEEN		PATHWAY: INHALATION					
NUCLIDE	ORGAN DOSE FACTORS						
	BONE	LIVER	T. BODY	THYROID	KIDNEY	LUNG	GI-LLI
H-3	0.00E+00	1.27E+03	1.27E+03	1.27E+03	1.27E+03	1.27E+03	1.27E+03
P-32	1.89E+06	1.10E+05	7.16E+04	0.00E+00	0.00E+00	0.00E+00	9.28E+04
CR-51	0.00E+00	0.00E+00	1.35E+02	7.50E+01	3.07E+01	2.10E+04	3.00E+03
MN-54	0.00E+00	5.11E+04	8.40E+03	0.00E+00	1.27E+04	1.98E+06	6.68E+04
FE-55	3.34E+04	2.38E+04	5.54E+03	0.00E+00	0.00E+00	1.24E+05	6.39E+03
FE-59	1.59E+04	3.70E+04	1.43E+04	0.00E+00	0.00E+00	1.53E+06	1.78E+05
CO-58	0.00E+00	2.07E+03	2.78E+03	0.00E+00	0.00E+00	1.34E+06	9.52E+04
CO-60	0.00E+00	1.51E+04	1.98E+04	0.00E+00	0.00E+00	8.72E+06	2.59E+05
NI-63	5.80E+05	4.34E+04	1.98E+04	0.00E+00	0.00E+00	3.07E+05	1.42E+04
ZN-65	3.86E+04	1.34E+05	6.24E+04	0.00E+00	8.64E+04	1.24E+06	4.66E+04
RB-86	0.00E+00	1.90E+05	8.40E+04	0.00E+00	0.00E+00	0.00E+00	1.77E+04
SR-89	4.34E+05	0.00E+00	1.25E+04	0.00E+00	0.00E+00	2.42E+06	3.71E+05
SR-90	1.08E+08	0.00E+00	6.68E+06	0.00E+00	0.00E+00	1.65E+07	7.65E+05
Y-91	6.61E+05	0.00E+00	1.77E+04	0.00E+00	0.00E+00	2.94E+06	4.09E+05
ZR-95	1.46E+05	4.58E+04	3.15E+04	0.00E+00	6.74E+04	2.69E+06	1.49E+05
NB-95	1.86E+04	1.03E+04	5.66E+03	0.00E+00	1.00E+04	7.51E+05	9.68E+04
RU-103	2.10E+03	0.00E+00	8.96E+02	0.00E+00	7.43E+03	7.83E+05	1.09E+05
RU-106	9.84E+04	0.00E+00	1.24E+04	0.00E+00	1.90E+05	1.61E+07	9.60E+05
AG-110M	1.38E+04	1.31E+04	7.99E+03	0.00E+00	2.50E+04	6.75E+06	2.73E+05
TE-125M	4.88E+03	2.24E+03	6.67E+02	1.40E+03	0.00E+00	5.36E+05	7.50E+04
TE-127M	1.80E+04	8.16E+03	2.18E+03	4.38E+03	6.54E+04	1.66E+06	1.59E+05
TE-129M	1.39E+04	6.58E+03	2.25E+03	4.58E+03	5.19E+04	1.98E+06	4.05E+05
I-131	3.54E+04	4.91E+04	2.64E+04	1.46E+07	8.40E+04	0.00E+00	6.49E+03
I-133	1.22E+04	2.05E+04	6.22E+03	2.92E+06	3.59E+04	0.00E+00	1.03E+04
CS-134	5.02E+05	1.13E+06	5.49E+05	0.00E+00	3.75E+05	1.46E+05	9.76E+03
CS-136	5.15E+04	1.94E+05	1.37E+05	0.00E+00	1.10E+05	1.78E+04	1.09E+04
CS-137	6.70E+05	8.48E+05	3.11E+05	0.00E+00	3.04E+05	1.21E+05	8.48E+03
BA-140	5.47E+04	6.70E+01	3.52E+03	0.00E+00	2.28E+01	2.03E+06	2.29E+05
CE-141	2.84E+04	1.90E+04	2.17E+03	0.00E+00	8.88E+03	6.14E+05	1.26E+05
CE-144	4.89E+06	2.02E+06	2.62E+05	0.00E+00	1.21E+06	1.34E+07	8.64E+05
PR-143	1.34E+04	5.31E+03	6.62E+02	0.00E+00	3.09E+03	4.83E+05	2.14E+05
ND-147	7.86E+03	8.56E+03	5.13E+02	0.00E+00	5.02E+03	3.72E+05	1.82E+05

TABLE 2.4
PATHWAY DOSE FACTORS

AGE GROUP: CHILD PATHWAY: INHALATION

NUCLIDE	ORGAN DOSE FACTORS						
	BONE	LIVER	T. BODY	THYROID	KIDNEY	LUNG	GI-LLI
H-3	0.00E+00	1.12E+03	1.12E+03	1.12E+03	1.12E+03	1.12E+03	1.12E+03
P-32	2.60E+06	1.14E+05	9.88E+04	0.00E+00	0.00E+00	0.00E+00	4.22E+04
CR-51	0.00E+00	0.00E+00	1.54E+02	8.55E+01	2.43E+01	1.70E+04	1.08E+03
MN-54	0.00E+00	4.29E+04	9.51E+03	0.00E+00	1.00E+04	1.58E+06	2.29E+04
FE-55	4.74E+04	2.52E+04	7.77E+03	0.00E+00	0.00E+00	1.11E+05	2.87E+03
FE-59	2.07E+04	3.34E+04	1.67E+04	0.00E+00	0.00E+00	1.27E+06	7.07E+04
CO-58	0.00E+00	1.77E+03	3.16E+03	0.00E+00	0.00E+00	1.11E+06	3.44E+04
CO-60	0.00E+00	1.31E+04	2.26E+04	0.00E+00	0.00E+00	7.07E+06	9.62E+04
NI-63	8.21E+05	4.63E+04	2.80E+04	0.00E+00	0.00E+00	2.75E+05	6.33E+03
ZN-65	4.26E+04	1.13E+05	7.03E+04	0.00E+00	7.14E+04	9.95E+05	1.63E+04
RB-86	0.00E+00	1.98E+05	1.14E+05	0.00E+00	0.00E+00	0.00E+00	7.99E+03
SR-89	5.99E+05	0.00E+00	1.72E+04	0.00E+00	0.00E+00	2.16E+06	1.67E+05
SR-90	1.01E+08	0.00E+00	6.44E+06	0.00E+00	0.00E+00	1.48E+07	3.43E+05
Y-91	9.14E+05	0.00E+00	2.44E+04	0.00E+00	0.00E+00	2.63E+06	1.84E+05
ZR-95	1.90E+05	4.18E+04	3.70E+04	0.00E+00	5.96E+04	2.23E+06	6.11E+04
NB-95	2.35E+04	9.18E+03	6.55E+03	0.00E+00	8.62E+03	6.14E+05	3.70E+04
RU-103	2.79E+03	0.00E+00	1.07E+03	0.00E+00	7.03E+03	6.62E+05	4.48E+04
RU-106	1.36E+05	0.00E+00	1.69E+04	0.00E+00	1.84E+05	1.43E+07	4.29E+05
AG-110M	1.69E+04	1.14E+04	9.14E+03	0.00E+00	2.12E+04	5.48E+06	1.00E+05
TE-125M	6.73E+03	2.33E+03	9.14E+02	1.92E+03	0.00E+00	4.77E+05	3.38E+04
TE-127M	2.49E+04	8.55E+03	3.02E+03	6.07E+03	6.36E+04	1.48E+06	7.14E+04
TE-129M	1.92E+04	6.85E+03	3.04E+03	6.33E+03	5.03E+04	1.76E+06	1.82E+05
I-131	4.81E+04	4.81E+04	2.73E+04	1.62E+07	7.88E+04	0.00E+00	2.84E+03
I-133	1.66E+04	2.03E+04	7.70E+03	3.85E+06	3.38E+04	0.00E+00	5.48E+03
CS-134	6.51E+05	1.01E+06	2.25E+05	0.00E+00	3.30E+05	1.21E+05	3.85E+03
CS-136	6.51E+04	1.71E+05	1.16E+05	0.00E+00	9.55E+04	1.45E+04	4.18E+03
CS-137	9.07E+05	8.25E+05	1.28E+05	0.00E+00	2.82E+05	1.04E+05	3.62E+03
BA-140	7.40E+04	6.48E+01	4.33E+03	0.00E+00	2.11E+01	1.74E+06	1.02E+05
CE-141	3.92E+04	1.95E+04	2.90E+03	0.00E+00	8.55E+03	5.44E+05	5.66E+04
CE-144	6.77E+06	2.12E+06	3.61E+05	0.00E+00	1.17E+06	1.20E+07	3.89E+05
PR-143	1.85E+04	5.55E+03	9.14E+02	0.00E+00	3.00E+03	4.33E+05	9.73E+04
ND-147	1.08E+04	8.73E+03	6.81E+02	0.00E+00	4.81E+03	3.28E+05	8.21E+04

TABLE 2.4
PATHWAY DOSE FACTORS

AGE GROUP: INFANT PATHWAY: INHALATION

NUCLIDE	ORGAN DOSE FACTORS						
	BONE	LIVER	T. BODY	THYROID	KIDNEY	LUNG	GI-LLI
H-3	0.00E+00	6.47E+02	6.47E+02	6.47E+02	6.47E+02	6.47E+02	6.47E+02
P-32	2.03E+06	1.12E+05	7.74E+04	0.00E+00	0.00E+00	0.00E+00	1.61E+04
CR-51	0.00E+00	0.00E+00	8.95E+01	5.75E+01	1.32E+01	1.28E+04	3.57E+02
MN-54	0.00E+00	2.53E+04	4.98E+03	0.00E+00	4.98E+03	1.00E+06	7.06E+03
FE-55	1.97E+04	1.17E+04	3.33E+03	0.00E+00	0.00E+00	8.69E+04	1.09E+03
FE-59	1.36E+04	2.35E+04	9.48E+03	0.00E+00	0.00E+00	1.02E+06	2.48E+04
CO-58	0.00E+00	1.22E+03	1.82E+03	0.00E+00	0.00E+00	7.77E+05	1.11E+04
CO-60	0.00E+00	8.02E+03	1.18E+04	0.00E+00	0.00E+00	4.51E+06	3.19E+04
NI-63	3.39E+05	2.04E+04	1.16E+04	0.00E+00	0.00E+00	2.09E+05	2.42E+03
ZN-65	1.93E+04	6.26E+04	3.11E+04	0.00E+00	3.25E+04	6.47E+05	5.14E+04
RB-86	0.00E+00	1.90E+05	8.82E+04	0.00E+00	0.00E+00	0.00E+00	3.04E+03
SR-89	3.98E+05	0.00E+00	1.14E+04	0.00E+00	0.00E+00	2.03E+06	6.40E+04
SR-90	4.09E+07	0.00E+00	2.59E+06	0.00E+00	0.00E+00	1.12E+07	1.31E+05
Y-91	5.88E+05	0.00E+00	1.57E+04	0.00E+00	0.00E+00	2.45E+06	7.03E+04
ZR-95	1.15E+05	2.79E+04	2.03E+04	0.00E+00	3.11E+04	1.75E+06	2.17E+04
NB-95	1.57E+04	6.43E+03	3.78E+03	0.00E+00	4.72E+03	4.79E+05	1.27E+04
RU-103	2.02E+03	0.00E+00	6.79E+02	0.00E+00	4.24E+03	5.52E+05	1.61E+04
RU-106	8.68E+04	0.00E+00	1.09E+04	0.00E+00	1.07E+05	1.16E+07	1.64E+05
AG-110M	9.98E+03	7.22E+03	5.00E+03	0.00E+00	1.09E+04	3.67E+06	3.30E+04
TE-125M	4.76E+03	1.99E+03	6.58E+02	1.62E+03	0.00E+00	4.47E+05	1.29E+04
TE-127M	1.67E+04	6.90E+03	2.07E+03	4.87E+03	3.75E+04	1.31E+06	2.73E+04
TE-129M	1.41E+04	6.09E+03	2.23E+03	5.47E+03	3.18E+04	1.68E+06	6.90E+04
I-131	3.79E+04	4.44E+04	1.96E+04	1.48E+07	5.18E+04	0.00E+00	1.06E+03
I-133	1.32E+04	1.92E+04	5.60E+03	3.56E+06	2.24E+04	0.00E+00	2.16E+03
CS-134	3.96E+05	7.03E+05	7.45E+04	0.00E+00	1.90E+05	7.97E+04	1.33E+03
CS-136	4.83E+04	1.35E+05	5.29E+04	0.00E+00	5.64E+04	1.18E+04	1.43E+03
CS-137	5.49E+05	6.12E+05	4.55E+04	0.00E+00	1.72E+05	7.13E+04	1.33E+03
BA-140	5.60E+04	5.60E+01	2.90E+03	0.00E+00	1.34E+01	1.60E+06	3.84E+04
CE-141	2.77E+04	1.67E+04	1.99E+03	0.00E+00	5.25E+03	5.17E+05	2.16E+04
CE-144	3.19E+06	1.21E+06	1.76E+05	0.00E+00	5.38E+05	9.84E+06	1.48E+05
PR-143	1.40E+04	5.24E+03	6.99E+02	0.00E+00	1.97E+03	4.33E+05	3.72E+04
ND-147	7.94E+03	8.13E+03	5.00E+02	0.00E+00	3.15E+03	3.22E+05	3.12E+04

CONTROLLING RECEPTOR PATHWAYS AND LOCATIONS (NOTE 1), AND
ATMOSPHERIC DISPERSION PARAMETERS (FOR DOSE CALCULATIONS
REQUIRED BY RADIOLOGICAL EFFLUENT CONTROL 3/4.11.2.3)

TABLE RELOCATED:

CURRENT INFORMATION LISTED AND MAINTAINED
CURRENT IN RESULTS OF ANNUAL LAND USE CENSUS

THIS PAGE INTENTIONALLY LEFT BLANK

GASEOUS WASTE PROCESSING SYSTEM

FIGURE 2.1

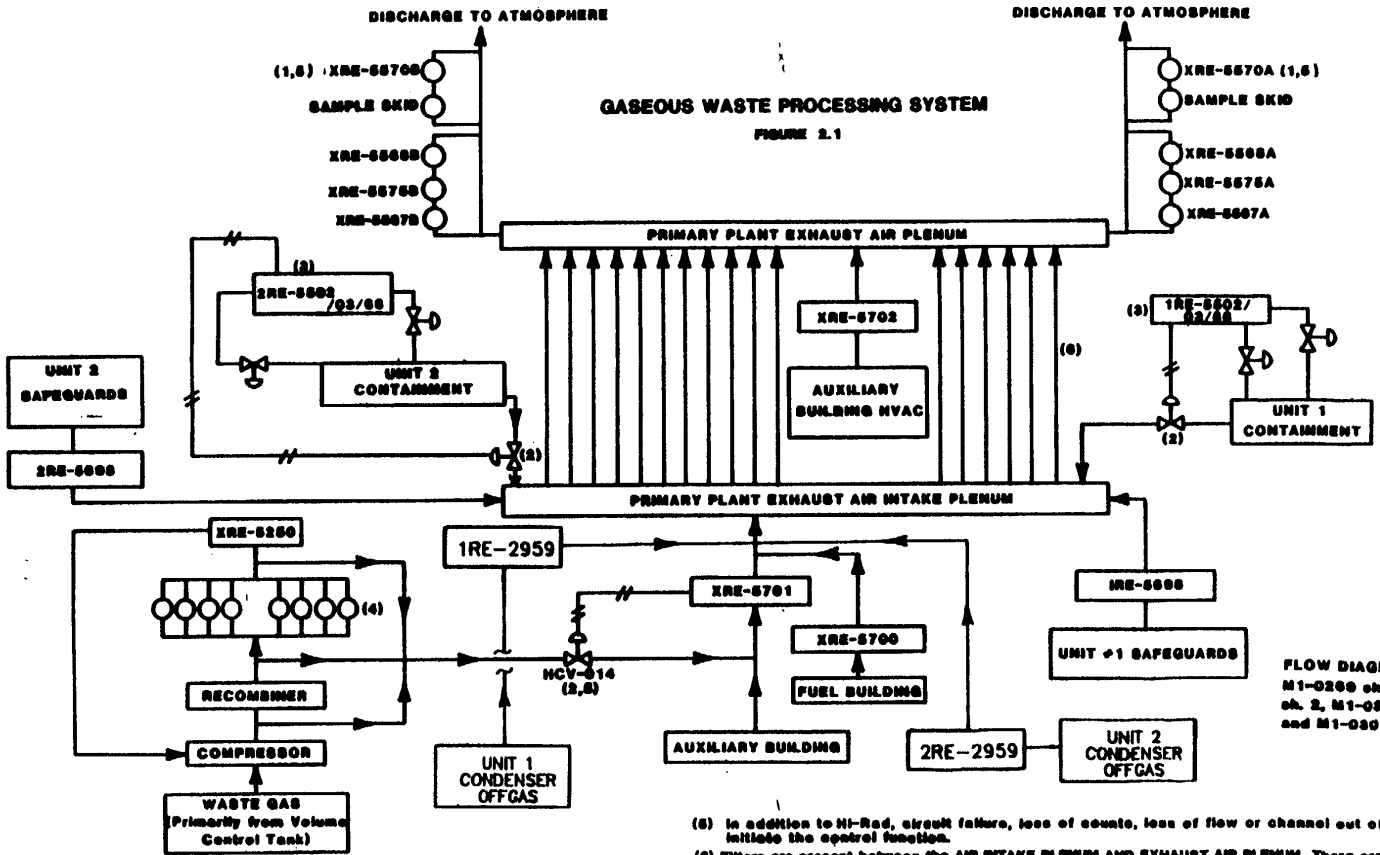

FLOW DIAGRAMS:
M1-0200 ch. 1, M1-0270
ch. 2, M1-0302, M1-0303
and M1-0308

- (1) Wide Range Gas Monitor, Hi-Red indication closes valve HCV-014 (Waste Gas Release).
- (2) Hi-Red indication by monitor closes valve.
- (3) Hi-Red indication initiates containment isolation.
- (4) Eight gaseous decay tanks can be individually purged (There are two additional tanks for shutdown).

- (5) In addition to Hi-Red, circuit failure, loss of counts, loss of flow or channel out of service will initiate the control function.
- (6) Filters are present between the AIR INTAKE PLENUM AND EXHAUST AIR PLENUM. There are sixteen banks of filters divided into TRAIN A and TRAIN B. Each bank consists of a carbon filter, a HEPA filter, a carbon filter, and a HEPA filter in series.

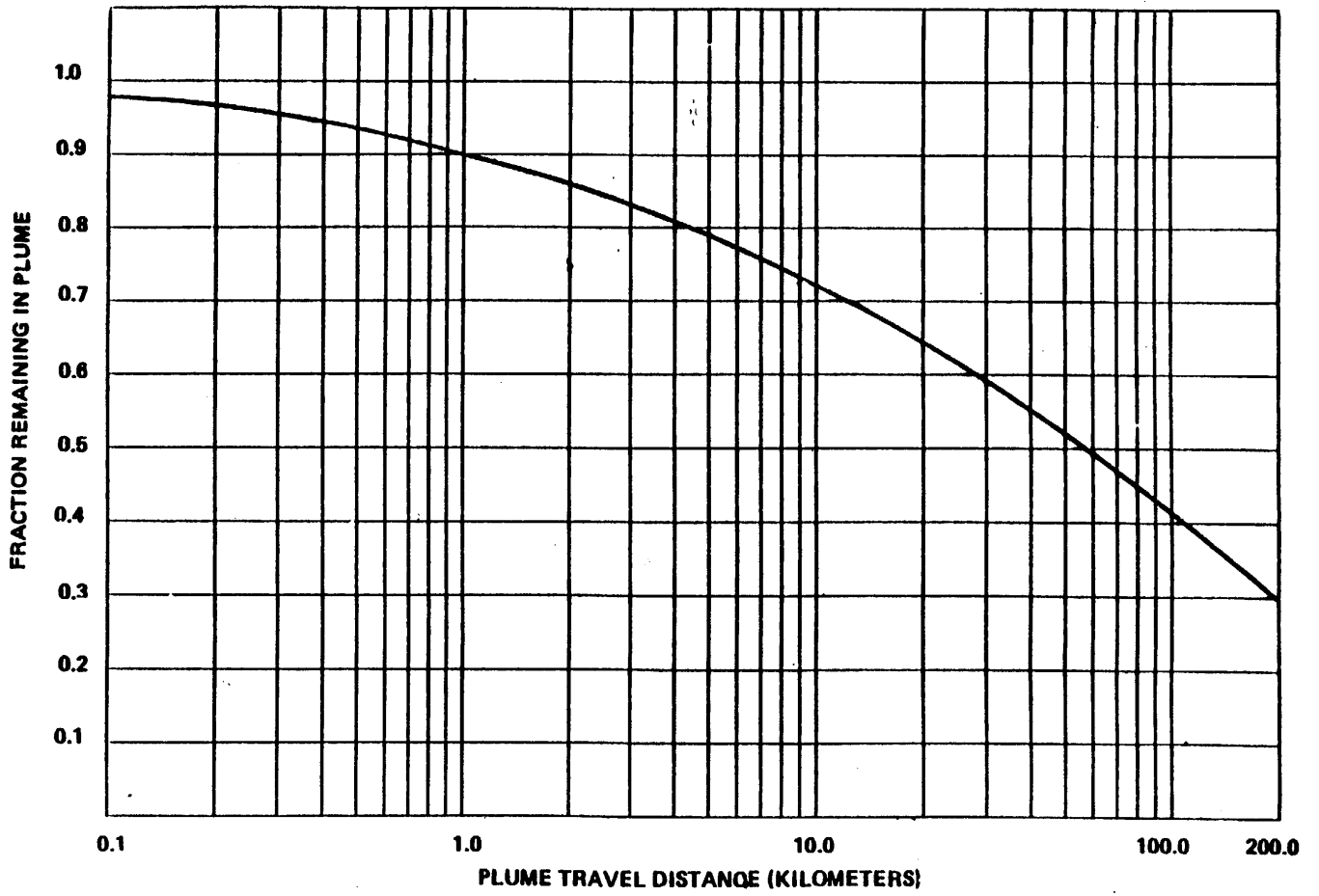

Plume Depletion Effect for Ground-Level Releases (All Atmospheric Stability Classes)

Figure 2.2

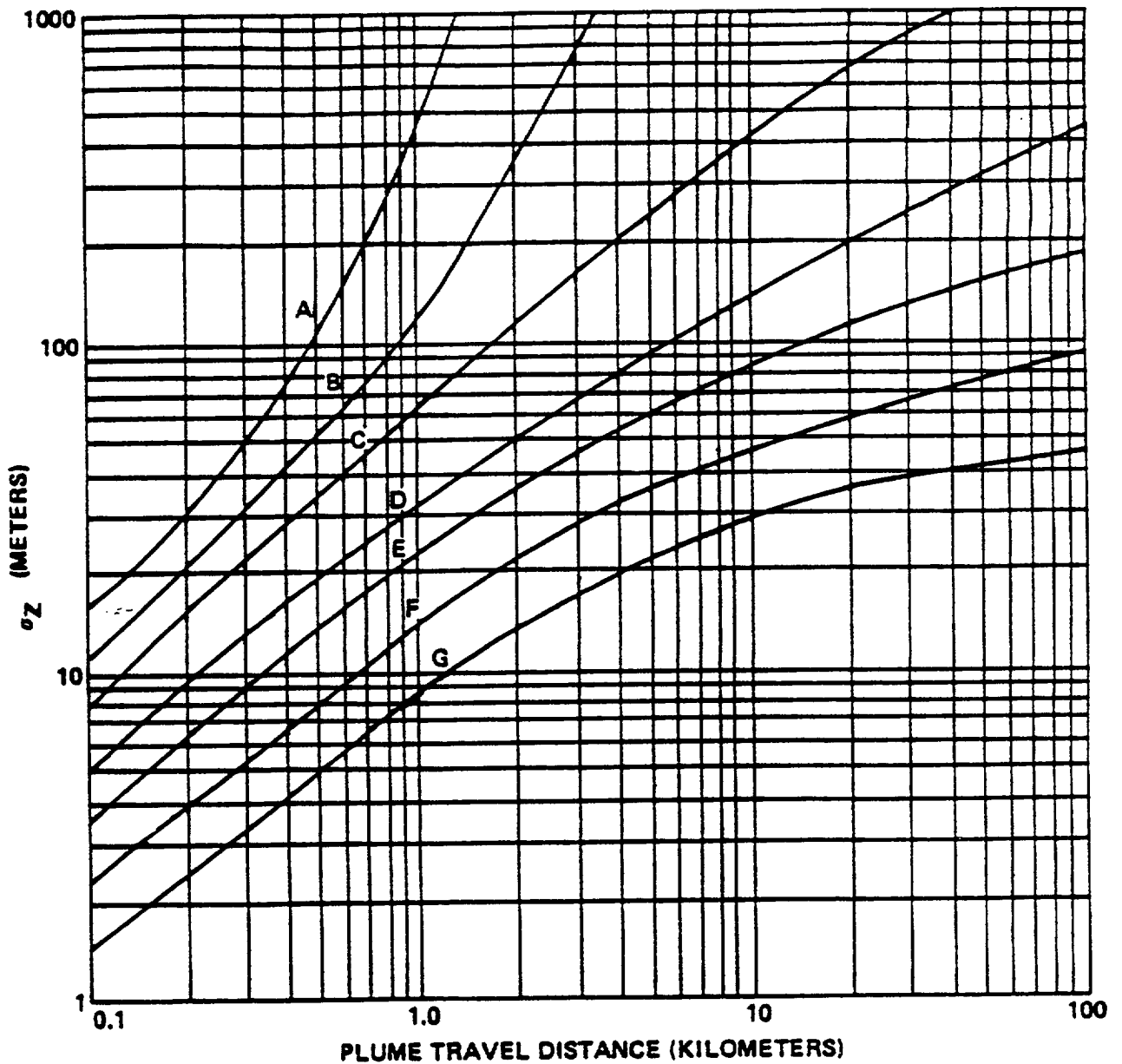

Vertical Standard Deviation of Material in a Plume (Letters denote Pasquill Stability Class)

NOTE: THESE ARE STANDARD RELATIONSHIPS AND MAY HAVE TO BE MODIFIED FOR CERTAIN TYPES OF TERRAIN AND/OR CLIMATIC CONDITIONS (E.G., VALLEY, DESERT, OVER WATER).

Figure 2.3

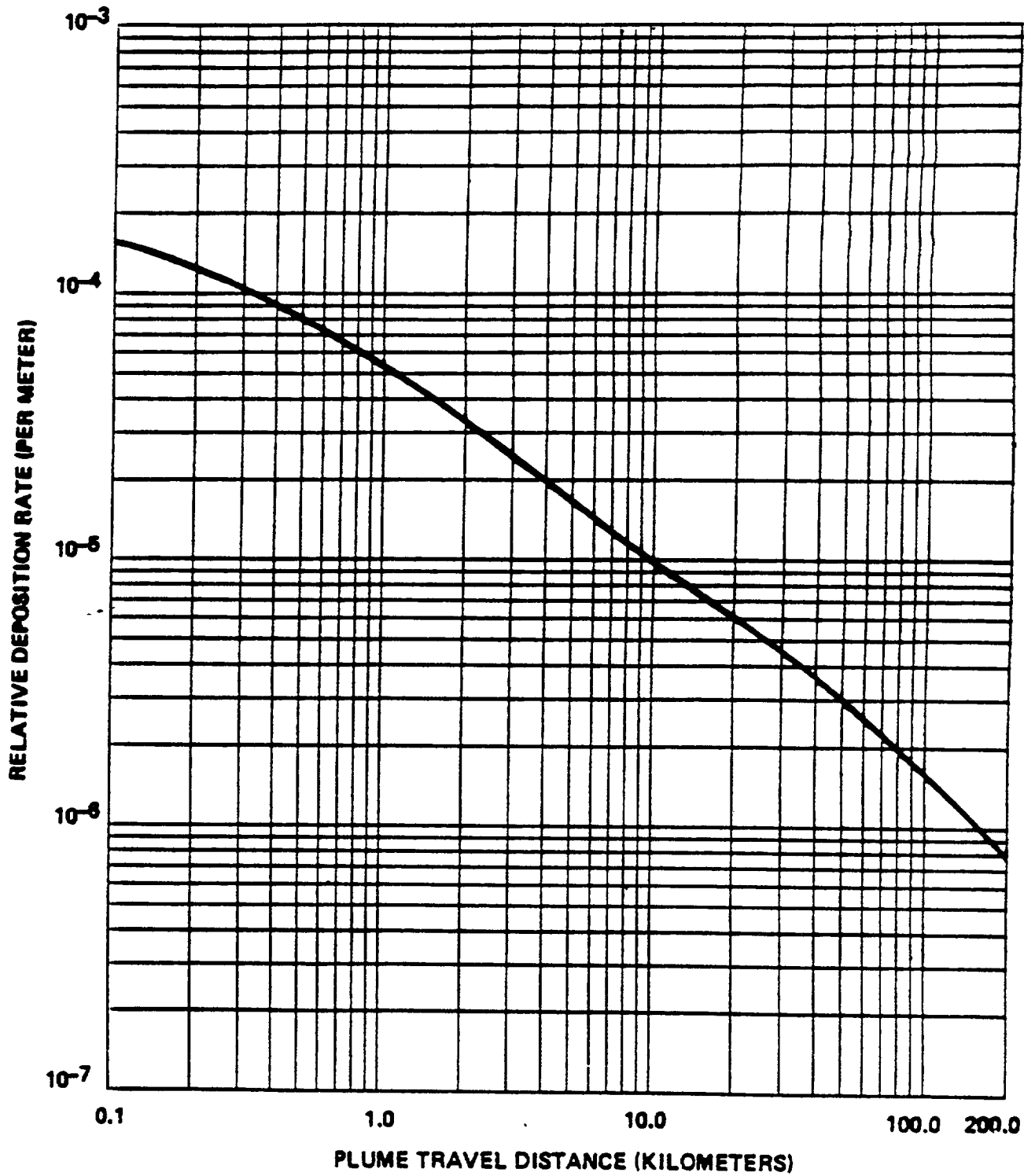

Relative Deposition for Ground-Level Releases (All Atmospheric Stability Classes)

Figure 2.4

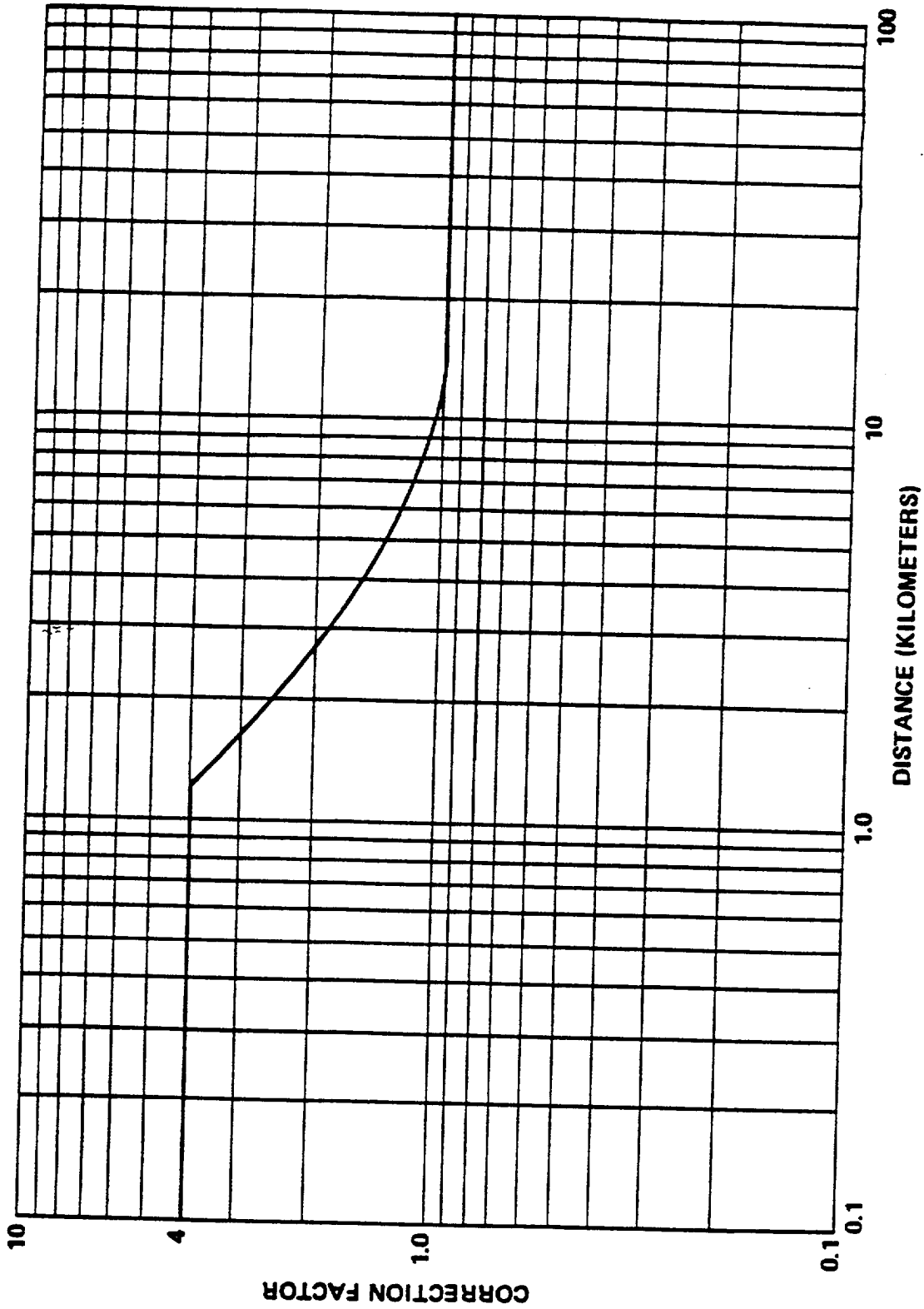

Open Terrain Correction Factor
Figure 2.5

SECTION 3.0

RADIOLOGICAL ENVIRONMENTAL MONITORING

3.1 SAMPLING LOCATIONS

Sampling locations as required in Radiological Effluent Control 3/4.12.1, Table 3.12-1 are listed and maintained current in the results of the annual Land Use Census.

12

NOTE: For the purpose of implementing Radiological Effluent Control 3/4.12.1, sampling locations will be modified as required to reflect the findings of the Land Use Census. Dose calculations used in making this determination will be performed as specified in Section 2.5.

8

The sampling locations maintained in the results of the annual Land Use Census are the minimum locations required for compliance with Radiological Effluent Control 3/4.12.1. If desired, additional locations may be monitored as special studies to evaluate potential pathways of exposure without adding such locations to the monitoring program.

12

3.2 INTERLABORATORY COMPARISON PROGRAM

For the purpose of implementing Radiological Effluent Control 3/4.12.3, TXU Electric has contracted with an outside laboratory to provide radiological environmental analytical services with required participation in an Interlaboratory Comparison Program. The Interlaboratory Comparison Program is conducted by a third-party laboratory which supplies environmental-type samples (e.g., milk or water) containing concentrations of radionuclides known to the issuing laboratory but not to the participant laboratories. The purpose of the program is to provide an independent check on the participant laboratory's analytical procedures and to alert the participants to any possible problems. Participant laboratories measure the concentrations of specified radionuclides and report them to the issuing laboratory. Several months later, the issuing laboratory reports the known values to the

16

12

participant laboratories and specifies control limits. Results consistently higher or lower than the known values or outside the control limits indicate a need to check the instruments or procedures used.

12

TXU Electric's contracted outside laboratory participates in an environmental sample crosscheck program for representative sample media. The results of the program are included in the Annual Radiological Environmental Operating Report, as required by CPSES ODCM Section 6.9.1.3.

16

TABLE 3.1

ENVIRONMENTAL SAMPLING LOCATIONS

TABLE RELOCATED;

12

ENVIRONMENTAL SAMPLING LOCATIONS ARE LISTED AND MAINTAINED
CURRENT IN THE RESULTS OF THE ANNUAL
LAND USE CENSUS

RADIOLOGICAL ENVIRONMENTAL
MONITORING LOCATIONS

FIGURE RELOCATED;

12

RADIOLOGICAL ENVIRONMENTAL MONITORING LOCATIONS ARE LISTED
AND MAINTAINED CURRENT IN THE RESULTS OF THE ANNUAL
LAND USE CENSUS

APPENDIX A
PATHWAY DOSE RATE PARAMETER

$$P_i \text{ (inhalation)} = K' (BR) DFA_i \quad [\text{Eq. A-1}]$$

where:

- P_i = the pathway dose rate parameter for radionuclide, i , (other than noble gases) for the inhalation pathway, in mrem/yr per microcurie/ m^3 . The dose factors are based on the critical individual organ for the child age group.
- K' = conversion factor, 10^6 pCi/microcurie
- BR = 3700 m^3 /yr, breathing rate for child (Ref. 2, Table E-5)
- DFA_i = the maximum organ inhalation dose factor for the child age group for the i th radionuclide (mRem/pCi). Values are taken from Table E-9, Reg. Guide 1.109 (Ref. 2)

Resolution of the units yields:

$$P_i \text{ (inhalation)} = 3.7 \times 10^9 DFA_i \text{ (mRem/yr per } \mu\text{Ci}/m^3) \quad [\text{Eq. A-2}]$$

The latest NRC Guidance has deleted the requirement to determine P_i (ground plane) and P_i (food). In addition, the critical age group has been changed from infant to child.

APPENDIX B

INHALATION PATHWAY DOSE FACTOR ($R_{i,a,o}^I$)

$$R_{i,a,o}^I = k' (BR) (DFA_{i,a,o}) \text{ (mrem/yr per microcurie/m}^3\text{)} \text{ [Eq. B-1]}$$

where:

k' = conversion factor, 10^6 pCi/microcurie

BR = breathing rate, 1400, 3700, 8000, and 8000 m^3 /yr for infant, child, teenager, and adult age groups, respectively. (Ref. 2, Table E-5)

$DFA_{i,a,o}$ = the inhalation dose factor for organ, o, of the receptor of a given age group, a, and for the i th radionuclide, in mrem/pCi. The total body is considered as an organ in the selection of $DFA_{i,a,o}$. Values are taken from Tables E-7 through E-10, Reg. Guide 1.109 (Ref.2)

APPENDIX C

GROUND PLANE PATHWAY DOSE FACTOR (R_i^G)

$$R_i^G = k' k'' (SF) DFG_i \left[\frac{(1 - e^{-\lambda_i t})}{\lambda_i} \right] \quad [\text{Eq. C-1}]$$

where:

- k' = conversion factor, 10^6 pCi/microcurie
- k'' = conversion factor, 8760 hr/yr
- λ_i = decay constant for the i th radionuclide, sec^{-1}
- t = the exposure time (this calculation assumes that decay is the only operating removal mechanism) 4.73×10^8 sec. (15 yrs)
- DFG_i = the ground plane dose conversion factor for the i th radionuclide (mrem/hr per pCi/m²). Values are taken from Table E-6, Reg. Guide 1.109 (Ref. 2). These values apply to all age groups. Dose factors are provided for the total body and skin only. Doses to all other organs are assumed equal to the total body dose.
- SF = 0.7, shielding factor, from Table E-15, Reg. Guide 1.109 (Ref. 2)

1

APPENDIX D

GRASS COW-MILK PATHWAY DOSE FACTOR ($R_{i,a,o}^C$)

$$R_{i,a,o}^C = k' [(Q_F \times U_{AP}) / (\lambda_1 + \lambda_w)] \times (F_m) \times (r) \times (DFL_{i,a,o}) \times [((f_p \times f_s) / Y_p) + ((1-f_p \times f_s) e^{-\lambda_i t_h}) / Y_s] e^{-\lambda_i t_f} \quad [\text{Eq. D-1}]$$

where:

- k' = conversion factor, 10^6 picocurie/microcurie (pCi/uci)
- Q_F = cow consumption rate, 50 kg/day, (R.G. 1.109)
- U_{AP} = Receptor's milk consumption rate; 330, 330, 400, 310 liters/yr for infant, child, teenager, and adult age groups, respectively (R.G. 1.109)
- Y_p = agricultural productivity by unit area of pasture feed grass, 0.7 kg/m^2 (NUREG-0133)
- Y_s = agricultural productivity by unit area of stored feed, 2.0 kg/m^2 , (NUREG 0133)
- F_m = stable element transfer coefficient (Table E-1, R.G. 1.109)
- r = fraction of deposited activity retained in cow's feed grass, 0.2 for particulates, 1.0 for radioiodine (Table E-15, R.G. 1.109)
- $DFL_{i,a,o}$ = the ingestion dose factor for organ, o, and the ith radionuclide for each respective age group, a (Tables E-11 to E-14, R.G. 1.109)
- λ_i = decay constant for the ith radionuclide, sec^{-1}
- λ_w = decay constant for weathering, $5.73 \times 10^{-7} \text{ sec}^{-1}$ (NUREG-0133)
- t_f = 1.73×10^5 sec, the transport time from pasture to cow to milk to receptor (Table E-15, R.G. 1.109)

APPENDIX D (CONTINUED)

- t_h = 7.78×10^6 sec, the transport time from pasture to harvest to cow to milk to receptor (Table E-15, R.G. 1.109)
- f_p = 1.0, the fraction of the year that the cow is on pasture.
- f_s = 1.0, the fraction of the cow feed that is pasture grass while the cow is on pasture.

The concentration of tritium in milk is based on the airborne concentration rather than the deposition. Therefore, $R_{i,a,o}^C$ is based on (X/Q):

$$R_{t,a,o}^C = k' k''' F_m Q_F U_{AP} DFL_{t,a,o} (.75 (.5/H)) \quad [\text{Eq. D-2}]$$

where:

- $k' k'''$ = 10^3 grams/kg
- H = 8 grams/m³, absolute humidity of the atmosphere
- .75 = fraction of total feed grass mass that is water
- .5 = ratio of the specific activity of the feed grass water to the atmospheric water. (NUREG-0133)
- $DFL_{t,a,o}$ = the ingestion dose factor for tritium and organ, o, for each respective age group, a (Tables E-11 to E-14, R.G. 1.109)

All other parameters and values are as given above.

NOTE: Goat-milk pathway factor, $R_{i,a,o}^C$ will be computed using the cow-milk pathway factor equation. F_m factor for goat-milk will be from Table E-2, R.G. 1.109. Q_F for goats is 6 kg/day from Table E-3, R. G. 1.109

APPENDIX E

COW-MEAT PATHWAY DOSE FACTOR ($R_{i,a,o}^M$)

$$R_{i,a,o}^M = k' (Q_F \times U_{AP}) / (\lambda_i + \lambda_w) \times (F_f) \times (r) \times (DFL_{i,a,o}) \times [((f_p \times f_s) / Y_p) + ((1 - f_p f_s) e^{-\lambda_i t_h} / Y_s)] \times e^{-\lambda_i t_f}$$

[Eq. E-1]

where:

- k' = conversion factor, 10^6 picocurie/microcurie (pCi/uCi)
- Q_F = cow consumption rate, 50 kg/day, (R.G. 1.109)
- U_{AP} = Receptor's meat consumption rate; 0, 41, 65, 110 kg/yr for infant, child, teenager, and adult age groups, respectively (R.G. 1.109)
- F_f = the stable element transfer coefficients, days/kg. (Table E-1, R.G. 1.109)
- r = fraction of deposited activity retained in cow's feed grass, 0.2 for particulates, 1.0 for radioiodine (Table E-15, R.G. 1.109)
- $DFL_{i,a,o}$ = the ingestion dose factor for organ, o, and the ith radionuclide for each respective age group, a (Tables E-11 to E-14, R.G. 1.109)
- λ_i = decay constant for radionuclide i, sec^{-1}
- λ_w = decay constant for weathering, $5.73 \times 10^{-7} \text{ sec}^{-1}$ (NUREG-0133)
- t_f = 1.73×10^6 sec, the transport time from pasture to receptor (NUREG-0133)
- t_h = 7.78×10^6 sec, the transport time from crop to receptor (NUREG-0133)

APPENDIX E (CONTINUED)

- Y_p = agricultural productivity by unit area of pasture feed grass, 0.7 kg/m^2 (NUREG-0133)
 Y_s = agricultural productivity by unit area of stored feed, 2.0 kg/m^2 , (NUREG 0133)
 f_p = 1.0, the fraction of the year that the cow is on pasture.
 f_s = 1.0, the fraction of the cow feed that is pasture grass while the cow is on pasture.

The concentration of tritium in meat is based on its airborne concentration rather than the deposition. Therefore R_{f}^M is based on (X/Q):

$$R_{t,a,o}^M = k'k''' F_f Q_F U_{AP} (DFL_{t,a,o}) \times 0.75 \times (0.5/H) \quad [\text{Eq. E-2}]$$

where:

All terms are as defined above and in Appendix D.

APPENDIX F

VEGETATION PATHWAY DOSE FACTOR ($R_{i,a,o}^V$)

$$R_{i,a,o}^V = k' \times [r / (Y_v (\lambda_i + \lambda_w))] \times (DFL_{i,a,o}) \times [(U_A^L) f_L e^{-\lambda_i t_L} + U_A^S f_g e^{-\lambda_i t_h}] \quad [\text{Eq. F-1}]$$

where:

- k' = 10^6 picocurie/microcurie (pCi/uCi)
- U_A^L = the consumption rate of fresh leafy vegetation, 0, 26, 42, 64kg/yr for infant, child, teenager, or adult age groups respectively. (R.G. 1.109)
- U_A^S = the consumption rate of stored vegetation, 0, 520, 630, 520 kg/yr for infant, child, teenager, or adult age groups respectively. (R.G. 1.109)
- f_L = the fraction of the annual intake of fresh leafy vegetation grown locally, 1.0 (NUREG-0133)
- f_g = the fraction of the stored vegetation grown locally .76 (NUREG-0133)
- t_L = the average time between harvest of leafy vegetation and its consumption, 8.6×10^4 seconds (Table E-15, R.G. 1.109 (24 hrs))
- t_h = the average time between harvest of stored leafy vegetation and its consumption, 5.18×10^6 seconds (Table E-15, R.G. 1.109 (60 days))

APPENDIX F (CONTINUED)

y_v = the vegetation areal density, 2.0 kg/m² (Table E-15, R.G. 1.109)

8

All other parameters are as previously defined.

The concentration of tritium in vegetation is based on the airborne concentration rather than the deposition. Therefore, R_{i}^V is based on (X/Q)

$$R_{t,a,o}^V = k'k''' [U_A^L f_L + U_A^S f_g] (DFL_{t,a,o}) (.75 (.5/H)) \text{ [Eq. F-2]}$$

where:

All terms are as defined above and in Appendix D.

APPENDIX G

SUPPLEMENTAL GUIDANCE STATEMENTS

HAVE BEEN DELETED

| 8

Office Memorandum



atory Affairs
anche Peak Steam Electric Station
ES-199904441

Date: December 17, 1999
To: ODCM COPY HOLDERS
Re: COMANCHE PEAK STEAM ELECTRIC STATION (CPSES)
REVISION 18 TO THE CPSES OFFSITE DOSE CALCULATION
MANUAL (ODCM)

Enclosed is Revision 18 to the CPSES Offsite Dose Calculation Manual (ODCM) and receipt acknowledgment sheet as specified. This change is effective on December 20, 1999.

If you should have any questions regarding the ODCM, please contact Connie Wilkerson at (254)897-0144..

A handwritten signature in cursive script, appearing to read "D. E. Buschbaum".

D. E. Buschbaum
Docket Licensing Manager

CLW/jrh
Attachment
Enclosure

c - CCG E06
File 953

Preparer: Connie L. Wilkerson
Connie L. Wilkerson

Proof Reader: [Handwritten Signature]

**COMANCHE PEAK STEAM ELECTRIC STATION
OFFSITE DOSE CALCULATION MANUAL (ODCM)
INSTRUCTION SHEET**

The following instructional information and checklist are being furnished to help insert Revision 18 into the Comanche Peak Steam Electric Station ODCM.

Discard the old sheets and insert the new sheets, as listed below.

REMOVE

I 3/4-13

I 3/4-14

I B 3/4-1

EPL-1 through EPL-6

INSERT

I 3/4-13

I 3/4-14

I B 3/4-1

EPL-1 through EPL-6

Note: Following removal and insertion of the above pages, please update the Revision Change Sheet which should be maintained at the front of each ODCM (after Cover Sheet). The Revision Change Sheet is intended to provide useful historical evidence of maintaining each controlled copy of the ODCM.

OFFSITE DOSE CALCULATION MANUAL (ODCM)
EFFECTIVE PAGE LISTING

BELOW IS A LEGEND FOR THE EFFECTIVE PAGE LISTINGS:

Revision 0 (TXX-89118)	Submitted to the NRC March 2, 1989
Revision 1 (TXX-89595)	Submitted to the NRC August 25, 1989
Revision 2 (TXX-89711)	Submitted to the NRC November 27, 1989
Revision 3	April 10, 1990
Revision 4	October 9, 1990
Revision 5	December 20, 1990
Revision 6	July 3, 1991
Revision 7	December 4, 1991
Revision 7A	August 6, 1992
Revision 8 (Unit 2 Operations)	January 1, 1993
Revision 9	September 28, 1994
Revision 10	April 22, 1994
Revision 11	November 7, 1994
Revision 12	December 8, 1995
Revision 13	February 14, 1996
Revision 14	October 1, 1996
Revision 15	March 3, 1999
Revision 16	July 27, 1999
Revision 17	October 7, 1999
Revision 18	December 20, 1999
Revision 19	October 16, 2001

COMANCHE PEAK STEAM ELECTRIC STATION
OFFSITE DOSE CALCULATION MANUAL
EFFECTIVE PAGE LISTING

<u>Page No.</u>	<u>Revision No.</u>
Cover Sheet	16
i	16
ii	16
iii	9
iv	7/99
v	16
vi	8
vii	12
viii	16
ix	7/99
x	16
xi	8
xii	16
 <u>PART I</u>	
Divider Page	01/93
I 1-0	16
I 1-1	16
I 1-2	16
I 1-3	19
I 1-4	07/99
I 1-5	16
I 1-6	16
 I 2-0	 01/93
 I 3/4-0	 01/93
I 3/4-1	16
I 3/4-2	16
I 3/4-3	16
I 3/4-4	10
I 3/4-5	15
I 3/4-5a	4/94
I 3/4-6	9
I 3/4-7	13
I 3/4-8	16
I 3/4-9	01/93
I 3/4-10	01/93
I 3/4-11	01/93
I 3/4-12	8
I 3/4-13	18
I 3/4-14	18
I 3/4-15	01/93
I 3/4-16	01/93

COMANCHE PEAK STEAM ELECTRIC STATION
 OFFSITE DOSE CALCULATION MANUAL
 EFFECTIVE PAGE LISTING

<u>Page No.</u>	<u>Revision No.</u>
I 3/4-17	16
I 3/4-18	14
I 3/4-19	8
I 3/4-20	16
I 3/4-20a	14
I 3/4-21	16
I 3/4-22	16
I 3/4-22a	8
I 3/4-22b	8 ERRATA
I 3/4-23	16
I 3/4-24	01/93
I 3/4-25	01/93
I 3/4-26	16
I 3/4-27	16
I 3/4-28	16
I 3/4-29	16
I 3/4-30	16
I 3/4-31	8
I 3/4-32	16
I 3/4-33	12
I 3/4-34	01/93
I 3/4-35	01/93
I 3/4-36	01/93
I 3/4-37	14
I 3/4-38	15
I 3/4-39	8
I 3/4-40	01/93
I 3/4-41	01/93
I 3/4-42	01/93
I 3/4-43	01/93
I 3/4-44	16
I 3/4-45	12
IB 3/4-0	01/93
IB 3/4-1	18
IB 3/4-2	01/93
IB 3/4-3	12
IB 3/4-4	12
IB 3/4-5	8 ERRATA
IB 3/4-6	12
IB 3/4-7	12
IB 3/4-8	12
IB 3/4-9	8
IB 3/4-10	16

COMANCHE PEAK STEAM ELECTRIC STATION
OFFSITE DOSE CALCULATION MANUAL
EFFECTIVE PAGE LISTING

<u>Page No.</u>	<u>Revision No.</u>
IB 3/4-11	12
IB 3/4-12	01/93
I 5-0	01/93
I 5-1	12
I 5-2	8
I 6-0	01/93
I 6-1	12
I 6-2	16
I 6-3	16
I 6-4	16
 <u>PART II</u>	
Divider Page	01/93
II 1-1	14
II 1-2	12
II 1-3	8
II 1-4	12
II 1-5	12
II 1-6	12
II 1-7	12
II 1-8	12
II 1-9	15
II 1-9a	15
II 1-9b	15
II 1-10	8
II 1-11	8
II 1-12	8
II 1-13	8 ERRATA
II 1-14	8
II 1-15	8
II 1-16	01/93
II 1-17	15
II 1-18	12
II 1-19	14
II 1-20	8
II 1-21	16
II 1-22	16
II 1-23	8
II 1-24	14
II 1-25	12
II 1-26	01/93
II 1-27	01/93

COMANCHE PEAK STEAM ELECTRIC STATION
 OFFSITE DOSE CALCULATION MANUAL
 EFFECTIVE PAGE LISTING

<u>Page No.</u>	<u>Revision No.</u>
II 2-1	10
II 2-2	8
II 2-3	8
II 2-4	16
II 2-5	8
II 2-6	8
II 2-7	12
II 2-8	12
II 2-9	8
II 2-10	16
II 2-11	8
II 2-12	8
II 2-13	12
II 2-14	12
II 2-15	12
II 2-16	10
II 2-17	10
II 2-18	8
II 2-19	8
II 2-20	8
II 2-21	8
II 2-22	8 ERRATA
II 2-23	8
II 2-24	12
II 2-25	12
II 2-26	8 ERRATA
II 2-27	8
II 2-28	8
II 2-29	8
II 2-30	8
II 2-31	8
II 2-32	8
II 2-33	8
II 2-34	8
II 2-35	8
II 2-36	8
II 2-37	8
II 2-38	8
II 2-39	8
II 2-40	8
II 2-41	8
II 2-42	8
II 2-43	8

COMANCHE PEAK STEAM ELECTRIC STATION
OFFSITE DOSE CALCULATION MANUAL
EFFECTIVE PAGE LISTING

<u>Page No.</u>	<u>Revision No.</u>
II 2-44	8
II 2-45	8
II 2-46	8
II 2-47	8
II 2-48	8
II 2-49	8
II 2-50	12
II 2-51	12
II 2-52	01/93
II 2-53	01/93
II 2-54	01/93
II 2-55	01/93
II 2-56	01/93
II 3-1	16
II 3-2	16
II 3-3	12
II 3-4	12
II A-1	01/93
II B-1	01/93
II C-1	01/93
II D-1	01/93
II D-2	8
II E-1	01/93
II E-2	01/93
II F-1	01/93
II F-2	8
II G-1	8